

A Thesis/Project/Dissertation Report

on

STEGANOGRAPHY Software –

(Hide information in image)

*Submitted in partial fulfillment of the
requirement for the award of the degree of*

B.Tech. Computer Science and Engineering
Splz. Artificial Intelligence and Machine Learning



BT4440_RPT

Under The Supervision of
Name of Supervisor: Dr. Bharat Bhushan Naib
Designation: Associate Professor

Submitted By

Akash Khairal - 18SCSE1180065 / 18021180063
Himanshu -18SCSE1180013 / 18021180012

**SCHOOL OF COMPUTING SCIENCE AND ENGINEERING
DEPARTMENT OF COMPUTER SCIENCE AND ENGINEERING /
DEPARTMENT OF COMPUTER APPLICATION
GALGOTIAS UNIVERSITY, GREATER NOIDA
INDIA**

December, 2021



**SCHOOL OF COMPUTING SCIENCE AND
ENGINEERING
GALGOTIAS UNIVERSITY, GREATER NOIDA**

CANDIDATE'S DECLARATION

I/We hereby certify that the work which is being presented in the thesis/project/dissertation, entitled “**STEGANOGRAPHY SOFTWARE – [Hiding data in image].**” in partial fulfillment of the requirements for the award of the B. Tech Computer Science and Engineering-submitted in the School of Computing Science and Engineering of Galgotias University, Greater Noida, is an original work carried out during the period of July, 2021 to December,2021, under the supervision of Dr. Bharat Bhushan Naib, Associate Professor, Department of Computer Science and Engineering/Computer Application and Information and Science, of School of Computing Science and Engineering , Galgotias University, Greater Noida

The matter presented in the thesis/project/dissertation has not been submitted by me/us for the award of any other degree of this or any other places.

Akash Khairal, 18SCSE1180065

Himanshu, 18SCSE1180013

This is to certify that the above statement made by the candidates is correct to the best of my knowledge.

Supervisor Name

Designation

CERTIFICATE

The Final Thesis/Project/ Dissertation Viva-Voce examination of Akash Khairal, 18SCSE118005, Himanshu 18SCSE1180013 has been held on _____ and his/her work is recommended for the award of B.Tech. Computer Science and Engineering with Splz. in Artificial Intelligence and Machine Learning.

Signature of Examiner(s)

Signature of Supervisor(s)

Signature of Project Coordinator

Signature of Dean

Date: December, 2021

Place: Greater Noida

Acknowledgement

In completing this project report on project titled **Steganography Software – [Hiding Data in Image]**, we had to take the help and guideline of a few respected people, who deserve our greatest gratitude. The completion of this project report gives me much Pleasure. We would like to show our gratitude to **Dr. Bharat Bhushan Naib (Guide)** for giving us a good guideline for project throughout numerous consultations. We would also like to expand our deepest gratitude to all those who have directly and indirectly guided us in writing this project report. Many people, especially our classmates and friends themselves, have made valuable comments and suggestions on this proposal which gave us inspiration to improve our project. Here we thank all the people for their help directly and indirectly to complete this project report.

Date: December 18, 2021

Akash Khairal, 18SCSE1180065

Himanshu, 18SCSE1180013

Abstract

The former consists of linguistic or language forms of hidden writing. The later, such as invisible ink, try of hide messages physically. One disadvantage of linguistic steganography is that users must equip themselves to have a good knowledge of linguistry. Therefore, messages can be secretly carried by digital media by using the steganography techniques, and then be transmitted through the internet rapidly.

Abstract The former consists of linguistic or language forms of hidden writing. The later, such as invisible ink, try of hide messages physically. One disadvantage of linguistic steganography is that users must equip themselves to have a good knowledge of linguistry. Therefore, messages can be secretly carried by digital media by using the steganography techniques, and then be transmitted through the internet rapidly.

For hiding secret information in images, there exists a large variety of steganography techniques some are more complex than others and all of them have respective strong and weak points.

Our software is developed in C# using Visual Studio IDE.

Different applications may require absolute invisibility of the secret information, while others require a large secret message to be hidden.

This project intends to give an overview of image steganography, its uses and techniques. It also attempts to identify the requirements of a good steganography algorithm and briefly reflects on which steganographic techniques are more suitable for which applications.

Table of Contents

Title	PageNo.
Candidates Declaration	I
Acknowledgement	II
Abstract	III
Contents	IV
List of Figures	V
Acronyms	VI
Chapter 1 Introduction	1
1.1 What is Steganography?	2
1.2 History	3
1.2.1 Methodlogy	
1.3 Tools	
Chapter 2 Literature Survey/Project Design	5
Problem Statement	
Objective	
Chapter 3 Functionality/Working of Project	9
Overview	
Steganography vs Cryptography	
Steganography vs Watermarking	
Steganography Techniques	
Image Steganography	
Chapter 4 Results and Discussion	11
System Analysis and Design	
Encryption Process	
Decryption Process	
Code	
Chapter 5 Conclusion and Future Scope	41
5.1 Summary	41
5.2 Future Scope	42
Reference	43
Publication/Copyright/Product	45

List of Figures

Figure No.	Table Name	Page Number
1.	UML Diagram	7
2.	Data Flow Diagram	6

Acronyms

B.Tech.	Bachelor of Technology
M.Tech.	Master of Technology
BCA	Bachelor of Computer Applications
MCA	Master of Computer Applications
B.Sc. (CS)	Bachelor of Science in Computer Science
M.Sc. (CS)	Master of Science in Computer Science
SCSE	School of Computing Science and Engineering

CHAPTER-1

Introduction

One of the reasons that intruders can be successful is the most of the information they acquire from a system is in a form that they can read and comprehend. Intruders may reveal the information to others, modify it to misrepresent an individual or organization, or use it to launch an attack. One solution to this problem is, through the use of steganography. Steganography is a technique of hiding information in digital media. In contrast to cryptography, it is not to keep others from knowing the hidden information but it is to keep others from thinking that the information even exists.

Steganography become more important as more people join the cyberspace revolution. Steganography is the art of concealing information in ways that prevents the detection of hidden messages. Stegranography include an array of secret communication methods that hide the message from being seen or discovered.

Due to advances in ICT, most of information is kept electronically. Consequently, the security of information has become a fundamental issue. Besides cryptography, streganography can be employed to secure information. In cryptography, the message or encrypted message is embedded in a digital host before passing it through the network, thus the existence of the message is unknown. Besides hiding data for confidentiality, this approach of information hiding can be extended to copyright protection for digital media: audio, video and images.

The growing possibilities of modern communications need the special means of security especially on computer network. The network security is becoming more important as the number of data being exchanged on the internet increases. Therefore, the confidentiality and data integrity are requires to protect against unauthorized access and use. This has resulted in an explosive growth of the field of information hiding

Information hiding is an emerging research area, which encompasses applications such as copyright protection for digital media, watermarking, fingerprinting, and steganography.

In watermarking applications, the message contains information such as owner identification and a digital time stamp, which usually applied for copyright protection.

Fingerprint, the owner of the data set embeds a serial number that uniquely identifies the user of the data set. This adds to copyright information to makes it possible to trace any unauthorized used of the data set back to the user.

Steganography hide the secrete message within the host data set and presence imperceptible and is to be reliably communicated to a receiver. The host data set is purposely corrupted, but in a covert way, designed to be invisible to an information analysis.

SYNOPSIS

Project Name: STEGANOGRAPHY SOFTWARE- [Hiding Data in Image]

Project Members:

This project is done in a group of two people. Project members are.

1. Akash Khairal
2. Himanshu

What is Steganography?

Steganography is the practice of hiding private or sensitive information within something that appears to be nothing out to the usual. Steganography is often confused with cryptology because the two are similar in the way that they both are used to protect important information. The difference between two is that steganography involves hiding information so it appears that no information is hidden at all. If a person or persons views the object that the information is hidden inside of he or she will have no idea that there is any hidden information, therefore the person will not attempt to decrypt the information.

What steganography essentially does is exploit human perception, human senses are not trained to look for files that have information inside of them, although this software is available that can do what is called Steganography. The most common use of steganography is to hide a file inside another file.

History of Steganography:

Through out history Steganography has been used to secretly communicate information between people.

Some examples of use of Steganography is past times are:

1. During World War 2 invisible ink was used to write information on pieces of paper so that the paper appeared to the average person as just being blank pieces of paper. Liquids such as milk, vinegar and fruit juices were used, because when each one of these substances are heated they darken and become visible to the human eye.
2. In Ancient Greece they used to select messengers and shave their head, they would then write a message on their head. Once the message had been written the hair was allowed to grow back. After the hair grew back the messenger was sent to deliver the message, the recipient would shave off the messengers hair to see the secrete message.
3. Another method used in Greece was where someone would peel wax off a tablet that was

Why This Steganography?

This technique is chosen, because this system includes not only imperceptibility but also un-delectability by any steganalysis tool.

Project Scope:

This project is developed for hiding information in any image file. The scope of the project is implementation of steganography tools for hiding information includes any type of information file and image files and the path where the user wants to save Image and extruded file.

Methodology:

User needs to run the application. The user has two tab options - encrypt and decrypt. If user select encrypt, application give the screen to select image file, information file and option to save the image file. If user select decrypt, application gives the screen to select only image file and ask path where user want to save the secrete file.

This project has two methods - Encrypt and Decrypt.

In encryption the secrete information is hiding in with any type of image file.

Decryption is getting the secrete information from image file.

Software Requirements:

- .NET Framework 3.5

Hardware Requirements:

Processor: Preferably 1.0 GHz or Greater.

RAM : 512 MB or Greater.

Limitations of the Software:

This project has an assumption that is both the sender and receiver must have shared some secret information before imprisonment. Pure steganography means that there is none prior information shared by two communication parties.

Detecting Steganography:

The art of detecting Steganography is referred to as **Steganalysis**.

To put it simply Steganalysis involves detecting the use of Steganography inside of a file. Steganalysis does not deal with trying to decrypt the hidden information inside of a file, just discovering it.

There are many methods that can be used to detect Steganography such as:

“Viewing the file and comparing it to another copy of the file found on the Internet (Picture file). There are usually multiple copies of images on the internet, so you may want to look for several of them and try and compare the suspect file to them. For example if you download a JPEG and your suspect file is also a JPEG and the two files look almost identical apart from the fact that one is larger than the other, it is most probable your suspect file has hidden information inside of it.

Future Enhancements:

To make it pure steganography application.

Problem Statement:

The former consists of linguistic or language forms of hidden writing. The later, such as invisible ink, try of hide messages physically. One disadvantage of linguistic steganography is that users must equip themselves to have a good knowledge of linguistry. In recent years, everything is trending toward digitization. And with the development of the internet technology, digital media can be transmitted conveniently over the network. Therefore, messages can be secretly carried by digital media by using the steganography techniques, and then be transmitted through the internet rapidly

Steganography is the art of hiding the fact that communication is taking place, by hiding information in other information. Many different carrier file formats can be used, but digital images are the most popular because of their frequency on the internet. For hiding secret information in images, there exists a large variety of steganography techniques some are more complex than others and all of them have respective strong and weak points.

So we prepare this application, to make the information hiding more simple and user friendly.

Objective

The goal of steganography is covert communication. So, a fundamental requirement of this steganography system is that the hidden message carried by stego-media should not be sensible to human beings.

The other goal of steganography is to avoid drawing suspicion to the existence of a hidden message. This approach of information hiding technique has recently become important in a number of application areas.

This project has following objectives:

- To produce a security tool based on steganography techniques.
- To explore techniques of hiding data using an encryption module of this project.
- To extract techniques of getting secret data using a decryption module.

Steganography is sometimes used when encryption is not permitted. Or, more commonly, steganography is used to supplement encryption. An encrypted file may still hide information using steganography, so even if the encrypted file is deciphered, the hidden message is not seen.

Overview

The word steganography comes from the Greek “Seganos”, which mean covered or secret and - “graphy” mean writing or drawing. Therefore, steganography mean, literally, covered writing. It is the art and science of hiding information such its presence cannot be detected and a communication is happening. A secrete information is encoding in a manner such that the very existence of the information is concealed. Paired with existing communication methods, steganography can be used to carry out hidden exchanges.

The main goal of this projects it to communicate securely in a completely undetectable manner and to avoid drawing suspicion to the transmission of a hider data. There has been a rapid growth of interest in steganography for two reasons:

The publishing and broadcasting industries have become interested in techniques for hiding encrypted copyright marks and serial numbers in digital films, audio recordings, books and multimedia products

Moves by various governments to restrict the availability of encryption services have motivated people to study methods by which private messages can be embedded in seemingly innocuous cover messages.

The basic model of steganography consists of Carrier, Message and password. Carrier is also known as cover-object, which the message is embedded and serves to hide the presence of the message.

Basically, the model for steganography is shown on following figure:

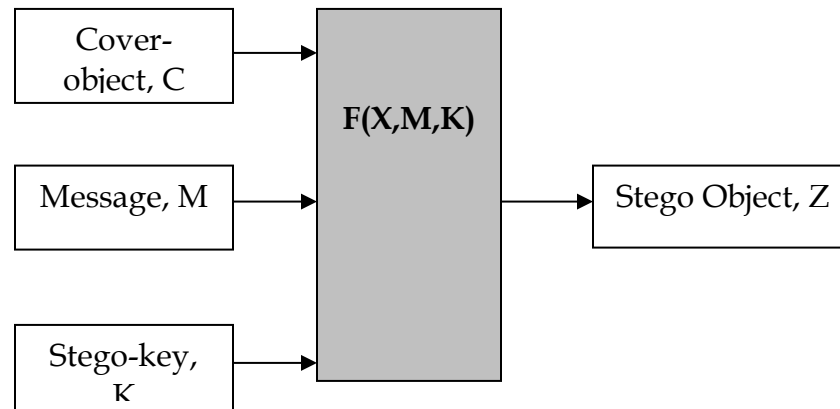

Message is the data that the sender wishes to remain it confidential. It can be plain text, ciphertext, other image, or anything that can be embedded in a bit stream such as a copyright mark, a covert communication, or a serial number. Password is known as *stego-key*, which ensures that only recipient who know the corresponding decoding key will be able to extract the message from a *cover-object*. The *cover-object* with the secretly embedded message is then called the *Stego-object*.

Recovering message from a *stego-object* requires the *cover-object* itself and a corresponding decoding key if a *stego-key* was used during the encoding process. The original image may or may not be required in most applications to extract the message.

There are several suitable carriers below to be the *cover-object*:

- Network protocols such as TCP, IP and UDP
- Audio that using digital audio formats such as wav, midi, avi, mpeg, mpi and voc
- File and Disk that can hides and append files by using the slack space
- Text such as null characters, just alike morse code including html and java
- Images file such as bmp, gif and jpg, where they can be both color and gray-scale.

In general, the information hiding process extracts redundant bits from *cover-object*. The process consists of two steps:

- Identification of redundant bits in a *cover-object*. Redundant bits are those bits that can be modified without corrupting the quality or destroying the integrity of the *cover-object*.
- Embedding process then selects the subset of the redundant bits to be replaced with data from a secret message. The *stego-object* is created by replacing the selected redundant bits with message bits

Steganography vs Cryptography:

Basically, the purpose of cryptography and steganography is to provide secret communication. However, steganography is not the same as cryptography. Cryptography hides the contents of a secret message from malicious people, whereas steganography even conceals the existence of the message. In cryptography, the system is broken when the attacker can read the secret message. Breaking a steganography system needs the attacker to detect that steganography has been used.

It is possible to combine the techniques by encrypting a message using cryptography and then hiding the encrypted message using steganography. The resulting stego-image can be transmitted without revealing that secret information is being exchanged.

Steganography vs Watermarking:

Steganography pay attention to the degree of Invisibility while watermarking pay most of its attribute to the robustness of the message and its ability to withstand attacks of removal, such as image operations(rotation, cropping, filtering), audio operations(rerecording, filtering)in the case of images and audio files being watermarked respectively.

It is a non-questionable fact that delectability of a vessel with an introduced data (steganographic message or a watermark) is a function of the changeability function of the algorithm over the vessel.

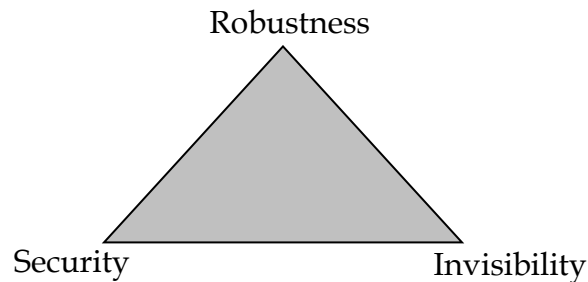

That is the way the algorithm changes the vessel and the severity of such an operation determines with no doubt the delectability of the message, since delectability is a function of file characteristics deviation from the norm, embedding operation attitude and change severity of such change decides vessel file delectability.

A typical triangle of conflict is message Invisibility, Robustness, and Security. Invisibility is a measure of the in notability of the contents of the message within the vessel. Security is sinominous to the cryptographic idea to message security, meaning inability of reconstruction of the message without the proper secret key material shared.

Robustness refers to the endurance capability of the message to survive distortion or removal attacks intact. It is often used in the watermarking field since watermarking seeks the persistence of the watermark over attacks, steganographic messages on the other hand tend to be of high sensitivity to such attacks. The more invisible the message is the less secure it is (cryptography needs space) and the less robust it is (no error checking/recovery introduced). The more robust the message is embedded the more size it requires and the more visible it is.

Steganography Techniques:

Over the past few years, numerous steganography techniques that embed hidden messages in multimedia objects have been proposed. There have been many techniques for hiding information or messages in images in such a manner that alteration made to the image is perceptually indiscernible. Commonly approaches are include LSB, Masking and filtering and Transform techniques.

Least significant bit (LSB) insertion is a simple approach to embedding information in image file. The simplest steganography techniques embed the bits of the message directly into least significant bit plane of the cover-image in a deterministic sequence. Modulating the least significant bit does not result in human perceptible difference because the amplitude of the change is small. In this technique, the embedding capacity can be increased by using two or more least significant bits. At the same time, not only the risk of making the embedded message statistically detectable increase but also the image fidelity degrades. Hence a variable size LSB embedding schema is presented, in which the number of LSBs used for message embedding/extracting depends on the local characteristics of the pixel. The advantage of LSB-based method is easy to implement and high message pay-load.

Although LSB hides the message in such way that the humans do not perceive it, it is still possible for the opponent to retrieve the message due to the simplicity of the technique. Therefore, malicious people can easily try to extract the message from the beginning of the image if they are suspicious that there exists secret information that was embedded in the image.

Therefore, a system named Secure Information Hiding System (SIHS) is proposed to improve the LSB scheme. It overcomes the sequence-mapping problem by embedding the message into a set of random pixels, which are scattered on the cover-image.

Masking and filtering techniques, usually restricted to 24 bits and gray scale image, hide information by marking an image, in a manner similar to paper watermarks. The technique perform analysis of the image, thus embed the information in significant areas

so that the hidden message is more integral to cover image than just hiding it in the noise level.

Transform techniques embed the message by modulating coefficient in a transform domain, such as the Discrete Fourier Transform, or Wavelet Transform. These methods hide messages in significant areas of the cover image, which make them more robust to attack. Transformations can be applied over the entire image, to block throughout the image, or other variant.

Image Steganography and bitmap pictures:

Using bitmap pictures for hiding secret information is one of most popular choices for Steganography. Many types of software built for this purpose, some of these software use password protection to encrypting information on picture. To use these software you must have a 'BMP' format of a pictures to use it, but using other type of pictures like "JPEG", "GIF" or any other types is rather or never used, because of algorithm of "BMP" pictures for Steganography is simple. Also we know that in the web most popular of image types are "JPEG" and other types not "BPM", so we should have a solution for this problem.

This software provide the solution of this problem, it can accept any type of image to hide information file, but finally it give the only "BMP" image as an output that has hidden file inside it.

Bitmap Steganography:

Bitmap type is the simplest type of picture because that it doesn't have any technology for decreasing file size. Structure of these files is that a bitmap image created from pixels that any pixel created from three colors (red, green and blue said RGB) each color of a pixel is one byte information that shows the density of that color. Merging these three color makes every color that we see in these pictures. We know that every byte in computer science is created from 8 bit that first bit is Most-Significant-Bit (MSB) and last bit Least-Significant-Bit (LSB), the idea of using Steganography science is in this place; we use LSB bit for writing our security information inside BMP pictures. So if we just use last layer (8st layer) of information, we should change the last bit of pixels, in other hands we have 3 bits in each pixel so we have $3 \times \text{height} \times \text{width}$ bits memory to write our information. But before writing our data we must write name of data(file), size of name of data & size of data. We can do this by assigning some first bits of memory (8st layer).

(00101101	0001110 <u>1</u>	11011100)
(10100110	1100010 <u>1</u>	00001100)
(11010010	1010110 <u>0</u>	01100011)

Using each 3 pixel of picture to save a byte of data

System Analysis & Design

Steganography system requires any type of image file and the information or message that is to be hidden. It has two modules encrypt and decrypt.

Microsoft .Net framework prepares a huge amount of tool and options for programmers that they simples programming. One of .Net tools for pictures and images is auto-

converting most types of pictures to BMP format. I used this tool in this software called "Steganography" that is written in C#.Net language and you can use this software to hide your information in any type of pictures without any converting its format to BMP (software converts inside it).

The algorithm used for Encryption and Decryption in this application provides using several layers lieu of using only LSB layer of image. Writing data starts from last layer (8st or LSB layer); because significant of this layer is least and every upper layer has doubled significant from its down layer. So every step we go to upper layer image quality decreases and image retouching transpires.

The encrypt module is used to hide information into the image; no one can see that information or file. This module requires any type of image and message and gives the only one image file in destination.

The decrypt module is used to get the hidden information in an image file. It take the image file as an output, and give two file at destination folder, one is the same image file and another is the message file that is hidden it that.

Before encrypting file inside image we must save name and size of file in a definite place of image. We could save file name before file information in LSB layer and save file size and file name size in most right-down pixels of image. Writing this information is needed to retrieve file from encrypted image in decryption state.

The graphical representation of this system is as follows:

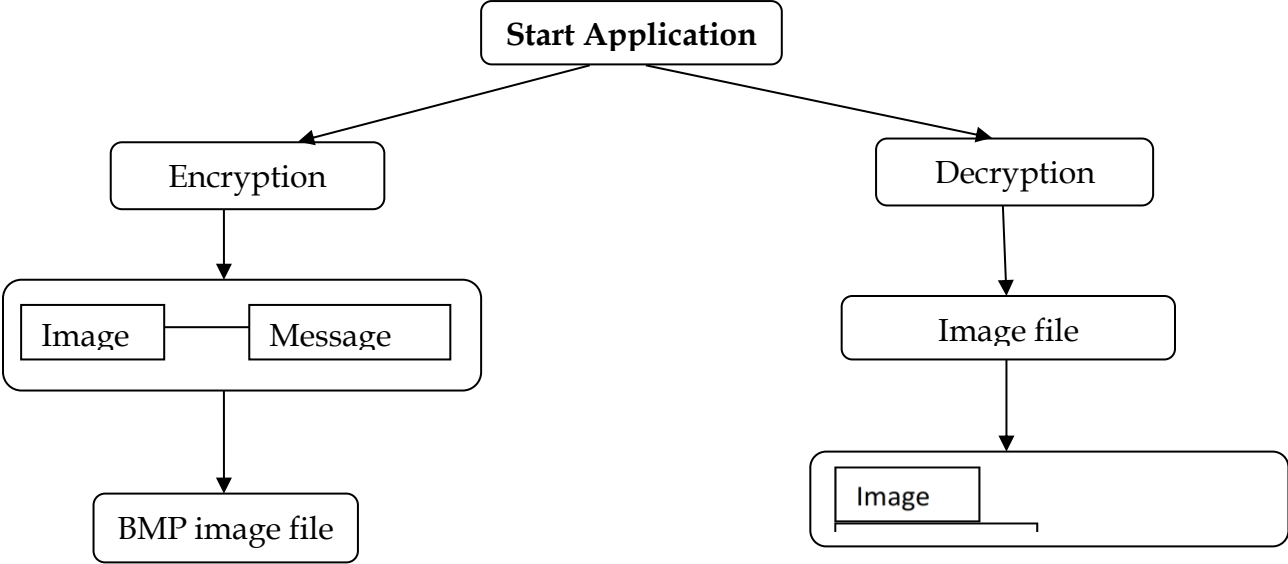

Encryption Process

IMAGE FILE



INFORMATION FILE

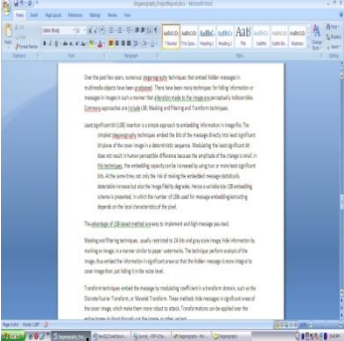

BMP FILE

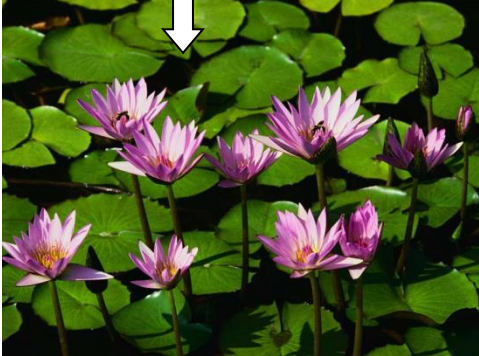

Decryption Process

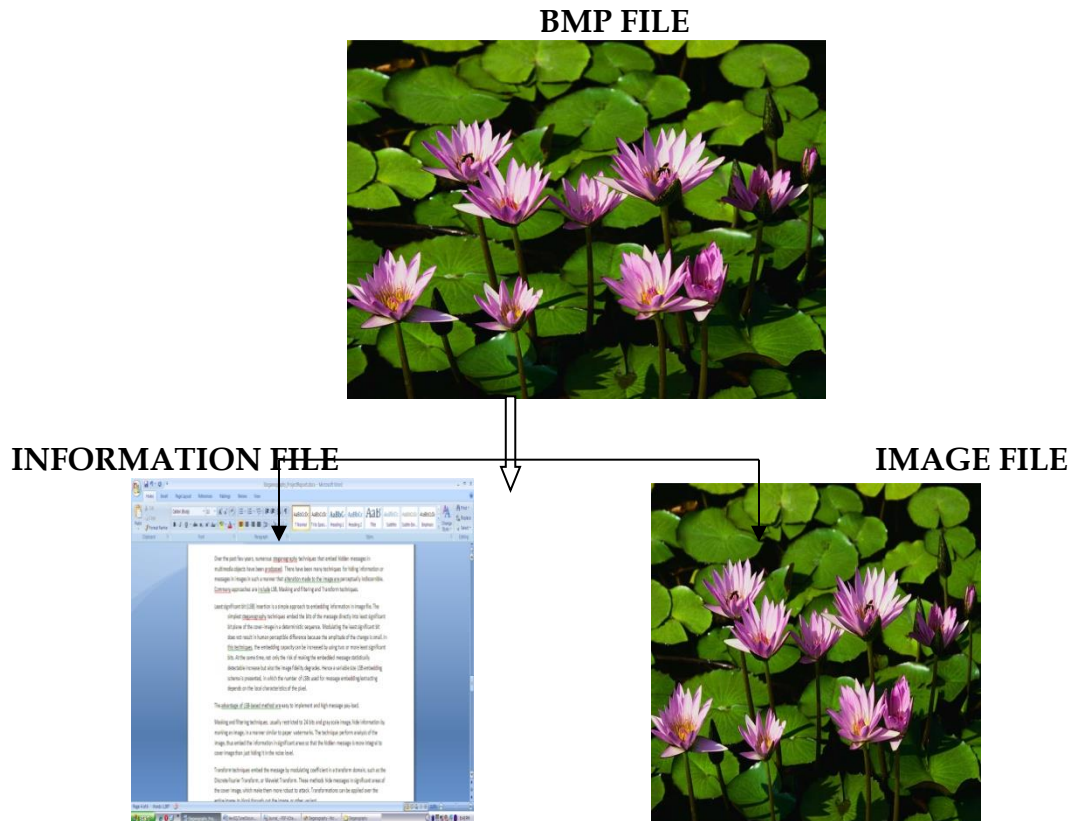

Code Analysis

```
using System;
using System.Drawing;
using System.Windows.Forms;
using System.IO;

namespace Text2Image
{
    public partial class FrmSteganography : Form
    {
        public FrmSteganography()
        {
            InitializeComponent();
        }
    }
}
```

```

    //public values:
    string loadedTrueImagePath, loadedFilePath,
saveToImage, DLoadImagePath, DSaveFilePath;
    int height, width;
    long fileSize, fileNameSize;
    Image loadedTrueImage, DecryptedImage ,AfterEncryption;
    Bitmap loadedTrueBitmap, DecryptedBitmap;
    Rectangle previewImage = new Rectangle(20,160,490,470);
    bool canPaint = false, EncriptionDone = false;
    byte[] fileContainer;

private void EnImageBrowse_btn_Click(object sender, EventArgs e)
{
    if (openFileDialog1.ShowDialog() == DialogResult.OK)
    {
        loadedTrueImagePath = openFileDialog1.FileName;
        EnImage_tbx.Text = loadedTrueImagePath;
        loadedTrueImage = Image.FromFile(loadedTrueImagePath);
        height = loadedTrueImage.Height;
        width = loadedTrueImage.Width;
        loadedTrueBitmap = new Bitmap(loadedTrueImage);

        FileInfo imginf = new FileInfo(loadedTrueImagePath);
        float fs = (float)imginf.Length / 1024;
        ImageSize_lbl.Text = smalldecimal(fs.ToString(), 2) + " KB";
        ImageHeight_lbl.Text = loadedTrueImage.Height.ToString() + "
Pixel";
        ImageWidth_lbl.Text = loadedTrueImage.Width.ToString() + "
Pixel";
        double cansave = (8.0 * ((height * (width / 3) * 3) / 3 - 1))
/ 1024;
        CanSave_lbl.Text = smalldecimal(cansave.ToString(), 2) + "
KB";

        canPaint = true;
        this.Invalidate();
    }
}

private string smalldecimal(string inp, int dec)
{
    int i;
    for (i = inp.Length - 1; i > 0; i--)
        if (inp[i] == '.')
            break;
    try
    {
        return inp.Substring(0, i + dec + 1);
    }
    catch
    {
        return inp;
    }
}

private void EnFileBrowse_btn_Click(object sender, EventArgs e)
{

```

```

        if (openFileDialog2.ShowDialog() == DialogResult.OK)
        {
            loadedFilePath = openFileDialog2.FileName;
            EnFile_tbx.Text = loadedFilePath;
            FileInfo finfo = new FileInfo(loadedFilePath);
            fileSize = finfo.Length;
            fileNameSize = justFName(loadedFilePath).Length;
        }
    }

private void Encrypt_btn_Click(object sender, EventArgs e)
{
    if (saveFileDialog1.ShowDialog() == DialogResult.OK)
    {
        saveToImage = saveFileDialog1.FileName;
    }
    else
        return;
    if (EnImage_tbx.Text == String.Empty || EnFile_tbx.Text ==
String.Empty)
    {
        MessageBox.Show("Encrypton information is incomplete!\nPlease
complete them frist.", "Error", MessageBoxButtons.OK, MessageBoxIcon.Error);
    }
    if (8*((height * (width/3)*3)/3 - 1) < fileSize + fileNameSize)
    {
        MessageBox.Show("File size is too large!\nPlease use a larger
image to hide this file.", "Error", MessageBoxButtons.OK,
MessageBoxIcon.Error);
        return;
    }
    fileContainer = File.ReadAllBytes(loadedFilePath);
    EncryptLayer();
}

private void EncryptLayer()
{
    toolStripStatusLabel1.Text = "Encrypting... Please wait";
    Application.DoEvents();
    long FSize = fileSize;
    Bitmap changedBitmap = EncryptLayer(8, loadedTrueBitmap, 0,
(height * (width/3)*3) / 3 - fileNameSize - 1, true);
    FSize -= (height * (width / 3) * 3) / 3 - fileNameSize - 1;
    if(FSize > 0)
    {
        for (int i = 7; i >= 0 && FSize > 0; i--)
        {
            changedBitmap = EncryptLayer(i, changedBitmap, ((8 - i)
* height * (width / 3) * 3) / 3 - fileNameSize - (8 - i)), ((9 - i) * height
* (width / 3) * 3) / 3 - fileNameSize - (9 - i)), false);
            FSize -= (height * (width / 3) * 3) / 3 - 1;
        }
    }
    changedBitmap.Save(saveToImage);
    toolStripStatusLabel1.Text = "Encrypted image has been
successfully saved.";
}

```

```

        EncryptionDone = true;
        AfterEncryption = Image.FromFile(saveToImage);
        this.Invalidate();
    }

    private Bitmap EncryptLayer(int layer, Bitmap inputBitmap, long
startPosition, long endPosition, bool writeFileName)
    {
        Bitmap outputBitmap = inputBitmap;
        layer--;
        int i = 0, j = 0;
        long FNSize = 0;
        bool[] t = new bool[8];
        bool[] rb = new bool[8];
        bool[] gb = new bool[8];
        bool[] bb = new bool[8];
        Color pixel = new Color();
        byte r, g, b;

        if (writeFileName)
        {
            FNSize = fileNameSize;
            string fileName = justFName(loadedFilePath);

            //write fileName:
            for (i = 0; i < height && i * (height / 3) < fileNameSize;
i++)
                for (j = 0; j < (width / 3) * 3 && i * (height / 3) + (j
/ 3) < fileNameSize; j++)
                    {
                        byte2bool((byte)fileName[i * (height / 3) + j / 3],
ref t);

                        pixel = inputBitmap.GetPixel(j, i);
                        r = pixel.R;
                        g = pixel.G;
                        b = pixel.B;
                        byte2bool(r, ref rb);
                        byte2bool(g, ref gb);
                        byte2bool(b, ref bb);
                        if (j % 3 == 0)
                        {
                            rb[7] = t[0];
                            gb[7] = t[1];
                            bb[7] = t[2];
                        }
                        else if (j % 3 == 1)
                        {
                            rb[7] = t[3];
                            gb[7] = t[4];
                            bb[7] = t[5];
                        }
                        else
                        {
                            rb[7] = t[6];
                            gb[7] = t[7];
                        }
                    }
                }
    }

```

```

        Color result = Color.FromArgb((int)bool2byte(rb),
(int)bool2byte(gb), (int)bool2byte(bb));
        outputBitmap.SetPixel(j, i, result);
    }
    i--;
}
//write file (after file name):
int tempj = j;

for (; i < height && i * (height / 3) < endPosition -
startPosition + FNSize && startPosition + i * (height / 3) < fileSize +
FNSize; i++)
    for (j = 0; j < (width / 3) * 3 && i * (height / 3) + (j / 3)
< endPosition - startPosition + FNSize && startPosition + i * (height / 3) +
(j / 3) < fileSize + FNSize; j++)
    {
        if (tempj != 0)
        {
            j = tempj;
            tempj = 0;
        }
        byte2bool((byte)fileContainer[startPosition + i * (height
/ 3) + j / 3 - FNSize], ref t);
        pixel = inputBitmap.GetPixel(j, i);
        r = pixel.R;
        g = pixel.G;
        b = pixel.B;
        byte2bool(r, ref rb);
        byte2bool(g, ref gb);
        byte2bool(b, ref bb);
        if (j % 3 == 0)
        {
            rb[layer] = t[0];
            gb[layer] = t[1];
            bb[layer] = t[2];
        }
        else if (j % 3 == 1)
        {
            rb[layer] = t[3];
            gb[layer] = t[4];
            bb[layer] = t[5];
        }
        else
        {
            rb[layer] = t[6];
            gb[layer] = t[7];
        }
        Color result = Color.FromArgb((int)bool2byte(rb),
(int)bool2byte(gb), (int)bool2byte(bb));
        outputBitmap.SetPixel(j, i, result);
    }

}
long tempFS = fileSize, tempFNS = fileNameSize;
r = (byte)(tempFS % 100);
tempFS /= 100;
g = (byte)(tempFS % 100);
tempFS /= 100;

```

```

        b = (byte)(tempFS % 100);
        Color flenColor = Color.FromArgb(r,g,b);
        outputBitmap.SetPixel(width - 1, height - 1, flenColor);

        r = (byte)(tempFNS % 100);
        tempFNS /= 100;
        g = (byte)(tempFNS % 100);
        tempFNS /= 100;
        b = (byte)(tempFNS % 100);
        Color fnlenColor = Color.FromArgb(r,g,b);
        outputBitmap.SetPixel(width - 2, height - 1, fnlenColor);

        return outputBitmap;
    }

private void DecryptLayer()
{
    toolStripStatusLabel1.Text = "Decrypting... Please wait";
    Application.DoEvents();
    int i, j = 0;
    bool[] t = new bool[8];
    bool[] rb = new bool[8];
    bool[] gb = new bool[8];
    bool[] bb = new bool[8];
    Color pixel = new Color();
    byte r, g, b;
    pixel = DecryptedBitmap.GetPixel(width - 1, height - 1);
    long fSize = pixel.R + pixel.G * 100 + pixel.B * 10000;
    pixel = DecryptedBitmap.GetPixel(width - 2, height - 1);
    long fNameSize = pixel.R + pixel.G * 100 + pixel.B * 10000;
    byte[] res = new byte[fSize];
    string resFName = "";
    byte temp;

    //Read file name:
    for (i = 0; i < height && i * (height / 3) < fNameSize; i++)
        for (j = 0; j < (width / 3) * 3 && i * (height / 3) + (j / 3)
< fNameSize; j++)
        {
            pixel = DecryptedBitmap.GetPixel(j, i);
            r = pixel.R;
            g = pixel.G;
            b = pixel.B;
            byte2bool(r, ref rb);
            byte2bool(g, ref gb);
            byte2bool(b, ref bb);
            if (j % 3 == 0)
            {
                t[0] = rb[7];
                t[1] = gb[7];
                t[2] = bb[7];
            }
            else if (j % 3 == 1)
            {
                t[3] = rb[7];
                t[4] = gb[7];
            }
        }
    }
}

```

```

        t[5] = bb[7];
    }
    else
    {
        t[6] = rb[7];
        t[7] = gb[7];
        temp = bool2byte(t);
        resFName += (char)temp;
    }
}

//Read file on layer 8 (after file name):
int tempj = j;
i--;

for (; i < height && i * (height / 3) < fSize + fNameSize; i++)
    for (j = 0; j < (width / 3) * 3 && i * (height / 3) + (j / 3)
< (height * (width / 3) * 3) / 3 - 1 && i * (height / 3) + (j / 3) < fSize +
fNameSize; j++)
    {
        if (tempj != 0)
        {
            j = tempj;
            tempj = 0;
        }
        pixel = DecryptedBitmap.GetPixel(j, i);
        r = pixel.R;
        g = pixel.G;
        b = pixel.B;
        byte2bool(r, ref rb);
        byte2bool(g, ref gb);
        byte2bool(b, ref bb);
        if (j % 3 == 0)
        {
            t[0] = rb[7];
            t[1] = gb[7];
            t[2] = bb[7];
        }
        else if (j % 3 == 1)
        {
            t[3] = rb[7];
            t[4] = gb[7];
            t[5] = bb[7];
        }
        else
        {
            t[6] = rb[7];
            t[7] = gb[7];
            temp = bool2byte(t);
            res[i * (height / 3) + j / 3 - fNameSize] = temp;
        }
    }

//Read file on other layers:
long readedOnL8 = (height * (width/3)*3) /3 - fNameSize - 1;

```

```

        for (int layer = 6; layer >= 0 && readedOnL8 + (6 - layer) *
((height * (width / 3) * 3) / 3 - 1) < fSize; layer--)
            for (i = 0; i < height && i * (height / 3) + readedOnL8 + (6
- layer) * ((height * (width / 3) * 3) / 3 - 1) < fSize; i++)
                for (j = 0; j < (width / 3) * 3 && i * (height / 3) + (j
/ 3) + readedOnL8 + (6 - layer) * ((height * (width / 3) * 3) / 3 - 1) <
fSize; j++)
                    {
                        pixel = DecryptedBitmap.GetPixel(j, i);
                        r = pixel.R;
                        g = pixel.G;
                        b = pixel.B;
                        byte2bool(r, ref rb);
                        byte2bool(g, ref gb);
                        byte2bool(b, ref bb);
                        if (j % 3 == 0)
                            {
                                t[0] = rb[layer];
                                t[1] = gb[layer];
                                t[2] = bb[layer];
                            }
                        else if (j % 3 == 1)
                            {
                                t[3] = rb[layer];
                                t[4] = gb[layer];
                                t[5] = bb[layer];
                            }
                        else
                            {
                                t[6] = rb[layer];
                                t[7] = gb[layer];
                                temp = bool2byte(t);
                                res[i * (height / 3) + j / 3 + (6 - layer) *
((height * (width / 3) * 3) / 3 - 1) + readedOnL8] = temp;
                            }
                    }

                if (File.Exists(DSaveFilePath + "\\\" + resFName))
                    {
                        MessageBox.Show("File \"" + resFName + "\" already exist
please choose another path to save file",
"Error", MessageBoxButtons.OK, MessageBoxIcon.Error);
                        return;
                    }
                else
                    {
                        File.WriteAllBytes(DSaveFilePath + "\\\" + resFName, res);
                        toolStripStatusLabel1.Text = "Decrypted file has been
successfully saved.";
                        Application.DoEvents();
                    }
            }

private void byte2bool(byte inp, ref bool[] outp)
{
    if(inp>=0 && inp<=255)
        for (short i = 7; i >= 0; i--)
            {
                if (inp % 2 == 1)

```



```

        outp[i] = true;
    else
        outp[i] = false;
    inp /= 2;
}
else
    throw new Exception("Input number is illegal.");
}

private byte bool2byte(bool[] inp)
{
    byte outp = 0;
    for (short i = 7; i >= 0; i--)
    {
        if (inp[i])
            outp += (byte)Math.Pow(2.0, (double)(7-i));
    }
    return outp;
}

private void Decrypt_btn_Click(object sender, EventArgs e)
{
    if (DeSaveFile_tbx.Text == String.Empty || DeLoadImage_tbx.Text
    == String.Empty)
    {
        MessageBox.Show("Text boxes must not be empty!", "Error",
        MessageBoxButtons.OK, MessageBoxIcon.Error);

        return;
    }

    if (System.IO.File.Exists(DeLoadImage_tbx.Text) == false)
    {
        MessageBox.Show("Select image file.", "Error",
        MessageBoxButtons.OK, MessageBoxIcon.Exclamation);
        DeLoadImage_tbx.Focus();
        return;
    }

    DecryptLayer();
}

private void DeLoadImageBrowse_btn_Click(object sender, EventArgs e)
{
    if (openFileDialog3.ShowDialog() == DialogResult.OK)
    {
        DLoadImagePath = openFileDialog3.FileName;
        DeLoadImage_tbx.Text = DLoadImagePath;
        DecryptedImage = Image.FromFile(DLoadImagePath);
        height = DecryptedImage.Height;
        width = DecryptedImage.Width;
        DecryptedBitmap = new Bitmap(DecryptedImage);
    }
}

```

```

        FileInfo imginf = new FileInfo(DLoadImagePath);
        float fs = (float)imginf.Length / 1024;
        ImageSize_lbl.Text = smalldecimal(fs.ToString(), 2) + " KB";
        ImageHeight_lbl.Text = DecryptedImage.Height.ToString() + "
Pixel";
        ImageWidth_lbl.Text = DecryptedImage.Width.ToString() + "
Pixel";
        double cansave = (8.0 * ((height * (width / 3) * 3) / 3 - 1))
/ 1024;
        CanSave_lbl.Text = smalldecimal(cansave.ToString(), 2) + "
KB";

        canPaint = true;
        this.Invalidate();
    }
}

private void DeSaveFileBrowse_btn_Click(object sender, EventArgs e)
{
    if (folderBrowserDialog1.ShowDialog() == DialogResult.OK)
    {
        DSaveFilePath = folderBrowserDialog1.SelectedPath;
        DeSaveFile_tbx.Text = DSaveFilePath;
    }
}

private void Form1_Paint(object sender, PaintEventArgs e)
{
    if(canPaint)
        try
        {
            if (!EncriptionDone)
                e.Graphics.DrawImage(loadedTrueImage, previewImage);
            else
                e.Graphics.DrawImage(AfterEncryption, previewImage);
        }
        catch
        {
            e.Graphics.DrawImage(DecryptedImage, previewImage);
        }
}

private string justFName(string path)
{
    string output;
    int i;
    if (path.Length == 3) // i.e: "C:\\"
        return path.Substring(0, 1);
    for (i = path.Length - 1; i > 0; i--)
        if (path[i] == '\\')
            break;
    output = path.Substring(i + 1);
    return output;
}

private string justEx(string fName)

```

```
{
    string output;
    int i;
    for (i = fName.Length - 1; i > 0; i--)
        if (fName[i] == '.')
            break;
    output = fName.Substring(i + 1);
    return output;
}

private void Close_btn_Click(object sender, EventArgs e)
{
    this.Close();
}

private void linkLabel1_LinkClicked(object sender,
LinkLabelLinkClickedEventArgs e)
{
    System.Diagnostics.Process.Start("http:\\\\www.programmer2programmer.net");
}
}
```

User Manual

This is the first screen which has two tab options – one is Encrypt Image for encryption and another is Decrypt image for decryption. In right – top panel is displays the information about the image such as size, height and width.

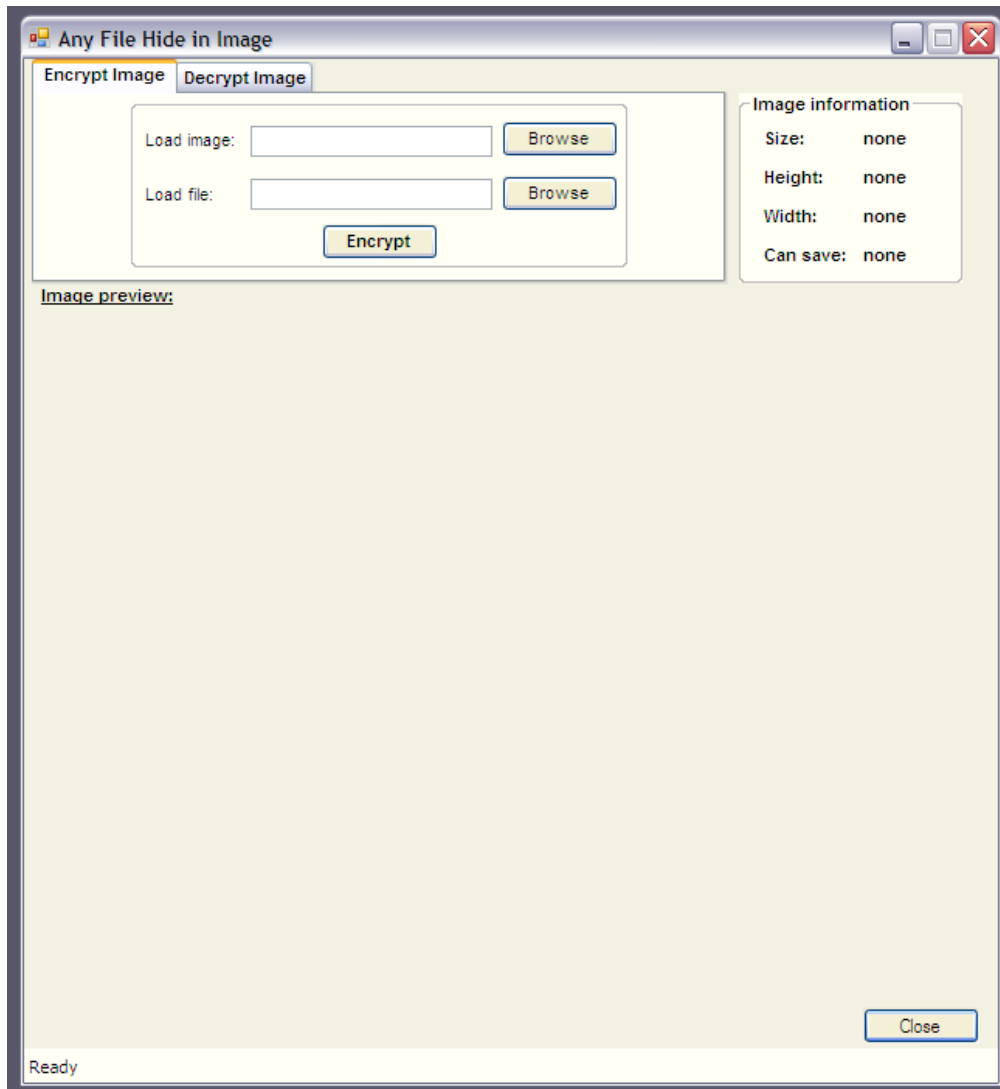

Encryption

1. For Encryption select Encrypt Image tab option.

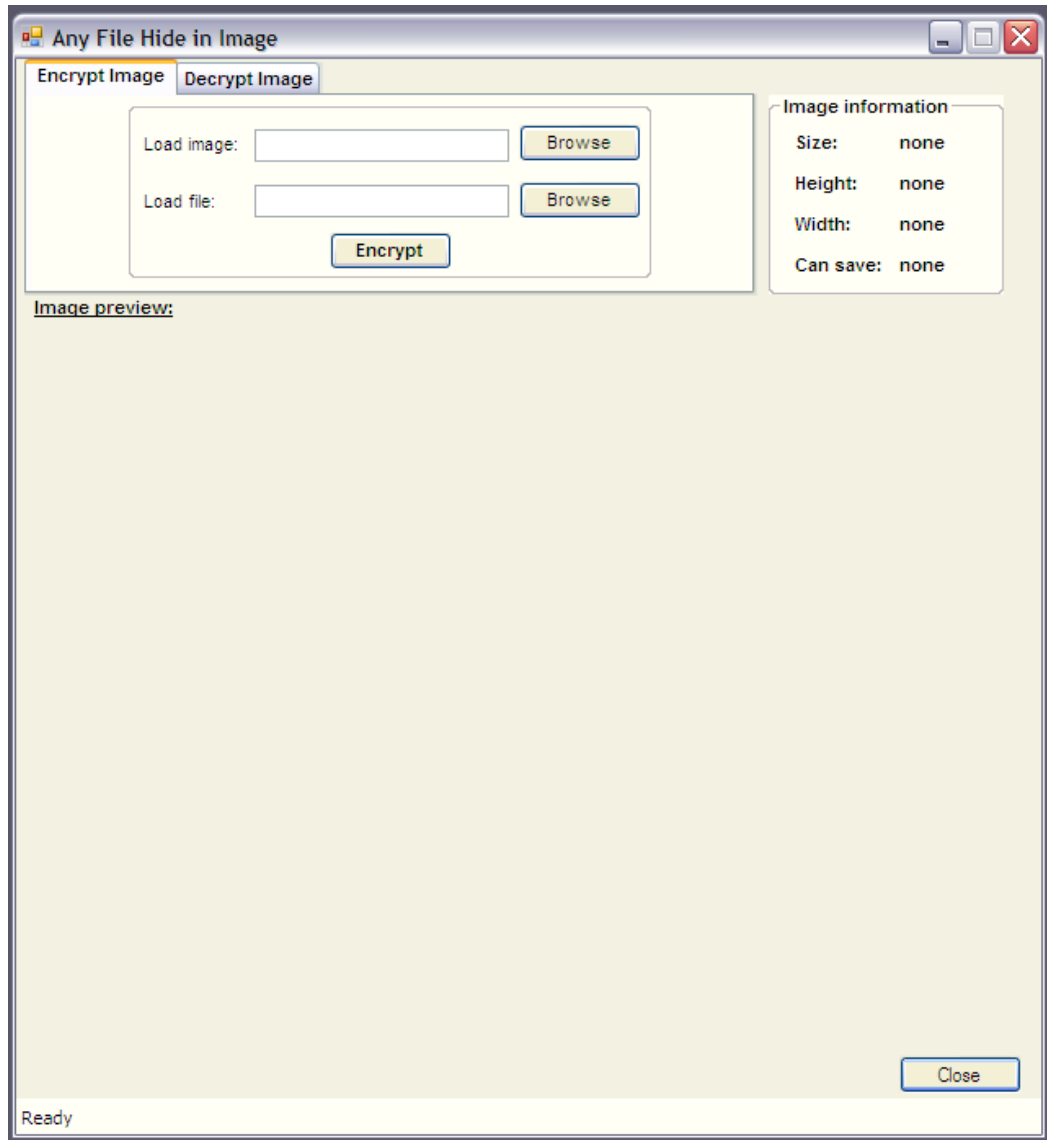

2. For load image click on button "Browse" that is next to the Load Image textbox. The file open dialog box will displays as follows, select the Image file, which you want to use hide information and click on Open button.

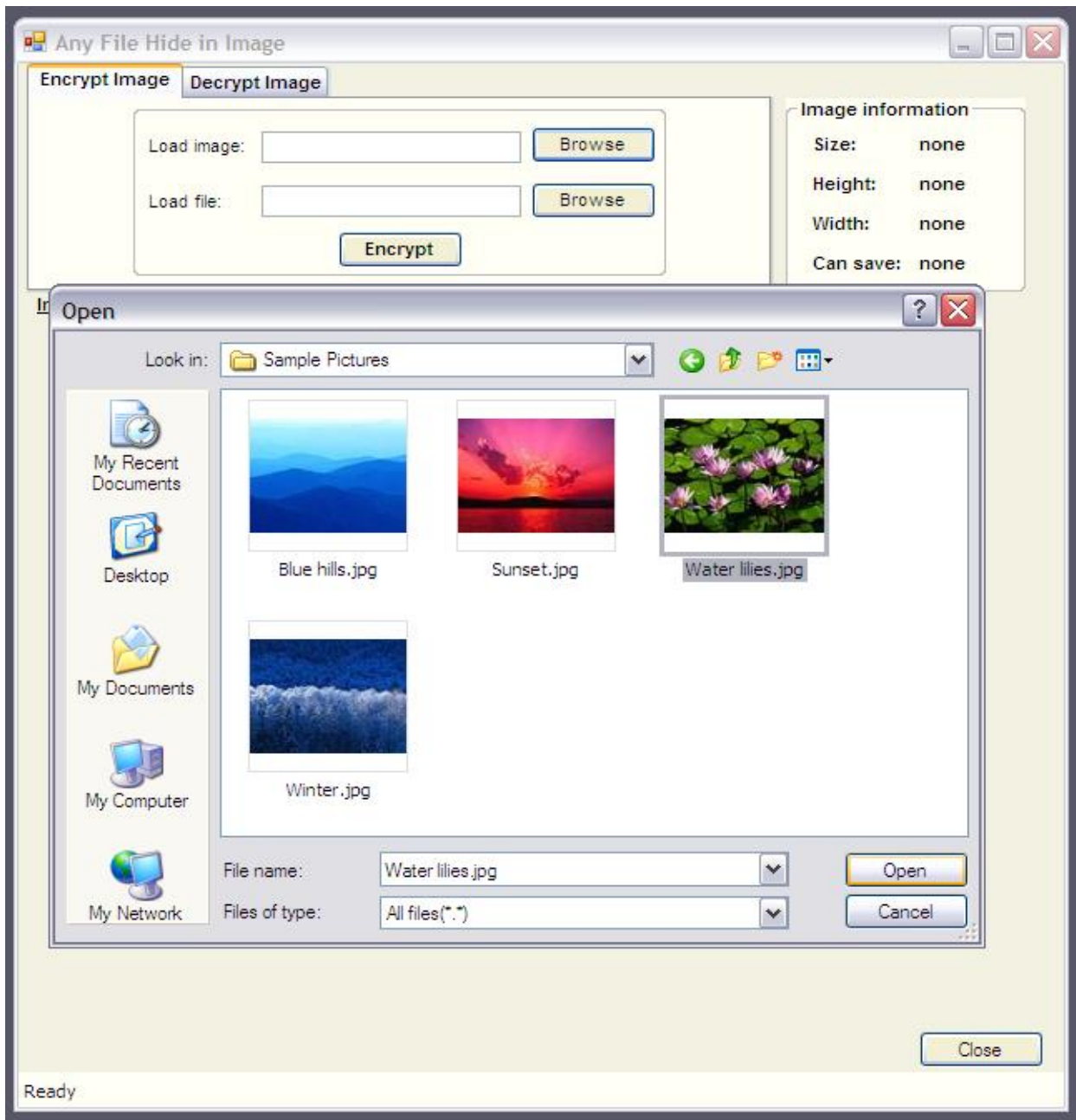

3. The image file will be opened and is displayed as follows. Next, click on "Browse" button that is next to the Load File textbox.

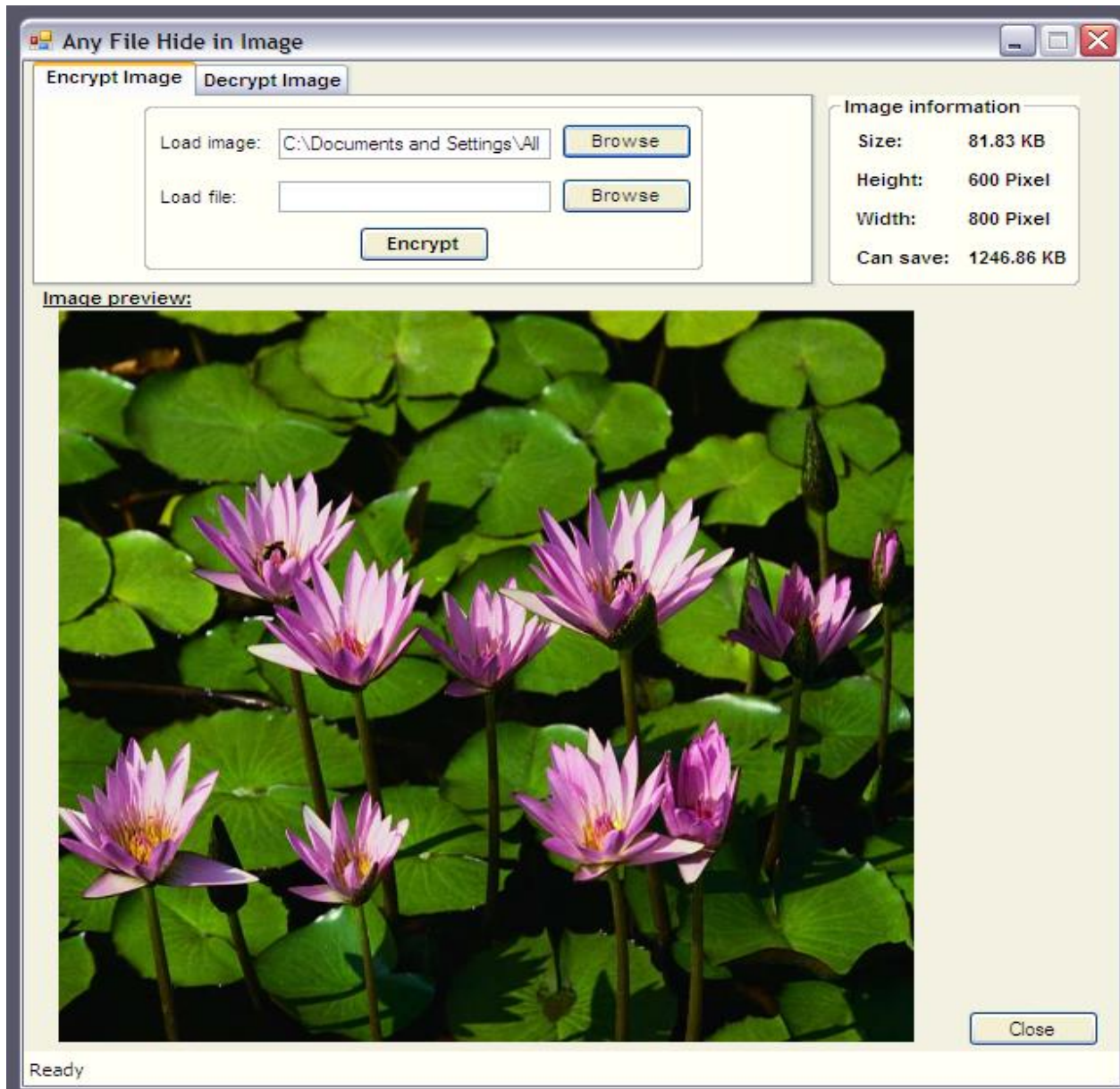

- Again the file open dialog box will appear, select any type of file whatever you want to hide with the image and click on ok button.

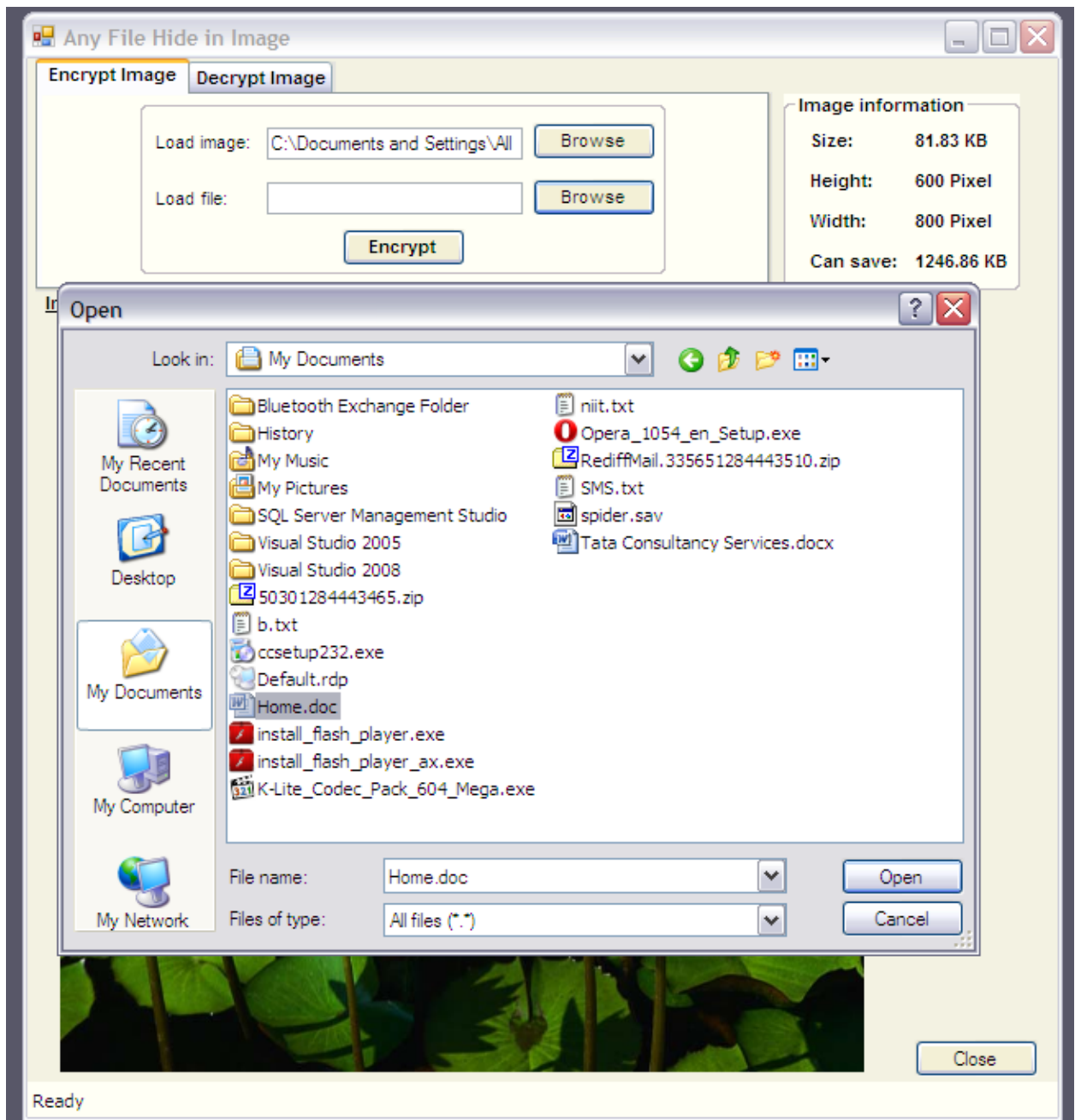

- The next step is to encrypt the file. Now click on "Encrypt" button, it will open the save dialog box which ask you to select the path to save the New image file and the Image file name. The default format of image file is BMP.

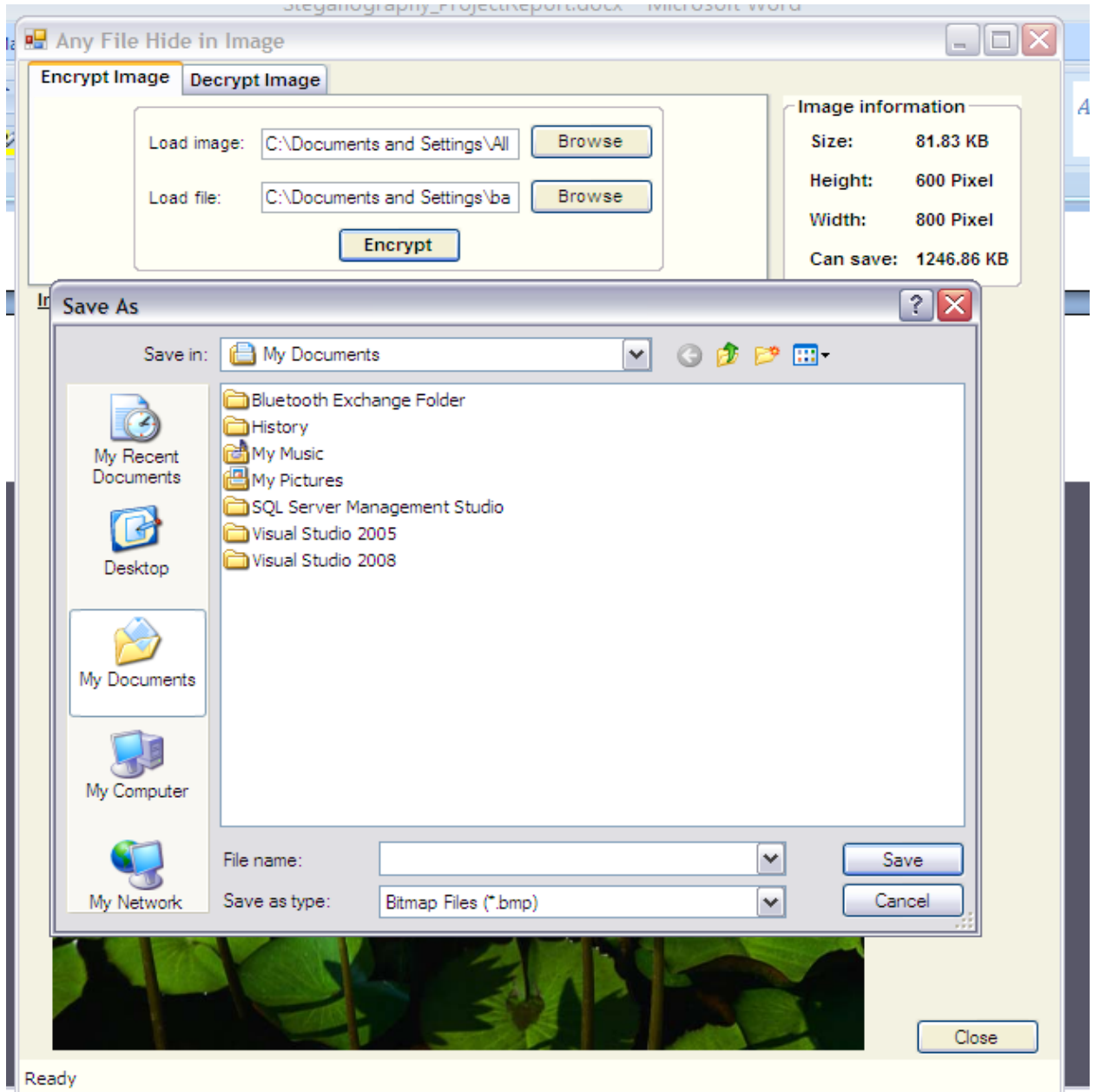

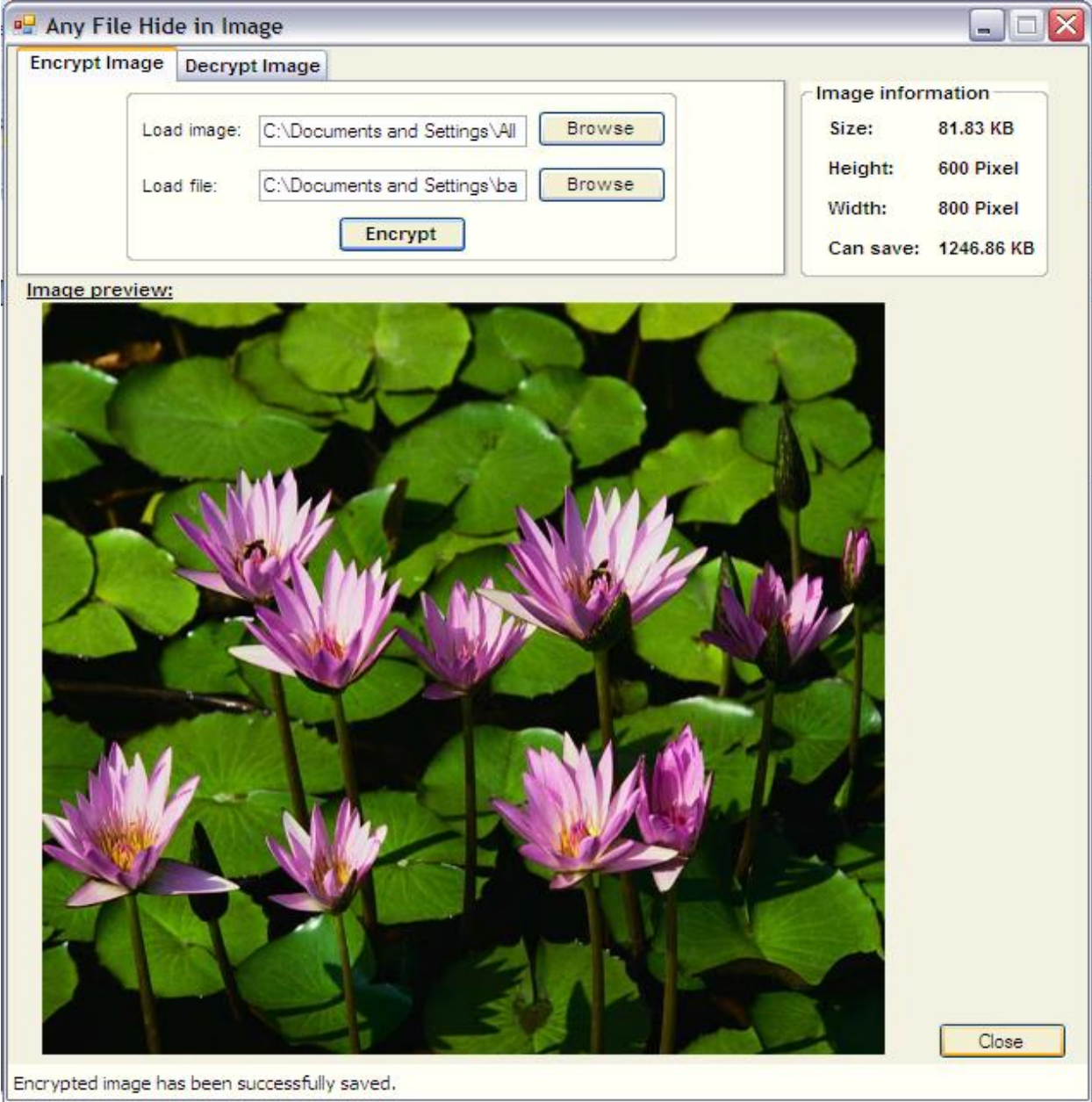

Decryption

1. Select the Decryption Image tab option.

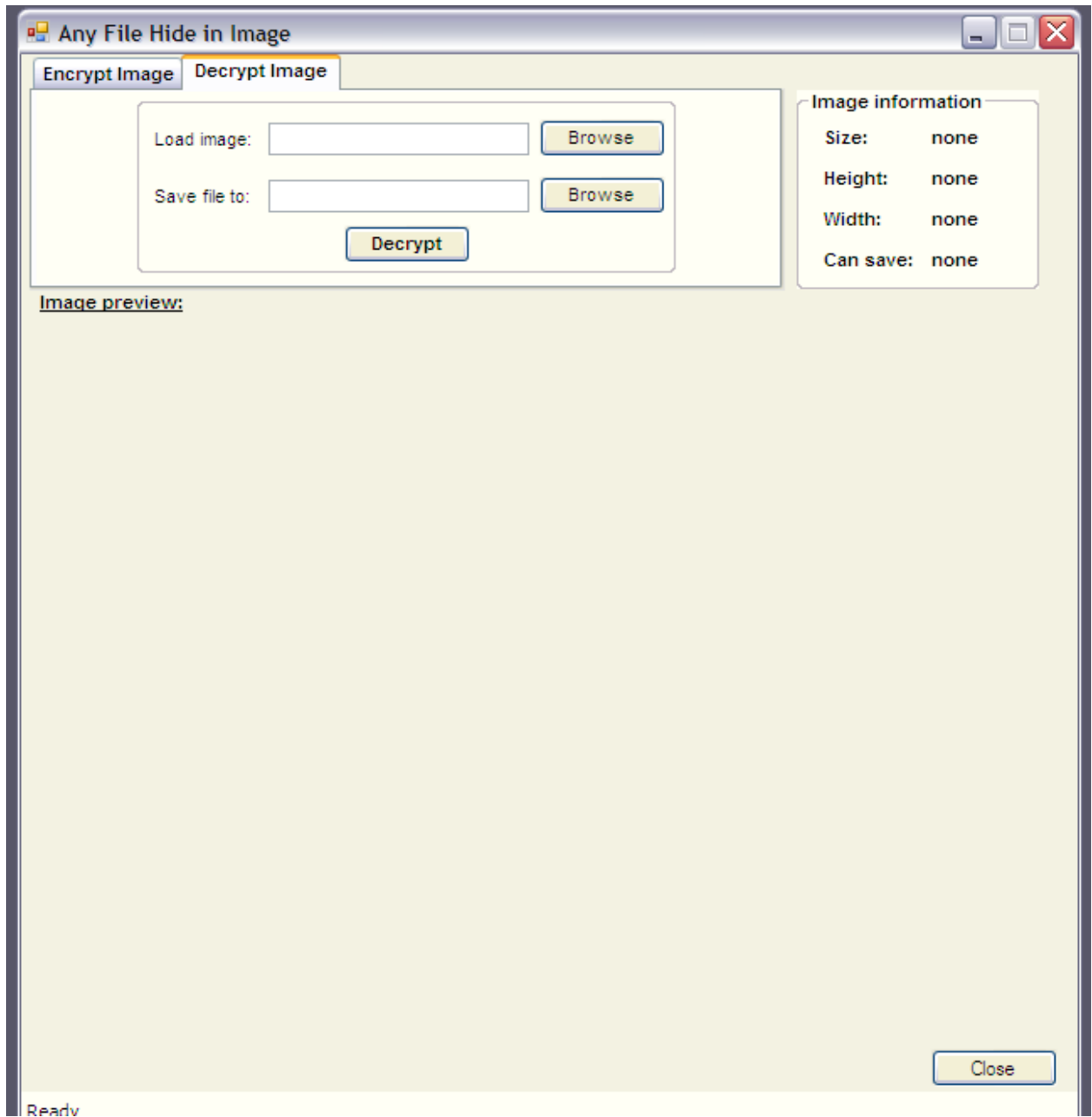

- Next click on the “Browse” button, which open the Open file dialog box, here you have to select the image which is Encrypted and has hidden information file. Select the image file and click on Open button.

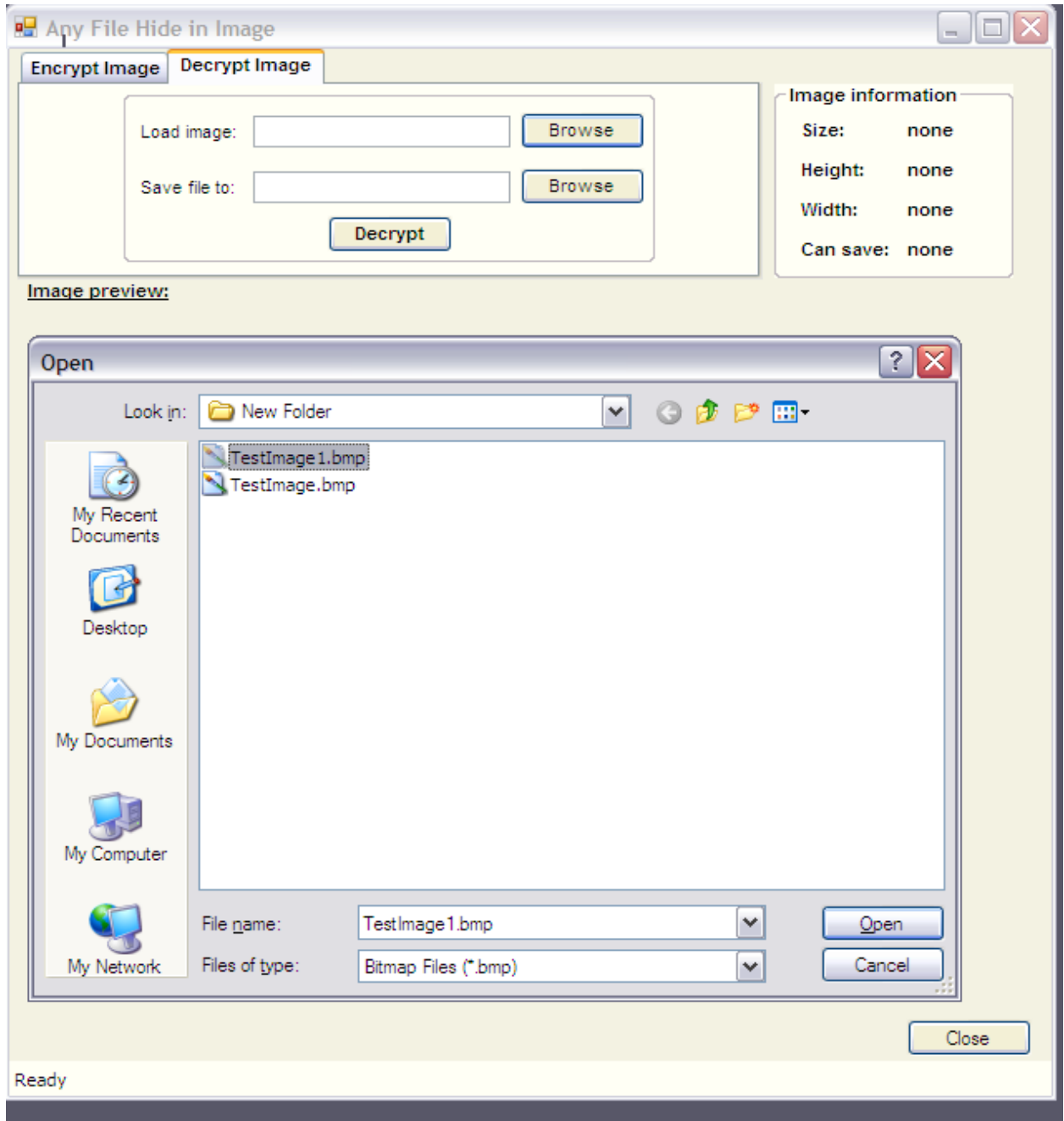

3. The image file displayed as follows:

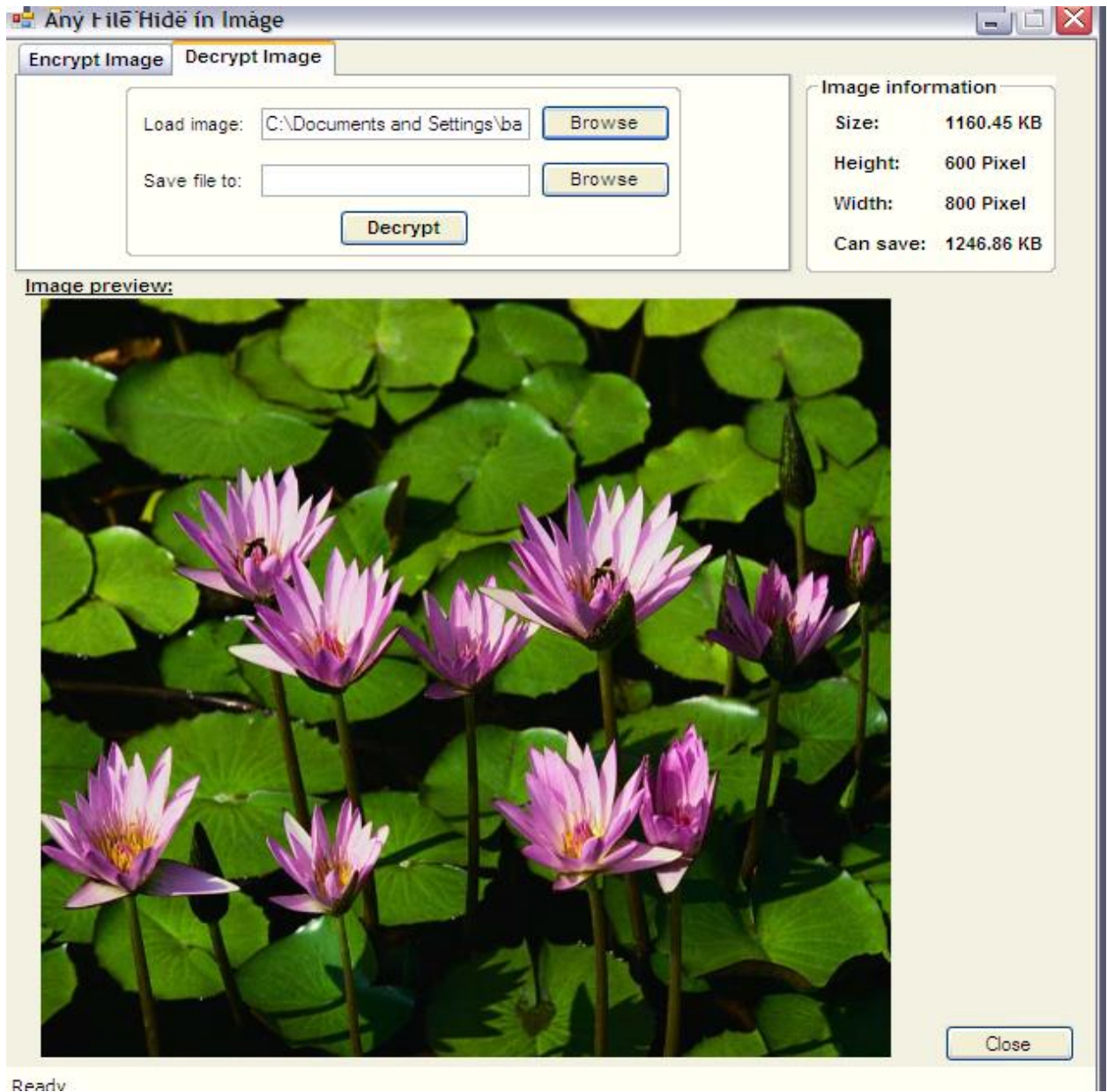

4. Now click on "Browse" button which is next to "Save file to" textbox. It will open a dialog box that is "Browse for folder". It ask you to select the path or folder, where you want to extract the hidden file. Select the folder and click on Ok button.

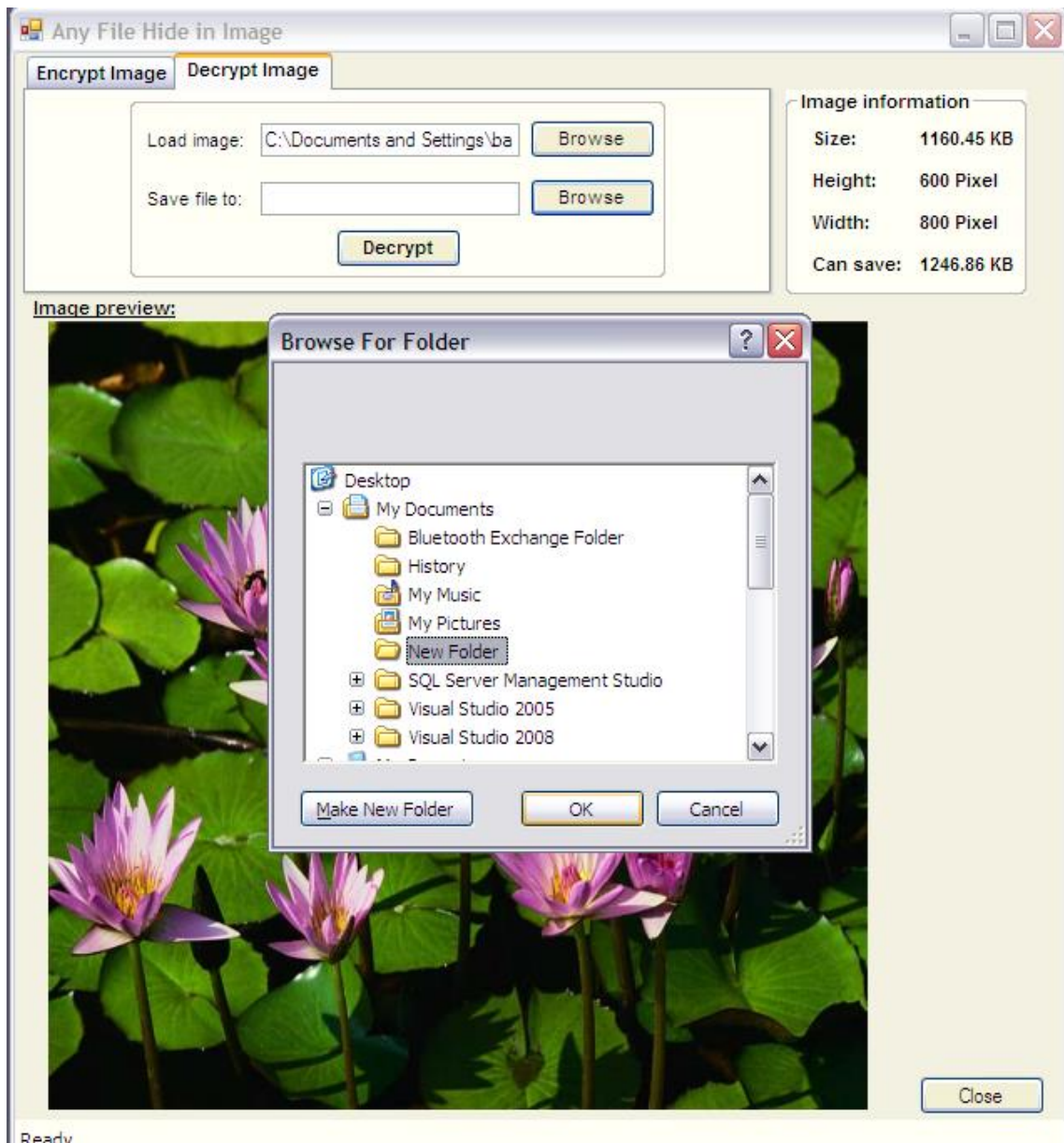

5. Now click on Decrypt button, it will decrypt the image, the hidden file and image file is saved into selected folder. The message for successful decryption is displayed on the status bar which is places at bottom of the screen.

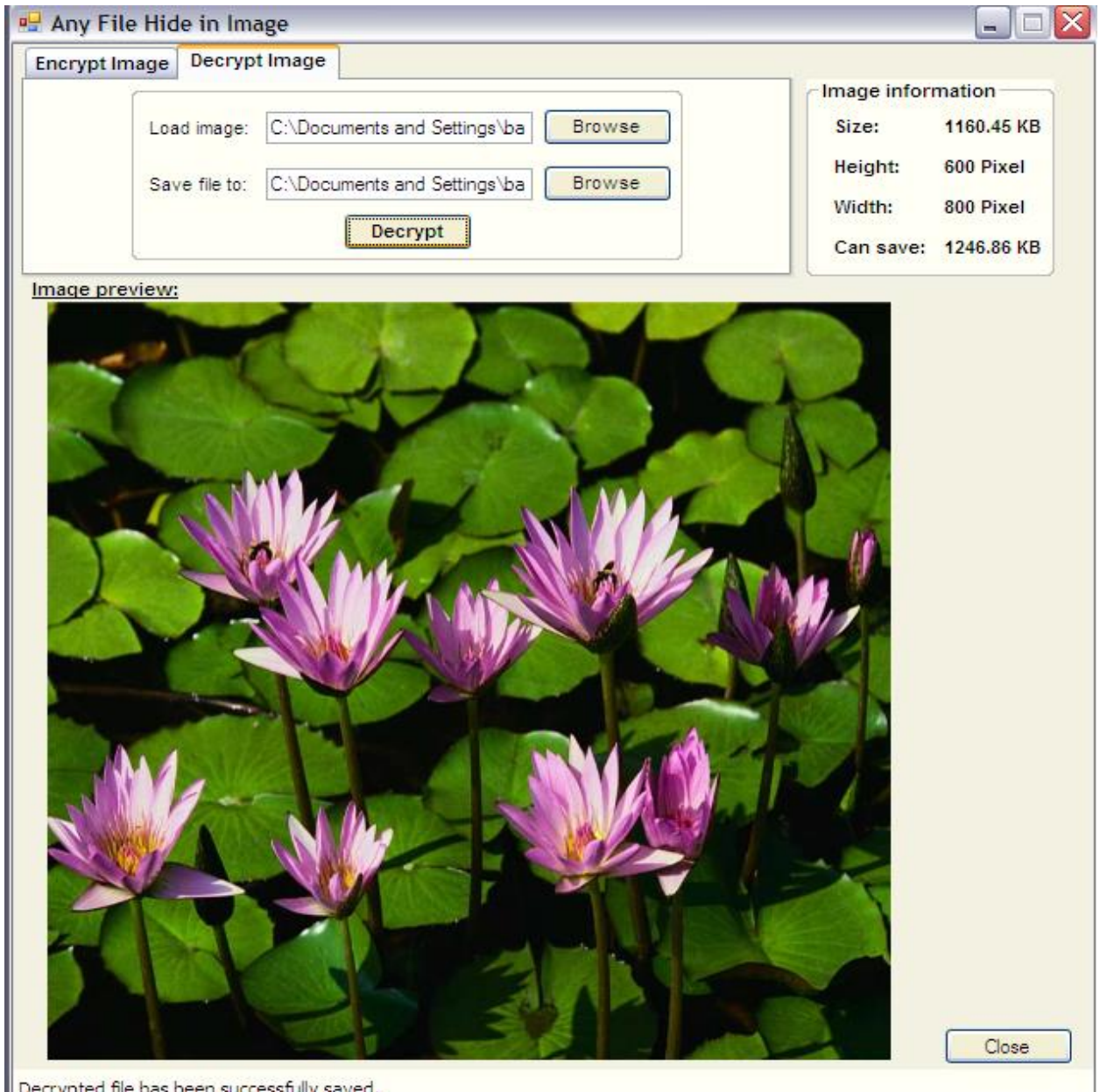

Summary

Steganography is a really interesting subject and outside of the mainstream cryptography and system administration that most of us deal with day after day.

Steganography can be used for hidden communication. We have explored the limits of steganography theory and practice. We printed out the enhancement of the image steganography system using LSB approach to provide a means of secure communication. A stego-key has been applied to the system during embedment of the message into the cover image.

This steganography application software provided for the purpose to how to use any type of image formats to hiding any type of files inside their. The master work of this application is in supporting any type of pictures without need to convert to bitmap, and lower limitation on file size to hide, because of using maximum memory space in pictures to hide the file.

Since ancient times, man has found a desire in the ability to communicate covertly. The recent explosion of research in watermarking to protect intellectual property is evidence that steganography is not just limited to military or espionage applications. Steganography, like cryptography, will play an increasing role in the future of secure communication in the “digital world”.

Bibliography

Websites

Following websites are referring to create this project reports.

- <http://www.google.com>
- <http://www.microsoft.com>
- <http://www.programmer2programmer.net>
- <http://www.codeproject.com>
- <http://www.asp.net>
- <http://www.asp123.com>
- <http://www.wikipedia.org>

Books

Following books and ebook are used to complete this project reports.

- Mastering C# (Paperback)
- SQL Server Bible (Paperback)
- .NET Black Book (Paperback)
- Professional C#, 2nd Edition (Paperback)
- Professional ASP.NET (Paperback)
- MCAD/MCSD Self-Paced Training Kit: Developing Web Applications with Microsoft® Visual Basic® .NET and Microsoft Visual C#® .NET, Second Edition
- MCAD/MCSE/MCDBA Self-Paced Training Kit: Microsoft SQL Server 2000 Database Design and Implementation, Exam 70-229, Second Edition