

EX LIBRIS

APPLIED ELECTROCHEMISTRY



THE MACMILLAN COMPANY
NEW YORK · BOSTON · CHICAGO
SAN FRANCISCO

MACMILLAN & CO., LIMITED
LONDON · BOMBAY · CALCUTTA
MELBOURNE

THE MACMILLAN CO. OF CANADA, LTD.
TORONTO

APPLIED ELECTROCHEMISTRY

BY

M. DE KAY THOMPSON, PH.D.

ASSISTANT PROFESSOR OF ELECTROCHEMISTRY IN THE
MASSACHUSETTS INSTITUTE OF TECHNOLOGY

LIBRARY OF
CALIFORNIA

New York

THE MACMILLAN COMPANY

1914

All rights reserved

TP 255
T47

COPYRIGHT, 1911,
By THE MACMILLAN COMPANY.

Set up and electrotyped. Published May, 1911. Reprinted
April, 1914.

TO VNU
ALBANY, N.Y.

Norwood Press
J. S. Cushing Co. — Berwick & Smith Co.
Norwood, Mass., U.S.A.

PREFACE

THE following book was written to supply a need felt by the author in giving a course of lectures on Applied Electrochemistry in the Massachusetts Institute of Technology. There has been no work in English covering this whole field, and students had either to rely on notes or refer to the sources from which this book is compiled. Neither of these methods of study is satisfactory, for notes cannot be well taken in a subject where illustrations are as important as they are here; and in going to the original sources too much time is required to sift out the essential part. It is believed that, by collecting in a single volume the material that would be comprised in a course aiming to give an account of the most important electrochemical industries, as well as the principal applications of electrochemistry in the laboratory, it will be possible to teach the subject much more satisfactorily.

The plan adopted in this book has been to discuss each subject from the theoretical and from the technical point of view separately. In the theoretical part a knowledge of theoretical chemistry is assumed.

Full references to the original sources have been made, so that every statement can be easily verified. It is thought that this will make this volume useful also as a reference book.

An appendix has been added, containing the more important constants that are needed in electrochemical calculations.

Thanks are due to the following individuals and companies for permission to reproduce cuts, or to use the material in the text, or for both: the American Academy of Arts and Sciences; the American Electrochemical Society; the Carborundum Company; Wilhelm Engelmann; Ferdinand Enke; the Electric Storage Battery Company; the *Engineering and Mining Journal*; the Faraday Society; the Franklin Insti-

tute; Charles Griffin and Company; Gould Storage Battery Company; Dr. Eugene Haanel; the Hanson and Van Winkle Company; Mr. Carl Hering; Mr. Walter E. Holland of Thomas A. Edison's Laboratory; International Acheson Graphite Company; Wilhelm Knapp; Longmans, Green and Company; Progressive Age Publishing Company; Dr. E. F. Roeber, Editor of the *Metallurgical and Chemical Engineering*; Julius Springer; Spon and Chamberlain; John Wiley and Sons.

TABLE OF CONTENTS

CHAPTER I

	PAGES
COULOMETERS OR VOLTAMETERS	1-12
1. General Discussion—2. The Silver Coulometer—3. The Copper Coulometer—4. The Water Coulometer—5. The Silver Titration Coulometer.	

CHAPTER II

ELECTROCHEMICAL ANALYSIS	13-29
1. Nonelectrolytic Methods—2. Electrolytic Methods.	

CHAPTER III

ELECTROPLATING, ELECTROTYPING, AND THE PRODUCTION OF METALLIC OBJECTS	30-42
1. Electroplating: <i>Nickel Plating; Copper Plating; Zinc Plating; Brass Plating; Silver Plating; Gold Plating</i> —2. Galvanoplasty: <i>Electrotyping; Copper Tubes, Foil, and Wire.</i>	

CHAPTER IV

ELECTROLYTIC WINNING AND REFINING OF METALS IN AQUEOUS SOLUTIONS	43-67
1. The Winning of Metals: <i>Copper and Zinc</i> —2. The Electrolytic Refining of Metals: <i>Copper Refining; Nickel Refining; Silver Refining; Gold Refining; Lead Refining; Zinc Refining.</i>	

CHAPTER V

ELECTROLYTIC REDUCTION AND OXIDATION	68-79
1. Reduction—2. Oxidation.	

CHAPTER VI

ELECTROLYSIS OF ALKALI CHLORIDES	80-136
1. Theoretical Discussion: <i>The Chemical Action of Chlorine on Water and Alkali Hydrate; The Electrolysis of Alkali Chloride on</i>	

Smooth Platinum Electrodes without a Diaphragm; The Electrolysis of Alkali Chlorides with Platinized Platinum Anodes; The Electrolysis of Alkali Chlorides on Carbon Anodes; The Maximum Concentrations of Hypochlorite and the Maximum Current and Energy Yields of Hypochlorite and Chlorate; The Production of Perchlorates; The Electrolysis of Alkali Chlorides with a Diaphragm; Decomposition Points and Potentials of Alkali Chloride Solutions; Fluorides, Bromides, and Iodides — 2. Technical Cells for Hypochlorite, Chlorate, Hydrate, and Chlorine.

CHAPTER VII

THE ELECTROLYSIS OF WATER 137-141

CHAPTER VIII

PRIMARY CELLS 142-151

CHAPTER IX

THE LEAD STORAGE BATTERY 152-172

1. History and Construction — 2. Theory of the Lead Storage Battery.

CHAPTER X

THE EDISON STORAGE BATTERY 173-184

1. General Discussion — 2. Theory of the Edison Storage Battery.

CHAPTER XI

THE ELECTRIC FURNACE 185-201

1. General Discussion — 2. Electric Furnace Design.

CHAPTER XII

PRODUCTS OF THE RESISTANCE AND ARC FURNACE 202-238

1. Calcium Carbide — 2. Carborundum — 3. Siloxicon — 4. Silicon — 5. Graphite — 6. Carbon Bisulphide — 7. Phosphorus — 8. Alundum — 9. Aluminum — 10. Sodium and Potassium — 11. Calcium.

CHAPTER XIII

	PAGES
THE ELECTROMETALLURGY OF IRON AND STEEL	239-264
1. General Discussion—2. The Electrothermic Reduction of Iron Ores—3. The Electrothermic Refining of Steel.	

CHAPTER XIV

THE FIXATION OF ATMOSPHERIC NITROGEN	265-287
1. Introduction—2. Absorption by Calcium Carbide—3. The Oxidation of Nitrogen—4. The Synthesis of Ammonia—5. Con- clusion.	

CHAPTER XV

THE PRODUCTION OF OZONE	288-314
1. General Discussion: <i>The Maximum Concentration; Yield per Coulomb for Negative Point Electrode; Yield per Coulomb for Posi- tive Point Electrode; Yield per Kilowatt Hour for Positive and for Negative Points; Theory of Ozone Formation by Silent Discharge; The Siemens Ozonizer</i> —2. The Technical Production of Ozone.	

APPENDIX	315-321
Atomic Weights—Electrochemical Equivalents—Numerical Relation between Various Units—Legal Electrical Units.	

NAME INDEX	323-325
SUBJECT INDEX	327-329

LIST OF ABBREVIATIONS

Ann. d. Phys.	Annalen der Physik.
Ann. d. Chem. und Pharm.	Annalen der Chemie und Pharmacie.
Ann. d. Chim. et de Physique	Annales de Chimie et de Physique.
B. B.	Berichte der Deutschen Chemischen Gesellschaft.
Berg- und Hüttenm. Ztg.	Berg- und Hüttenmännische Zeitung.
Chem. News.	Chemical News.
Chem. Zeitung.	Chemiker Zeitung.
C. R.	Comptes Rendus des Séances de l'Académie des Sciences.
Dingler's polyt. J.	Dingler's Polytechnisches Journal.
Electrochem. and Met. Ind.	Electrochemical and Metallurgical Industry.
Electroch. Ind.	Electrochemical Industry.
Elektrotech. Z.	Elektrotechnische Zeitschrift.
El. World.	Electrical World.
Eng. and Min. J.	Engineering and Mining Journal.
Gilbert's Ann.	Gilbert's Annalen.
J. f. prakt. Ch.	Journal für praktische Chemie.
Journ. of the Franklin Inst.	Journal of the Franklin Institute.
J. Am. Chem. Soc.	Journal of the American Chemical Society.
Met. and Chem. Eng.	Metallurgical and Chemical Engineering.
Min. Ind.	Mineral Industry.
Phil. Mag.	Philosophical Magazine.
Phil. Trans.	Philosophical Transactions.
Phys. Rev.	Physical Review.
Pogg. Ann.	Poggendorff's Annalen.
Proc. Am. Acad.	Proceedings of the American Academy of Arts and Sciences.
Proc. Am. Phil. Soc.	Proceedings American Philosophical Society.
Proc. Royal Soc. of Edinburgh	Proceedings of the Royal Society of Edinburgh.
Proc. Soc. Arts.	Proceedings of the Society of Arts, Boston.
Trans. Am. Electrochem. Soc.	Transactions of American Electrochemical Society.
Z. f. anal. Ch.	Zeitschrift für analytische Chemie.

- Z. f. angew. Ch. Zeitschrift für angewandte Chemie.
Z. f. anorg. Ch. Zeitschrift für anorganische Chemie.
Z. f. Berg-, Hüttenm.- und Salinen-Wesen. Zeitschrift für das Berg-, Hüt-
tenmännische- und Salinen-Wesen in
preussische Staaten.
Z. f. Elektroch. Zeitschrift für Elektrochemie.
Z. f. phys. Ch. Zeitschrift für physikalische Chemie.

APPLIED ELECTROCHEMISTRY

APPLIED ELECTROCHEMISTRY

CHAPTER I

COULOMETERS¹ OR VOLTAMETERS

1. GENERAL DISCUSSION

AN important application of electrolysis is the determination of the amount of electricity passing through a circuit in a given time. According to Faraday's laws, (1) the magnitude of the chemical effects produced in a circuit is proportional to the quantity of electricity that passes through the circuit, and (2) the quantities of the different substances which separate at electrodes throughout the circuit are directly proportional to their equivalent weights.² The first statement is true under all conditions, but the second only for the case that a single substance is liberated on any given electrode. If several substances are deposited together on the same electrode, there is, of course, less of each than if only one is deposited.

The electrochemical constant, or the quantity of electricity necessary to deposit one equivalent weight of any substance, has been accurately determined by measuring the amount of silver deposited for a known quantity of electricity. The value of this constant generally accepted is 96,540 coulombs, and is accurate to a few hundredths of a per cent.³

¹ This name was proposed by T. W. Richards, Proc. Am. Acad. **37**, 415, (1902).

² Le Blanc, Electrochemistry, English translation, p. 42, (1907).

³ Nernst, Theoretische Chemie, 6th ed., p. 715, (1909); Guthe, Bulletin of the Bureau of Standards, **1**, 362, (1905).

It is evident from the above that the amount of electricity passing through a circuit can be determined from the amount of chemical change produced at any electrode if this chemical change can be measured. There are three general methods of making this measurement: (1) by weighing the substance deposited or liberated, (2) by measuring its volume, and (3) by titration. It seems hardly necessary to call attention to the fact that in any coulometer the current can be computed from the quantity of electricity that has passed through the circuit, if the current has been constant and if the time is measured. Current in amperes equals quantity in coulombs divided by time in seconds.

The errors of coulometers are those inherent in the measurement of weight and volume or in titration, and also those due to imperfections in the coulometer itself. The latter may come from a variety of causes, such as the liberation of other substances than the one assumed, or the loss of the substance after deposition and before weighing. The errors of each coulometer described below will be pointed out.

2. THE SILVER COULOMETER

The silver coulometer is the most accurate of all electrochemical coulometers. It is for this reason that it is used to determine the electrochemical constant. It consists of a platinum dish cathode, a neutral silver nitrate solution made by dissolving 20 to 40 grams of nitrate in 100 grams of distilled water, and a pure silver anode. By weighing the platinum dish before and after the current has passed, the amount of electricity may be computed from the value of the electrochemical equivalent of silver given above. To obtain the best results, the anode should be wrapped in filter paper,¹ in order to prevent any silver mechanically detached from the anode from falling into the platinum dish, or contained in a porous cup, which also separates the anode solution from the cathode. The solution from the anode would deposit too much silver on the

¹ Richards, Collins, and Heimrod, Proc. Am. Acad. **35**, 143, (1899).

has been found that a coulometer using this liquid, on excluding oxygen, gives accurate results without the danger of detaching any silver in weighing.⁴

3. THE COPPER COULOMETER

The copper coulometer consists usually of two sheets of copper for anodes, with a thin copper sheet hung between them as cathode, in an acid solution of copper sulphate. It is not so accurate as the silver coulometer for several reasons. In the first place, only 0.29 gram copper is deposited to every gram of silver. This reduces the percentage accuracy of the weight to about one third of the value it would have for an equivalent amount of silver. More important than this are the chemical reactions that tend to change the weight of copper deposited on the cathode from the correct weight. The copper cathode dissolves slightly in acid cupric sulphate, forming cuprous sulphate:

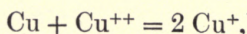

thereby reducing the weight of the cathode. This takes place to a less extent if oxygen is excluded. On the other hand, in a neutral solution the plate gains in weight, due to a covering of cuprous oxide coming from hydrolysis of the cuprous sulphate. With increasing temperature not only does the velocity of the above reaction increase, but also the amount of cuprous ions in equilibrium with cupric ions, and consequently more cuprous ions are deposited. Wherever cuprous ions are deposited, the weight of copper is too great, as the electrochemical equivalent of cuprous copper is double that of cupric.

The solution generally used in the copper coulometer is that recommended by Oettel,¹ consisting of 1000 grams of water, 150 grams of crystallized copper sulphate, 50 grams of concen-

⁴ Farup, *Z. f. Elektroch.* **8**, 569, (1902).

¹ *Chem. Zeitung*, **17**, 543, and 577.

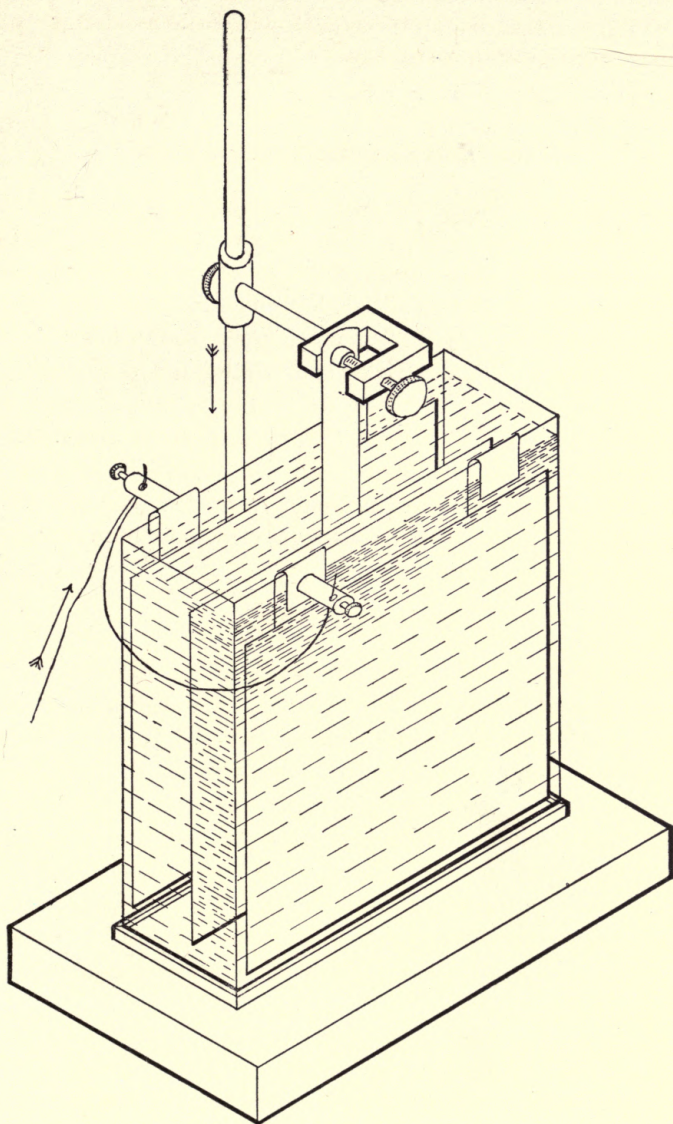

FIG. 2. — Copper coulometer

trated sulphuric acid, and 50 grams of alcohol. The alcohol drives back the dissociation of the cupric sulphate, reducing the concentration of the cupric ions and therefore of the cuprous ions in equilibrium with them.² For ordinary purposes the exclusion of air is not necessary. The current density on the cathode should lie between 2 and 20 milliamperes per square centimeter. The advantages of the copper over the silver coulometer are its greater cheapness and the greater adhesiveness of the deposit on the cathode. The average error of a single determination is from 0.1 to 0.3 per cent.³ A convenient form of the copper coulometer is shown in Figure 2. The inside dimensions of the glass vessel are approximately 4.3 centimeters in width, 16 centimeters in height, and 17 centimeters in length.

4. THE WATER COULOMETER

The water coulometer measures the quantity of electricity passing through a circuit by the amount of water decomposed between unattackable electrodes dipping in a solution through which the current flows. The amount of water decomposed may be determined by measuring the loss in weight of the coulometer, by measuring the total volume of gas produced, or by measuring the volume of either one of the gases separately.

The decomposition of water by the electric current was first observed by Nicholson and Carlisle¹ in 1800. In 1854 Bunsen² used a water coulometer in which the loss in weight was determined; and since then others have devised coulometers on the same principle.³ Figure 3 shows a convenient form of the apparatus, having a drying tube sealed directly to it; for before leaving the cell the gases must, of course, be thoroughly

² Foerster and Seidel, *Z. f. anorg. Ch.* **14**, 135, (1897).

³ Ostwald-Luther, *Hand- und Hilfsbuch*, 3d ed. 497, (1910).

¹ Gilbert's *Ann.* **6**, 340, (1800).

² Pogg. *Ann.* **91**, 620, (1854).

³ L. N. Ledingham, *Chem. News*, **49**, 85, (1884).

dried so that no water vapor is carried off with them. It is evident that this instrument cannot give great accuracy on account of the relatively small change in weight produced by the passage of an amount of electricity equal to the electrochemical constant. In the case of water the change in weight is only 9 grams, as compared with 31.2 grams of copper and 107.9 grams of silver. The errors inherent in the instrument itself are due to the formation of other products than hydrogen and oxygen. If a solution of sulphuric acid is used between platinum electrodes, the oxygen liberated on the anode contains a certain amount of ozone.⁴ Persulphuric acid, $H_2S_2O_8$, and hydrogen peroxide, due to the oxidation of water by the persulphuric acid, are also produced. The production of persulphuric acid is a maximum when the concentration of the solution is between 30 and 50 grams of sulphuric acid to 100 grams of water.⁵ For this reason a 10 to 20 per cent solution of sodium hydrate is often used, in which none of the above disturbing reactions occur.

The presence of even a small amount of salt of a metal with two different valences, such as iron, may cause a very large error. Table 1 shows what the magnitude of this error is for iron impurities.⁶

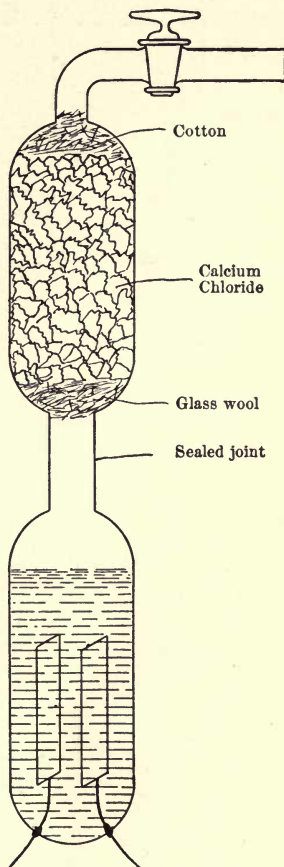

FIG. 3.— Water coulometer

⁴ Schönbein, Pogg. Ann. **50**, 616, (1840).

⁵ Franz Richarz, Ann. d. Phys. **24**, 183, (1855); **31**, 912, (1887).

⁶ Elbs, Z. f. Elektroch. **7**, 261 (1900).

TABLE 1

IRON CONTENT IN PER CENT	CURRENT DENSITY PER SQUARE DM.	LOSS IN DETONATING GAS IN PER CENT
1.0	2.23	48.3
1.0	0.228	97.4
0.1	6.4	3.0
0.1	0.35	25.1
0.01	2.22	1.7
	0.360	6.3

It is to be noticed that this error is diminished by increasing the current density.

Sulphuric acid of 1.14 specific gravity has been shown by

F. Kohlrausch⁷ to give results as accurate as the measurements themselves in coulometers where the total volume of gas is measured. He simultaneously devised a form of coulometer shown in Figure 4. The glass tube is 4 centimeters in diameter and is divided into units of 5 cubic centimeters. The base contains 500 cubic centimeters. The anode is platinum foil, 4 centimeters long and 1.7 centimeters wide, placed between two cathodes of the same size. To refill the tube it is simply turned upside down. A thermometer is sealed in for determining the temperature of the gas. On account of the limited volume of this apparatus, large quantities of elec-

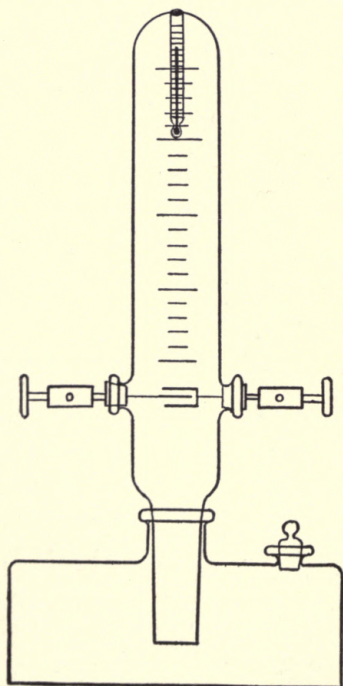

FIG. 4. — Kohlrausch water coulometer

⁷ Elektrotech. Z. 6, 190, (1885).

tricity cannot be measured; it is intended for the measurement of currents between 3 and 30 amperes. The relation between the volume of gas generated in one second, saturated with water vapor at the vapor pressure corresponding to a sulphuric acid solution of specific gravity 1.14, and the current is as follows: For 20° and a pressure of 72.5 centimeters of mercury, one ampere in one second produces 0.2 cubic centimeter of gas, including the water vapor. Therefore, under these conditions of temperature and pressure, the number of cubic centimeters of gas generated per second, when multiplied by 5, gives the current in amperes. The corrections for the volume in thousandths of a cubic centimeter for different temperatures and pressure are given in Table 2.

TABLE 2

Corrections, in Thousandths of a Cubic Centimeter, for Reducing the Volume of Gas generated in One Second to the Value which, multiplied by 5, gives the Current. Specific Gravity of Sulphuric Acid : 1.14

TEMP. CENTIGRADE DEGREES	700 mm.	710 mm.	720 mm.	730 mm.	740 mm.	750 mm.	760 mm.
10	9	24	38	53	68	82	97
11	5	19	33	48	63	78	93
12	1	15	29	44	59	73	88
13	-4	10	24	39	54	69	83
14	-8	6	20	35	49	64	78
15	-13	2	16	30	44	59	73
16	-17	-3	11	26	40	54	68
17	-22	-7	7	21	35	49	63
18	-26	-12	2	16	30	45	59
19	-31	-17	-3	11	26	40	54
20	-35	-21	-7	7	21	35	49
21	-40	-26	-12	2	16	30	44
22	-44	-30	-17	-3	11	25	39
23	-49	-35	-22	-8	6	20	34
24	-54	-40	-26	-12	1	15	29
25	-58	-45	-31	-17	-4	10	24

The following example will illustrate the use of this table.

Barometer, 0°	754 millimeters of mercury.
Height of sulphuric acid in tube	112 millimeters of mercury.
Pressure in gas = $754 - \frac{112}{1.2} = 745$.	
Temperature of gas: 17.°8.	
Volume of gas	198.0 cubic centimeters.
Correction: $+ 0.038 \times 198.0 =$	$\frac{7.5}{205.5}$ cubic centimeters.
	205.5 cubic centimeters.

Duration of experiment: 39 seconds.

Therefore in one second 5.27 c.c. of gas were generated.

Current = $5.27 \times 5 = 26.3$ amperes.

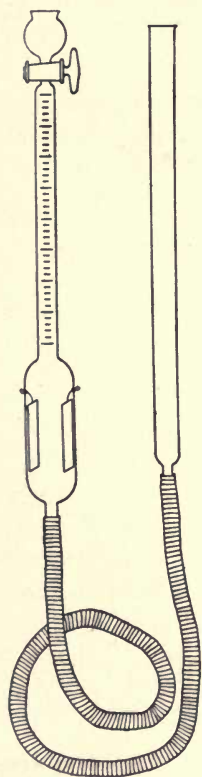

FIG. 5. — Water coulometer

On comparison with a tangent galvanometer the current indicated by this coulometer was found on an average to be $\frac{1}{7}$ per cent low.

In order to avoid correction for the height of the solution, the instrument may be made like a Hempel gas analysis burette, as shown in Figure 5.

A very convenient form of water coulometer has been devised by F. C. G. Müller,⁸ shown in Figure 6. The whole apparatus is placed in a water bath, so that the temperature of the gas can be determined. *A* is the electrolytic cell filled with barium hydrate, which does not foam like sodium or potassium hydrate. *F* is the gas receiver. The three-way

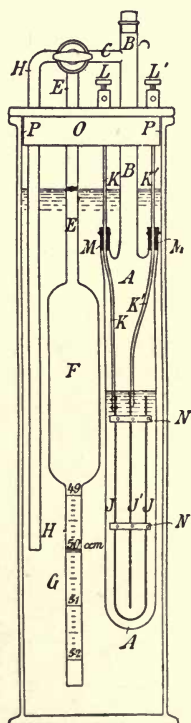

FIG. 6. — Müller's water coulometer

⁸ Z. f. d. phys. und chem. Unterricht, 14, 140, (1901).

stopcock at the top allows the gas to escape through H when no measurement is to be made. By turning the stopcock at a given second, the gas passes into H , which is previously filled with water to the upper mark. When H is filled with gas, the stopcock is turned to allow the gas to pass out H and the time noted. This apparatus can thus be left connected in the circuit and a measurement made at any time.

The water coulometer may be transformed into a direct reading ammeter by a method first applied in 1868 by F. Guthrie.⁹ If the gas is allowed to escape through a small hole, a definite pressure in the instrument is developed, depending on the current and size of the hole. The pressure is measured by a mercury or water manometer. This same principle has been rediscovered by J. Joly,¹⁰ Bredig and Hahn,¹¹ and Job.¹² In Bredig and Hahn's apparatus the gas escapes through capillary tubes, and by using a tube with different bores the range of the instrument is varied. Their apparatus is accurate to about 5 per cent.

5. THE SILVER TITRATION COULOMETER

The silver titration coulometer of Kistiakowsky¹ is sometimes convenient where the current does not exceed 0.2 ampere and where the duration of the experiment does not exceed an hour. A silver anode is dissolved in a 10 per cent potassium nitrate solution by the passage of the current, and is then titrated. In the improved form the silver anode is at the bottom of a tube 18 to 22 centimeters long, 3.5 centimeters in diameter at the top, and 1 centimeter at the bottom. The cathode is of copper and dips in a 7 per cent copper nitrate solution to which $\frac{1}{5}$ of its volume of a 10 per cent potassium

⁹ Phil. Mag. **35**, 334, (1868).

¹⁰ Proc. Royal Dublin Soc. **7**, 559, (1892).

¹¹ Z. f. Elektroch. **7**, 259, (1901).

¹² Z. f. Elektroch. **7**, 421, (1901).

¹ Z. f. Elektroch. **12**, 713, (1906).

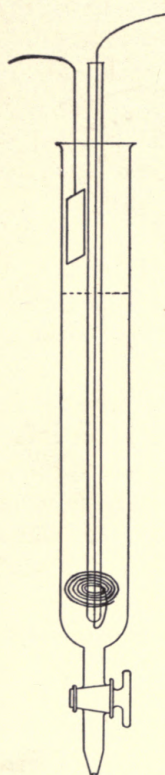

FIG. 7.—The Kistiakowsky titration coulometer

nitrate solution has been added. This solution is contained in a porous cup at the top of the tube. After the experiment the potassium nitrate solution containing the dissolved silver is drawn off and titrated with 0.02 normal potassium thiosulphate, and a saturated iron alum solution as indicator. The error of a single determination may amount to 0.5 per cent.

In the original form, which is the one still generally used, the cathode is of platinum and dips into a $\frac{1}{2}$ to $\frac{1}{4}$ normal solution of nitric acid. The division between the acid and the nitrate is shown in Figure 7 by the dotted line. In order to have the silver dissolve with 100 per cent efficiency, it should be freshly deposited electrolytically;² also, all of the anode should be the same distance from the cathode, as shown in the figure; otherwise the current density will be too great on the part nearest the cathode, and bubbles of gas may be given off. It is convenient to have the anode made of a platinum spiral of the form shown, on which a little more silver is deposited electrolytically before a measurement than will be dissolved off in the measurement.

² Ostwald-Luther, Hand- und Hilfsbuch, 3d ed. p. 500, (1910).

CHAPTER II

ELECTROCHEMICAL ANALYSIS.

1. NONELECTROLYTIC METHODS

THERE are four different electrical methods of quantitative analysis. These are (1) potential measurements, which give a means of determining the concentrations of ions too dilute to determine gravimetrically; (2) conductivity measurements, which is a method very convenient for determining concentrations of solutions; (3) titration with a galvanometer in place of an ordinary indicator, and finally (4) the ordinary electroanalysis, in which the metal is deposited on a platinum electrode and weighed.

The principle of the first method, originally pointed out by Ostwald,¹ is as follows: Suppose the concentration of silver chloride in its saturated solution is desired. If the electromotive force of the cell

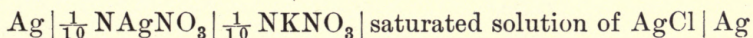

were measured, and the concentration c_1 of the silver ions in the nitrate were known, as it is from conductivity measurements, the concentration c_2 of the silver chloride ions could be computed by the Nernst formula

$$e = RT \log \frac{c_1}{c_2}.$$

In practice some conducting salt is added to the silver chloride solution in order to lower the resistance of the cell. If potas-

¹ Lehrbuch, 2d ed. II, 879.

sium chloride is chosen, the solubility of silver chloride is reduced, but its value in pure water can be computed from this result.² If potassium nitrate were used, no reduction in the solubility would take place. Where the concentration of the salt is so small, the ion concentration is very nearly equal to the total concentration on account of the fact that the salt is nearly 100 per cent dissociated. Other instances where this method of measuring ion concentrations has been found useful are in the determination of the solubility of mercurous chloride from the electromotive force of the cell :

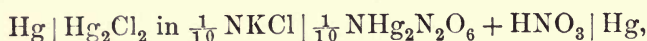

and from this result the solubility of mercurous sulphate from the electromotive force of the cell,³

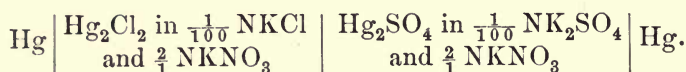

These examples are sufficient to illustrate the method. Some of the errors that attend these measurements may now be mentioned. One difficulty is to get different electrodes of the same metal to show exactly the same electromotive force when placed in the same solution of one of their salts. This seems to depend on the surface of the metal, and some method has to be used to make them as nearly identical as possible. This can often be accomplished by using an electrode covered electrolytically with a layer of the metal, or if the metal is more electro-positive than mercury, amalgams of equal concentrations may be used.⁴ The electrolytic solution pressure is thereby somewhat changed, but by the same amount for each electrode, and since the electrolytic solution pressure drops out, the resulting electromotive force is unaffected. Another method of obtaining constant results is to use the metal in a finely divided form. This may be done by depositing electrolytically with a high-current density or by decomposing some compound of the metal

² Goodwin, *Z. f. phys. Ch.* **13**, 641, (1894).

³ Wilsmore, *Z. f. phys. Ch.* **35**, 20, (1900).

⁴ Goodwin, *l.c.* p. 576.

in question.⁵ Another source of error is the potential at the junction of the different solutions, but this can generally be either calculated or reduced to an insignificant amount by adding some indifferent salt⁶ or by connecting the liquids with saturated solutions of potassium chloride⁷ or ammonium nitrate.⁸

A method based on potential measurement has been worked out for determining the amount of carbonic acid in gases.⁹ The gas bubbles through a solution of bicarbonate, and the resulting hydrogen ion concentration of the solution is determined by potential measurements, from which the partial pressure of the carbonic acid can be computed.

The principle involved in determining the amount of substance in a solution by conductivity measurement¹⁰ is the same as when any other physical property, such as specific gravity, is used for the purpose; that is, the relation between the conductivity and quantity of substance in solution must be known. These data have already been obtained in a large number of cases and have been collected by Kohlrausch and Holborn. If the solution contains a single electrolyte whose conductivity at given concentrations has already been determined, all that is necessary is to interpolate graphically or arithmetically in the table. If, however, there is a maximum conductivity, as in the case of sulphuric acid, there would be two possible concentrations for a given value of the conductivity. It is easy to tell on which side of the maximum such a solution lies by diluting a little and redetermining the conductivity. If the solution were more dilute than corresponds to the maximum value, further dilution would decrease the conductivity; if less dilute, the conductivity would be increased. In case the solution has a concentration near that of maximum conductivity,

⁵ Richards and Lewis, *Z. f. phys. Ch.* **28**, 1, (1899); also Lewis, *J. Am. Chem. Soc.* **28**, 158, (1905).

⁶ Bugarszky, *Z. f. anorg. Ch.* **14**, 150, (1897).

⁷ Bjerrum, *Z. f. phys. Ch.* **53**, 428, (1905).

⁸ Cumming, *Z. f. Elektroch.* **13**, 17, (1907).

⁹ Bodländer, *Jahrb. d. Elektroch.* **11**, 499, (1904).

¹⁰ See Kohlrausch and Holborn, *Das Leitvermögen der Elektrolyte*, p. 124, (1898).

where the determination would be inaccurate, it can be diluted enough to remove it from this point, and the contents of the new solution determined. From this the concentration in the original one can be calculated.

This method has been shown to be useful in the determination of impurities in sugar and of mineral waters.¹¹ On account of the fact that the equivalent weights of the impurities likely to be present in mineral waters vary only within certain limits, it has been found that the quantity of the impurities can be estimated with a fair degree of accuracy from conductivity without analyzing the water to see which of the usual impurities are present.

This method is also useful in the case of mixtures of two salts when the conductivity of the mixture is the arithmetical mean of the single conductivities. This is often the case with nearly related compounds, which are generally difficult to separate chemically. For two substances for which this rule holds, having at equal concentrations the specific conductivities K_1 and K_2 , the conductivity of a mixture of the same total concentration would have the conductivity $K = \frac{K_1 p_1 + K_2 p_2}{p_1 + p_2}$. By

this means it has been found possible to analyze satisfactorily mixtures of potassium chloride and bromide, and sulphates of potassium and rubidium.¹² Conductivity has also been applied extensively for the determination of the solubility of very insoluble salts.¹⁰

The use of a galvanometer as an indicator depends for the end point either on a sharp change in the resistance of the cell containing the solution titrated or in the change in the electromotive force on electrodes dipping in this solution. An example of the first case is the titration of silver nitrate with a standard solution of potassium chloride.¹³ A measured quantity of a standard solution of potassium chloride is placed in a beaker with two silver electrodes. In series with the two electrodes

¹¹ Reichert, Z. f. anal. Ch. **28**, 1, (1889).

¹² Erdmann, B. B. **30**, 1175, (1897).

¹³ Salomon, Z. f. Elektroch. **4**, 71, (1898).

are connected a galvanometer and a source of electromotive force, which must be less than the decomposition value of the potassium chloride. On closing the circuit, only a very small residual current will be detected. On adding a little of the silver nitrate to the solution, silver chloride is precipitated, and a certain amount of silver ions, corresponding to the solubility of the chloride, will be in solution. We now have the cell

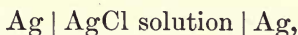

which has no decomposition point, but the quantity of silver is so small that the large resistance prevents the current from increasing to any great extent. As nitrate is added, the quantity of silver in solution changes very little until the last of the potassium chloride is used up. The first drop of silver nitrate in excess now increases the silver ions enormously, and there is a corresponding large increase in current, due to the reduced resistance of the cell. The following table shows the sharpness of the change:¹³

CUBIC CENTIMETERS OF AgNO_3	GALVANOMETER READING
3.00	15
4.40	20
5.00	16
5.50	21
5.60	20
5.65	42

The use of a galvanometer as indicator when the electromotive force changes suddenly at the end point is illustrated by the following examples:¹⁴ Suppose two beakers, one containing a tenth normal solution of mercurous nitrate, the other a definite quantity of mercurous nitrate solution to be titrated, are connected by a siphon containing tenth normal potassium nitrate. The bottom of each beaker is covered with a layer of mercury which makes contact with a platinum wire sealed in the glass.

¹⁴ Behrend, Z. f. phys. Ch. 11, 482, (1893).

Such a cell would have the electromotive force $RT \log \frac{c_1}{c_2}$, where c_1 is the concentration of the mercury ions in the tenth normal solution and c_2 is their concentration in the unknown solution. If c_1 is equal to c_2 , the electromotive force would be zero, but in general c_1 and c_2 would be somewhat different, so that there would be a reading in a galvanometer connected across the terminals of the cell. If a standard solution of potassium chloride is now added from a burette to the unknown solution, the concentrated c_2 will be diminished, due to the precipitation of the mercury, and consequently the electromotive force will increase. As the end point is approached the change in electromotive force for each drop of potassium chloride added will be greater and greater, because of the larger percentage change in the concentration. With the drop of chloride which throws out the last of the mercury, the percentage change will be the greatest of all, and there will be a corresponding change in the reading of the galvanometer. The quantity of mercury ions now in the solution is due to the solubility of the mercury chloride. Since this solubility is diminished by adding a salt with a common ion, the electromotive force will continue to increase slowly on adding more chloride, but no further sudden change will occur. This change then indicates the end point. It is evident that this method would serve equally well to determine the strength of the chloride and that the titration can be carried out, starting with potassium chloride in one beaker in place of mercury nitrate. In this case there would be a decrease in voltage at the end point instead of an increase. Bromides can be titrated as well as chlorides, but a sharp end point is not obtained with iodides.

Since the determination of the end point depends on the concentration of the ions, the final volume of the solution must be kept within such limits that a drop of the solution from the burette will cause a marked change in the galvanometer reading. Starting with tenth normal solutions, for this reason the final volume should not exceed 30 cubic centimeters, and therefore not over 10 cubic centimeters of the unknown

solution should be taken for analysis. Since the end point can be obtained only to 0.05 cubic centimeter, this means an accuracy of 0.5 per cent. In titrating potassium chloride the change in voltage at the end point is from 0.1 to 0.15 volt; in the case of the bromide it is 0.2 volt. Silver electrodes and silver nitrate can be used in place of mercury and mercury nitrates, and by this arrangement it is possible to determine directly the iodine in the presence of chloride and bromide, if an ammoniacal solution is used. Silver iodide, unlike silver chloride and bromide, is nearly insoluble in ammonia. Therefore on adding silver nitrate to an ammoniacal solution of potassium chloride, bromide, and iodide, only the silver iodide will precipitate. When all the silver iodide is precipitated, there is a sudden change in the galvanometer reading. On acidifying, the combined amount of chloride and bromide may be determined. If also the total quantity of silver chloride, bromide, and iodide is weighed, the original amount of potassium chloride, bromide, and iodide can be calculated. This procedure, however, is not very accurate for the chloride and bromide, as is shown by the following analyses.¹⁴

	GRAMS TAKEN	AMOUNT FOUND		GRAMS TAKEN	AMOUNT FOUND
KCl	0.0223	0.0246	KCl	0.0448	0.0431
KBr	0.0359	0.0314	KBr	0.0354	0.3800
KI	0.0662	0.0666	KI	0.0167	0.0169
	0.1244	0.1226		0.0969	0.0980

An exactly similar method has been shown to be useful in the titration of acids and bases.¹⁵ Neglecting the small potentials due to the liquid-liquid junctions, the electromotive force of the cell

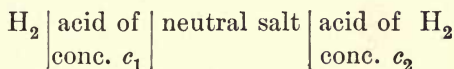

is given by the equation

$$e = RT \log \frac{c_1}{c_2},$$

¹⁵ W. Böttger, Z. f. phys. Ch. 24, 253, (1898).

assuming complete dissociation. If alkali is now added to one of these acids, the hydrogen ion concentration diminishes, causing a gradual increase in the electromotive force. As in the cases described above, there will be a sudden change in the galvanometer reading when the end point is reached. The hydrogen electrode is shown in Figure 8, and consists of palla-



FIG. 8.—Hydrogen electrode

dium-plated gold, which gives more constant values than platinized platinum. The concentration of the hydrogen soon becomes constant in the electrode, as it is not absorbed by the gold at all. In place of a hydrogen electrode as standard in the above cell, a normal electrode would do equally well.

In carrying out a titration, the acid or alkali to be titrated is placed in a beaker and the hydrogen electrode put in position so that the palladium-plated gold is partly immersed. This electrode is then connected with the standard electrode and with some means for measuring the electromotive force; for example, a Lippmann electrometer and slide wire bridge. Hydrogen is then bubbled over the hydrogen electrode till a constant potential is reached, which should require only a few minutes, and then alkali or acid, as the case may be, is added from the burette. After each addition the liquid is stirred up and the potential measured. This will be found to increase gradually till the end point is reached, where there will be a sudden change in the potential.

2. ELECTROLYTIC METHODS

The methods of analysis described above have not come into general use. The electrolytic method, on the contrary, is extensively employed, and in some cases has entirely displaced other methods. It consists in depositing by electrolysis the substance to be determined on one of the electrodes in a form that can be dried and accurately weighed. A number of

different cases may be distinguished. A metal is usually deposited on the cathode in the pure state or in a mercury cathode as an amalgam. Lead and manganese are exceptional in that they are deposited on the anode as peroxide. By the use of a silver anode, chlorine, bromine, and iodine may be obtained and weighed as the chloride, bromide, and iodide of silver, though such determinations are not often carried out.

The possibility of electroanalysis was first pointed out by Cruikshank in 1801. It was very little used, however, until subsequent to the work of Wolcott Gibbs on the electroanalysis of copper and nickel in 1864.¹ It has since formed the subject of a great number of investigations and has been employed extensively in analytical laboratories. A considerable number of improvements have been made in electroanalytical methods during this time. One of the greatest of these is the saving of time by stirring the solution during the electroanalysis, in place of trusting to electrolytic migration and diffusion to bring the ions to the electrode on which they are to be deposited. Table 3 gives an idea of the difference in time required for analyses with and without stirring.²

TABLE 3

Average Duration of Electroanalysis with and without Stirring

METAL	TIME IN MINUTES WITHOUT STIRRING	TIME IN MINUTES WITH STIRRING
Nickel	180	40
Zinc	120	15
Copper	360	20
Cadmium	180	10
Lead	60	15
Silver	180	15
Mercury	105	15
Antimony	105	30
Tin	360	20

¹ A. Fischer, *Elektrolytische Schnellmethoden*, p. 11, (1908).

² A. Fischer, *l.c.* p. 13.

A second improvement consists in increasing the number of metals that can be determined electrolytically, by substituting a mercury for a platinum cathode. Mercury was first suggested for this purpose by Wolcott Gibbs,³ but not much attention has been paid to its use until recently. With a mercury cathode the metal deposited is dissolved by the mercury and is weighed as an amalgam. E. F. Smith showed that even the highly electropositive metals belonging to the alkali and alkaline earth groups can be determined by this means.³

In order to explain the theory of electroanalysis, an acid sulphate solution of some metal standing below hydrogen in the electromotive series, given in Table 4, will first be considered.⁴ The concentration of the hydrogen ions and metallic ions is assumed to be one gram ion per liter.

TABLE 4

Electrolytic Single Potential Differences between Elements and a Solution containing one Gram Ion of the Element per Liter. The Normal Electrode on the Scale Chosen = -0.56 volt

Magnesium	2.26 ?	Arsenic	< -0.57
Aluminum	+0.999 ?	Bismuth	< -0.668
Manganese	+0.798	Antimony	< -0.743
Zinc	+0.493	Mercury	-1.027
Cadmium	+0.143	Silver	-1.075
Iron	+0.16 ⁵	Palladium	< -1.066
Thallium	+0.045	Platinum	< -1.140
Cobalt	+0.173 ⁶	Gold	< -1.356
Nickel	+0.323 ⁶	Chlorine	-1.680
Tin	< -0.085	Bromine	-1.372
Lead	-0.129	Iodine	-0.905
Hydrogen	-0.277	Oxygen	-0.670
Copper	-0.606		

Suppose two platinum electrodes are dipping in this solution, and that a gradually increasing electromotive force is applied.

³ E. F. Smith, *Electroanalysis*, p. 55, (1907).

⁴ Le Blanc, *Electrochemistry*, English translation, p. 248, (1907).

⁵ Calculated from Richards and Behr, *Carnegie Institution of Washington*, publication No. 61, p. 31, on the assumption that normal FeSO_4 is 24 per cent dissociated.

⁶ Approximately.

At first only a small diffusion current will flow, but when the decomposition voltage of the salt is reached, electrolysis will begin. The decomposition point is the sum of the potential differences at the anode and the cathode. Since the sulphate radical does not escape from the solution, the potential at the anode will remain nearly constant during the electrolysis, and the potential at the cathode at the decomposition point is equal to the potential which the precipitating metal would itself have in the solution.⁷ This will be clear from the following considerations.⁸ Suppose a metallic electrode dips in a solution of one of its salts in which the osmotic pressure of the ions of the metal is p . There will be a certain tendency for the metal to go into solution as ions, called the electrolytic solution pressure, which will be designated by P . Suppose that P is less than p ,⁹ as must be the case if the metal stands below hydrogen. A certain amount of the ions of the metal will then be deposited on the electrode, charging the solution negatively and the electrode positively. The metallic ions in solution will then be repelled by the positively charged electrode with a force k , increasing with the quantity of metal deposited. This force finally becomes so great that equilibrium is established according to the following equation :

$$P + k = p.$$

The potential difference between the electrode and solution is then given by the equation

$$e = \frac{RT}{nF} \log_e \frac{P}{p},$$

where R is the gas constant, T the absolute temperature, n the valence of the metal, and F the electrochemical constant. Suppose now the force k is diminished slightly by applying an external electromotive force in a direction tending to deposit the metallic ions on the electrode. The value of e will be

⁷ Le Blanc, *l.c.* p. 219.

⁸ See H. M. Goodwin, *Z. f. phys. Ch.* **13**, 579, (1894).

⁹ There will be no change in the method of the demonstration if $P > p$.

changed only slightly from that given by the equation above, but the metal will be deposited continuously, because the sum of the forces P and k , tending to send the metal in solution, is now slightly less than the force p , tending to cause the metal to deposit.

As the ions of the metal become more dilute, p becomes less, and the potential difference e , as well as the decomposition voltage of the solution, will consequently increase in value. The potential difference between the solution and the cathode eventually becomes so great that the value necessary for the deposition of hydrogen is reached. This potential difference, e_h , is given by the equation

$$e_h = \frac{RT}{F} \log_e \frac{P_{H_2}}{p_{H^+}} + \eta,$$

where η is the overvoltage of hydrogen on the metal depositing. After this condition has been reached, the metal and hydrogen are deposited simultaneously. The following relation then holds as long as the electrolysis continues:

$$e = \frac{RT}{nF} \log \frac{P}{p} = \frac{RT}{F} \log \frac{P_{H_2}}{p_{H^+}} + \eta.$$

If electrolysis is continued, the overvoltage η gradually increases, due to the increasing proportion of the current used to liberate hydrogen,¹⁰ and consequently p becomes less. It is evident that the reduction can never be absolutely complete, for if $p = 0$, e would be infinite.

From the equation $e = \frac{RT}{nF} \log \frac{P}{p}$, it is evident that to reduce the quantity of metal in solution to a negligible amount,—for example, to $\frac{1}{10000}$ of the original quantity,—the increase in voltage at the cathode will be $e = \frac{RT}{F} \log 10000 = 0.23$ volt for a monivalent metal, or half this value for a bivalent metal. Monivalent and bivalent metals must therefore stand respectively 0.23 volt and 0.12 volt below the

¹⁰ F. Foerster, Elektrochemie wässriger Lösungen, p. 183.

potential at which hydrogen would be deposited on the metal in question in order to be so completely separated from the solution considered.

In consequence of overvoltage and of the possibility of reducing the concentration of hydrogen ions, the potential difference at which hydrogen is deposited may, under certain conditions, be very much greater than that given in table of electrolytic potentials. Consequently, metals standing above hydrogen in the electrolytic series can be deposited in case the overvoltage of metal in question is high and the concentration of the hydrogen ions is low.

It is evident from what has been said that hydrogen plays an important rôle in electrolysis. It acts as a safety valve in preventing the potential difference at the cathode from rising above a certain value. This value depends on the concentration of the hydrogen ions and on the overvoltage, and it is therefore possible to vary this maximum voltage by changing the concentration of the hydrogen ions. For example, the potential difference of a hydrogen electrode in a normal acid solution differs by 0.81 volt from a hydrogen electrode in a normal alkali solution.¹¹ The lower the concentration of the hydrogen ions, the higher will be the voltage necessary to deposit hydrogen, and for this reason solutions of low hydrogen ion concentration must be employed for depositing electropositive metals. Such solutions are those containing ammonia, ammonium, or sodium sulphide, and potassium cyanide. In these solutions the metals form complex salts, and the concentration of their ions is greatly reduced, and a greater potential difference is also required to deposit metals from such solutions than from solutions of their simple salts. Solutions of complex salts are of great importance in electroanalysis; some metals, such as iron, nickel, antimony, and tin, can be reduced quantitatively only from such solutions.¹²

Two metals can in general be separated in an acid solution when they stand in opposite sides of hydrogen in the electrolytic series, for the hydrogen prevents the cathode potential

¹¹ Le Blanc, *l.c.* p. 209.

¹² Fischer, *l.c.* p. 31.

difference from becoming great enough to deposit the metal standing above hydrogen. When both metals are below hydrogen, they can sometimes be separated by keeping the voltage below that necessary to deposit the more electropositive metal.¹³ As explained above, if the metal to be reduced is monivalent,

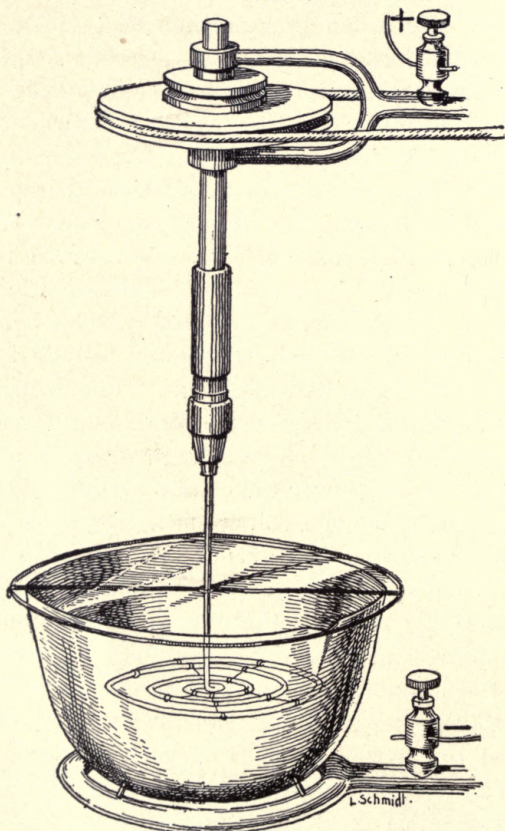

FIG. 9. — Platinum dish for electroanalysis

the potential difference between it and the solution must be at least 0.23 volt less than that of the metal from which it is to be separated, while for a bivalent metal a difference of only 0.12

¹³ Le Blanc, *l.c.* p. 309.

volt is necessary. This applies only when the two metals do not alloy with each other; if they form an alloy, the decomposition point of each is affected by the presence of the other. For this reason it is difficult to separate mercury from other metals.¹⁴

The above theory makes no attempt to explain why some metals deposit in a compact form and why others do not. This is a very important question in electroanalysis; for if the deposit does not adhere well to the cathode, it cannot be washed and

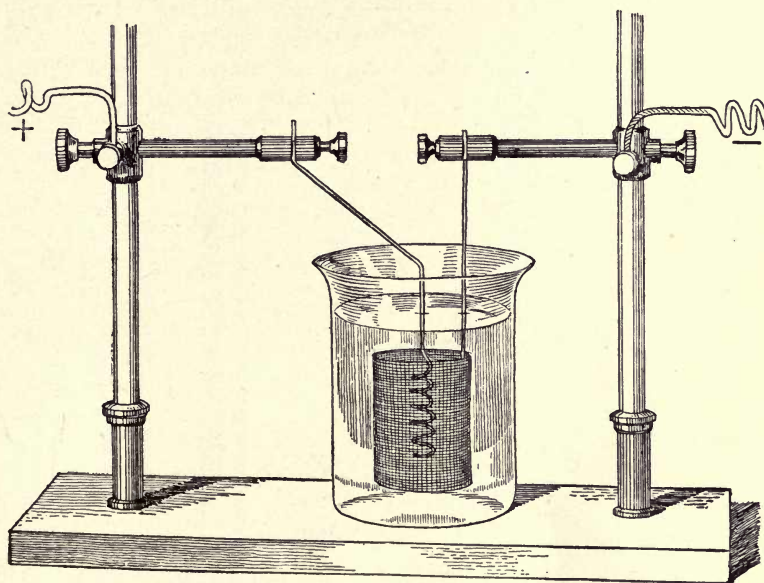

FIG. 10.— Platinum gauze cathode for electroanalysis

weighed. The structure of the deposit depends, first of all, on the nature of the metal itself. Some metals, such as zinc, cadmium, and bismuth, have a tendency to deposit in a spongy form. Others, among which is silver, deposit in large crystals. The character of the dissolved salt from which a metal is deposited is of great influence on the properties of the deposit. In general, metals are deposited in a compact, smooth layer from

¹⁴ Fischer, *l.c.* p. 37.

solutions of a complex salt, which is frequently the only reason for using them.

The temperature of the solution in electroanalysis is of great

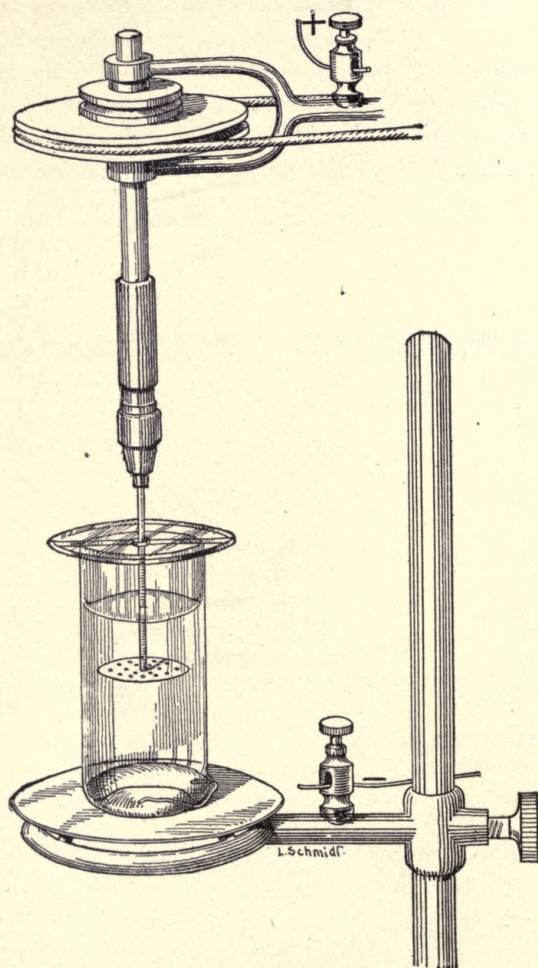

FIG. 11. — Mercury cathode for electroanalysis

importance in the case of complex salts. The velocity with which the ions are produced from the complex is not so rapid as from the simple salt, but this velocity is increased by an in-

crease in the temperature.¹⁵ In general, the more complex the salt, the greater is the effect of high temperature in accelerating the reduction.

The apparatus¹⁶ commonly used in electroanalysis consists in a platinum dish cathode 6 centimeters in diameter and 3 centimeters deep. Figure 9 represents such a dish with a rotating anode. In place of a dish, the cathode may be platinum gauze. In this case the liquid to be analyzed is held in a beaker or separatory funnel, as shown in Figure 10. Figure 11 represents an arrangement for using a mercury cathode. A beaker of 50 cubic centimeters' capacity has a platinum wire sealed into the bottom by which contact is made with the mercury and the copper plate on which the beaker is placed.

¹⁵ Fischer, *l.c.* p. 34.

¹⁶ The illustrations are taken from Edgar F. Smith's *Electroanalysis*, P. Blakiston's Son and Company (1907).

CHAPTER III

ELECTROPLATING, ELECTROTYPING, AND THE PRODUCTION OF METALLIC OBJECTS

1. ELECTROPLATING

THE object of electroplating is to cover a metal with a layer of another metal for the purpose of improving its appearance and durability. The principal metals used for the coating are nickel, copper, zinc, brass, silver, and gold.

In plating, the first step is to clean the surface thoroughly, in order to make the deposited coating adhere well. In case the surface is rough, it must be ground smooth and polished on a suitable buffing wheel. The next operation is the removal of the grease and oxide from the surface. The grease is removed by dipping in a hot solution of sodium hydrate or carbonate. The alkali is then washed off, and the object is dipped into a bath called a pickle, the purpose of which is to remove the oxide and to make it bright. The pickle varies with the metal to be treated, since a solution which works well with one metal is not necessarily suited to others. Cast iron and wrought iron are pickled in a solution made by mixing 1 part by weight of concentrated sulphuric acid with 15 parts of water.¹ A suitable pickle for zinc is simply dilute sulphuric or hydrochloric acid. Copper, brass, bronze, and German silver are treated with a preliminary pickle consisting of 200 parts by weight of

¹ Langbein, *Electrodeposition of Metals*, 4th ed. p. 162. The English measures used by Langbein are converted to the metric system when quoted. Unless otherwise stated, the formulæ given for solutions in this chapter are taken from the above work.

nitric acid of specific gravity 1.33, 1 part of common salt, and 1 of lampblack. The last ingredient has for its purpose the formation of nitrous acid. After all impurities are removed by

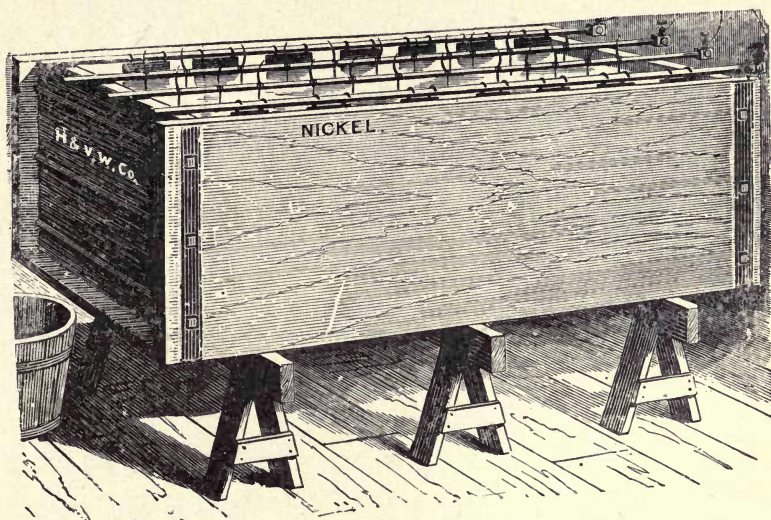

FIG. 12. — Plating tank

this bath, the object is washed in boiling water so that on removal it will dry quickly, and it is then immersed in a so-called *bright dipping bath*, to give a bright surface. This is made up of 75 parts by weight of nitric acid, of specific gravity 1.38, 100 parts of concentrated sulphuric acid, and 1 part of common salt. The object is then washed off in water and put while wet in the plating bath, where all electrical connections should have been made so that the plating begins immediately. Instead of the acid pickles following the removal of grease by alkali, brass is sometimes pickled in a hot solution of potassium cyanide, which dissolves the oxides, — somewhat

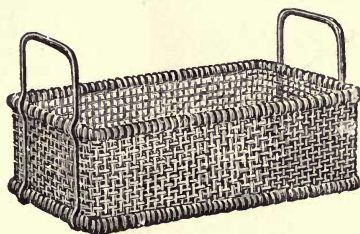

FIG. 13. — Tray for plating small objects

more slowly, however, than the acid,—but does not alter the original polish. After the plating is finished, the object is dipped in hot water and put in warm sawdust to dry.

The tanks used for holding the plating solutions are usually of wood and are lined with lead or a mixture of pitch, resin, and linseed oil. The anodes are hung on brass bars running lengthwise with the tank, and the objects to be plated are hung on similar bars between two rows of anodes, in order to plate both sides uniformly. This is illustrated in Figure 12. Small objects which are to be carefully plated are strung together in rows on wires and hung in the bath. Where not so

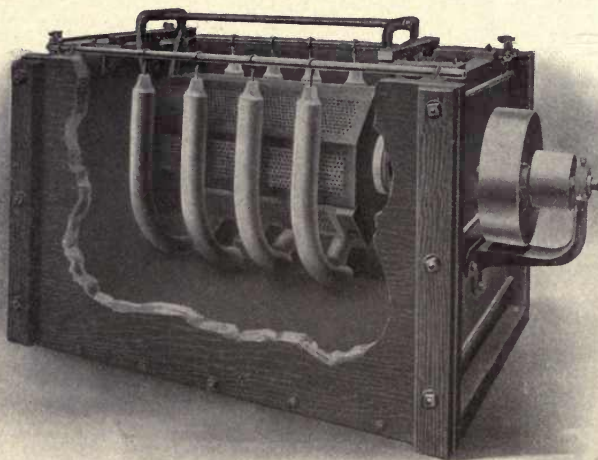

FIG. 14. — Drum for holding small objects while plating

much care is required, as in the case of small nails, it is sufficient to place them in a tray, shown in Figure 13, and hang them in the solution, or in a drum whose sides are perforated, as in Figure 14. The drum turns on its axle slowly, and the current is conducted from the pile of small objects to the axle by metal strips. Of course the tray or the axle and metal strips are also plated.

When plating is done on a large scale, the current required

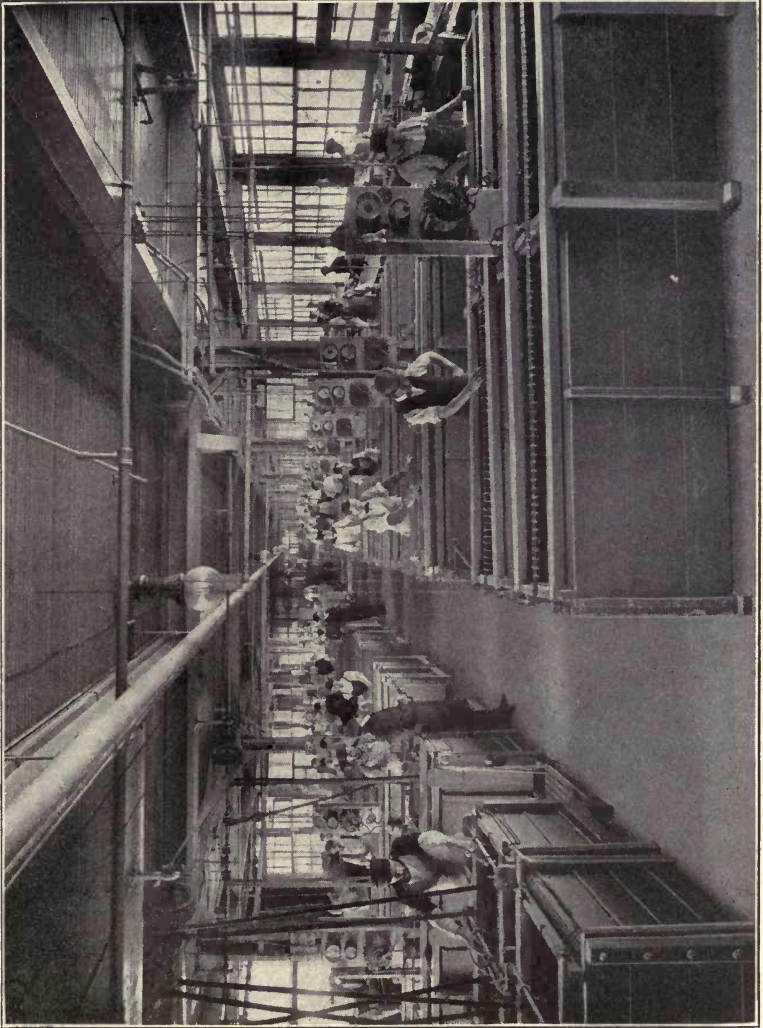

FIG. 15. — Plating plant of the National Cash Register Company

is always supplied by a dynamo, but there are the two other following methods, sometimes used for small jobs, which do not require a battery or dynamo. If a metal is dipped into a solution of a salt of a metal standing below it in the electrolytic series, the more electropositive metal will go in solution and the more electronegative will be precipitated on the former. A well-known example of this is the precipitation of copper on iron, when iron is dipped into solution of copper sulphate. This is known as *plating by dipping*. As soon as the metal is thinly coated, the action, of course, stops. In case the metal is not electropositive enough to precipitate the one in solution, the same result can be produced by connecting it with a piece of zinc placed in the solution. The zinc is dissolved as the negative pole of a battery and precipitates the metal in solution on the cathode, which is the metal to be plated. This method is known as *plating by contact*. Neither of these methods is used on a large scale.

Figure 15 shows the plating plant of the National Cash Register Company,² where nickel plating with nickel, copper, silver, and zinc are all carried out.

*Nickel Plating*¹

Nickel cannot be deposited from a strongly acid bath, since it is above hydrogen in the electrolytic series. The solution ordinarily used consists of nickel-ammonium sulphate of the formula $\text{NiSO}_4 \cdot (\text{NH}_4)_2\text{SO}_4 \cdot 6 \text{H}_2\text{O}$, with an additional amount of ammonium sulphate to increase the conductivity. The exact proportions of the salts are not important. Different receipts are given, varying from 25 to 50 parts of ammonium sulphate to 50 parts of the double sulphate, in 1000 parts of water. The solution is made acid enough to redden litmus paper faintly by adding sulphuric acid, or citric acid, as some receipts specify. This slight acidity is supposed to give a

² Met. and Chem. Eng. 8, 275, (1910).

¹ For an account of the origin of nickel plating, see Adams, Trans. Am. Electrochem. Soc. 9, 211, (1906).

whiter nickel than alkaline or neutral solutions. Baths of nickel chloride may be used for plating any metal but iron, for iron always rusts if plated in a bath of this salt. The anodes are of cast or rolled nickel.

The proper current density at the cathode is 0.6 ampere per square decimeter. The whole surface will then be perceptibly coated with nickel in two or three minutes, and a few bubbles of gas will come off continuously. If the current is too weak, the surface becomes discolored. If the current is too strong, gas is evolved more violently, and the color of the nickel soon turns dark. In large objects the current density is not uniform. The more deeply immersed in the solution, the stronger is the current, so that unless turned during plating, large objects would receive a thicker coating on the surface that is deepest in the tank. Iron is sometimes copper plated to prepare it for nickel plating. This is supposed to make the nickel adhere better, but nickel adheres perfectly well to iron if the surface is properly cleaned.²

Copper Plating

The metals usually copper plated, such as zinc, iron, and tin, are more electropositive than copper. If these are dipped into a bath of copper sulphate, they are coated immediately with copper. The copper, however, frequently comes down in a spongy form that does not adhere well, so that plating from such a bath is impossible. It is therefore necessary to reduce the concentration of the copper ions to such an extent that the copper will be relatively more electropositive than the metal to be plated, without at the same time reducing the total amount of copper in the solution. This is accomplished by using the double cyanide of copper and potassium of the formula $\text{KCu}(\text{CN})_2$. The only copper ions present come from the dissociation of the anion $\text{Cu}(\text{CN})_2$, which is very slight. Copper will therefore not be precipitated from this solution by zinc or any other metal that is to be plated. The solution can be made

² Langbein, *l.c.* p. 203.

up by dissolving cuprous cyanide in potassium cyanide to form a 3 to 8 per cent solution, or the double cyanide may be used. In either case 0.2 per cent potassium cyanide and from $\frac{1}{3}$ to 1 per cent sodium carbonate is added.³ The object of the carbonate is probably to increase the conductivity, that of the free cyanide to dissolve the anodes more readily. In case the cuprous cyanide is prepared by starting with a cupric salt, the latter must be reduced to the cuprous state before adding the cyanide; otherwise poisonous cyanogen would be liberated. Sodium sulphite is generally used for this purpose. The copper cyanide bath is heated by a steam coil to 50° to 60° C. and electrolyzed with such a high current density that there is a violent evolution of gas. Copper plating is used not only as a preliminary coating for other metals, but largely also for a final ornamental covering for iron. Various colors are then produced on the copper by dipping into a bath of sodium sulphide, producing the so-called oxidized copper.

Zinc Plating

A zinc covering is very useful as a protection for iron. It has the advantage over tin for this purpose that it is more electropositive than iron, so that in case a part of the iron becomes exposed and wet, zinc tends to dissolve in place of the iron. Iron is covered with zinc by the two methods of electroplating and of dipping in a bath of melted zinc. A third method, called sherardizing, consists in heating objects in zinc dust to 300° C.¹ The zinc deposited electrolytically is not so bright and pleasing in appearance as the dipped zinc, but it has been shown to protect the iron much more thoroughly.² A good solution for zinc plating is 200 grams of zinc sulphate, $\text{ZnSO}_4 \cdot 7 \text{H}_2\text{O}$, 40 grams of sodium sulphate, $\text{Na}_2\text{SO}_4 \cdot 10 \text{H}_2\text{O}$, and 10 grams of zinc chloride per liter, slightly acidified with sulphuric acid. The current density is from $\frac{1}{2}$ to 2 amperes per

³ Haber, Grundriss der technischen Electrochem. p. 283.

¹ Electrochem. and Met. Ind. 5, 187, (1907).

² Burgess, Electrochem. and Met. Ind. 3, 17, (1905).

square decimeter.³ The anodes are of zinc. Since a little more zinc dissolves than is deposited, the solution would lose its acidity unless a small amount of sulphuric acid is added as it is used up. The resistance may be reduced by warming to 40° or 45° C.

Brass Plating

In order to cause copper and zinc to deposit simultaneously, it is necessary that the metals should be dissolved in a solution in which a zinc and a copper plate would have potentials nearly equal. This is the case in a cyanide solution. By replacing half of the copper cyanide in the bath given above by zinc cyanide, a suitable bath for brass plating is obtained. Brass anodes are used. If a current density of only 0.1 ampere per square decimeter is used, only a small amount of zinc is deposited with the copper; with 0.3 ampere per square decimeter, however, the deposit contains only 80 per cent of copper. Increasing the current density changes the composition of the brass only slightly, though the color becomes greenish.¹

There is quite a large resistance to be overcome in depositing both copper and zinc from their cyanide solutions, as measured by the potential difference that must be produced between the solution and the cathode. This potential difference is found to be greater than the potential of the metal dipping into its cyanide solution when no current is flowing, and this resistance increases with the current density, so that the potential is soon reached at which hydrogen is deposited on the copper or zinc cathode, in place of the metal.²

Zinc and copper are deposited together from a solution of zinc and copper cyanides considerably below the potential of a pure zinc electrode, which shows electrolytic brass is an alloy and not a mixture of particles of pure copper and pure zinc.²

³ Foerster, *Elektrochemie wässriger Lösungen*, p. 255.

¹ Foerster, *l.c.* p. 253.

² Spitzer, *Z. f. Elektroch.* 11, 367, (1905).

Silver Plating

The double cyanide of potassium and silver is universally used for silver plating, because of the smooth deposit obtained from this solution. As stated in Chapter I, silver is deposited from a nitrate solution in a granular form entirely unsuited for plating. A solution containing from 1 to 5 per cent silver, as potassium silver cyanide, $KAg(CN)_2$ with $\frac{1}{2}$ per cent of free potassium cyanide, has been found satisfactory.¹ Too little or too much free cyanide causes a bad color in the deposit. The anodes are silver, and the current density on the cathode is from 0.15 to 0.5 ampere per square decimeter. Silver is deposited only on a copper surface. Other metals than copper or copper alloys which are to be silver plated are first copper plated. In order to make the silver adhere to this surface it must be amalgamated before plating. This is accomplished by dipping into a *quicking bath*, consisting of a solution of 30 grams of the double cyanide of potassium and mercury, $K_2Hg(CN)_4$, and 30 grams of potassium cyanide, in one liter of water. Articles are washed after quicking and placed immediately in the silver-plating bath.

Gold Plating

The solution used for gold plating consists of the double cyanide of gold and potassium, $KAu(CN)_2$. This can be prepared by precipitating gold with ammonia in the form of fulminating gold, $AuNH \cdot NH_2 + 3 H_2O$, from a solution of gold chloride. This is washed and dissolved in potassium cyanide, and the ammonia boiled off. The concentration of gold varies between 0.35 and 1 per cent of gold, with twice as much potassium cyanide.¹ The anodes are of gold, and the current density on the cathode is about 0.2 ampere per square decimeter. Gold plating is carried out in both hot and cold baths. The metal deposited from a hot solution is more dense, uniform, and of a richer color.

¹ Haber, *l.c.* p. 284.

¹ Haber, *l.c.* p. 287.

2. GALVANOPLASTY

Galvanoplasty, or the art of reproducing the forms of objects by electrodeposition, was discovered by Jacoby of Petersburg in 1838. It is now used extensively for electrotyping and the production of copper tubes and of parabolic mirrors.

Electrotyping

The first operation in making an exact duplicate of type set up ready for printing is to take an impression of the type in wax. The wax sometimes used is ozokerite. The thickness of the sheet of wax used for the purpose is about half an inch. After this has been carefully inspected to see that every letter is perfect, fine graphite powder is well worked into the surface by soft brushes. This is done in several operations, by machines and by hand. Copper sulphate is then poured over the surface and iron powder sprinkled over it to produce a thin layer of copper, which will make the whole surface more conducting than the graphite could do. This is an example of the use of plating by contact, explained above. The sheet is then hung in an acid copper sulphate bath and electrolyzed for an hour and a half. It is then removed from the tank, and the wax is warmed and separated from the thin copper sheet. The copper is next backed to give it mechanical strength by pouring on it an alloy of lead and antimony. The subsequent purely mechanical operations of making the sheet perfectly level, so that each letter will print, and of mounting them on wood need not be described in this place. The advantages of electrotyping are the saving of wear on the type, and the fact that a small stock of type will prepare unlimited number of pages; for when once a page is electrotyped, the type used for preparing this page may be used over again for another. Nearly all books are now printed in this way.

Copper Tubes,¹ Foil, and Wire

Tubes are produced by depositing copper evenly on a cylindrical cathode, and the copper is removed when it has become sufficiently thick. In order to keep the outer surface of the

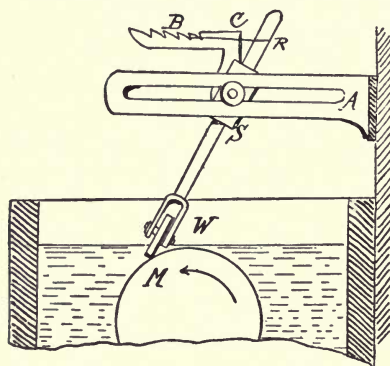

FIG. 16. — Agate wheel for polishing tubes during electrolysis

tube smooth, it must be polished during the electrolysis; this is done in the Elmore² process by means of an agate wheel whose edge bears on the tube, as shown in Figure 16. The wheel turns on its axis and polishes the surface over which it travels. In the process of the Société des Cuivres de France, the polishing is obtained by allowing two tubes to rotate in contact with each other.

Polishing not only keeps the surface smooth, but also makes the use of higher current densities possible.

The tubes made by the Elmore process are usually 3 meters long and vary up to 1.6 meters in diameter.³ In order to separate the finished tube from the axle, the surface of the axle must be specially prepared so as to conduct and yet not make the contact with the copper deposited too intimate. This may be done by slightly oxidizing the metal on which the copper is precipitated. The tube can then be worked loose by pressure.

Numerous patents have been taken out for the production of copper wire, but only those would be of special interest which have proved their value in actual use. It is not apparent, however, from an examination of the literature that any electrolytic process for making copper wire is in actual use, and the same

¹ See Pfannhäuser, *Die Herstellung von Metallgegenständen auf Elektrolytischem Wege*, Engelhardt Monographs, Vol. 5, (1903).

² *Electrochemist and Metallurgist*, 3, 151, (1903).

³ Pfannhäuser, *l.c.* p. 109.

is true in the case of metal foils. Nevertheless a few of the best known patents will be described.

In 1891, J. W. Swan patented a method of producing copper wire, which consists in depositing copper on a wire so as to thicken it, and in then drawing down the wire to the original size. The apparatus is so planned that this is a continuous process. Saunders has patented a method in which the copper is deposited on a conducting spiral wound on a drum. The wire is stripped off when sufficiently thick, and is then drawn down.

For the production of metal foil, Reinfeld's patent calls for an oxidized nickel cathode. When a thin deposit of metal has formed, it can be stripped off. The principle of Endruweit's method is the same. The cathode is a metal ribbon which passes through an oxidizing solution, then through a bath for cleaning, after which the metal foil is deposited upon it.

Besides the production of tubes the only other galvanoplastic industry which is of importance is the production of parabolic mirrors.⁴ This process has been worked out by Sherard Cowper-Coles. It saves the expensive grinding of a parabolic surface for each mirror, for by this method any number of parabolic mirrors can be produced from one mold. The details of the process are the following: First a perfectly parabolic glass surface is prepared by pressing a glass plate about 3 centimeters thick, and hot enough to be soft, into a cast-iron mold of approximately a parabolic form. The glass surface which was next the iron is now made perfectly parabolic by polishing on a lathe with more refined means as the surface approaches nearer to perfection. The next step is to clean the surface and cover it with a thin layer of metallic silver by the ordinary process used in silvering. The glass form, covered on the parabolic side with silver, is then placed in a copper sulphate bath, rotated at the rate of five times a minute, and copper plated. The object of the copper is to give the mirror mechanical strength. In order to separate the silver and copper from the glass, they are placed in a water bath and heated to 50° C.

⁴ See Coles, Engelhardt Monographs, Vol. 14, (1904).

The unequal expansion easily separates the glass from the metal. The concave side is now a perfect mirror, but the silver would soon tarnish and must therefore be protected. For this purpose a thin layer of platinum is deposited on the silver electrolytically. The solution used for platinizing is ammonium platonic chloride in sodium citrate. The only process that now remains to make the mirror complete is its mounting, the description of which in this place is unnecessary.

CHAPTER IV

ELECTROLYTIC WINNING AND REFINING OF METALS IN AQUEOUS SOLUTIONS

1. THE WINNING OF METALS

ATTEMPTS have been made to extract metals from their ores by electrolyzing the ore as an anode, in the hope that it would dissolve and be deposited at the cathode in the pure state. No such process has ever been successful, but as failures are instructive, the three best known processes for the electrolytic winning of metals will be briefly described.

An attempt to put the Marchese process in operation is described by Cohen.¹ The matte from which the copper was to be won had the following composition:

Copper	17.20	per cent
Lead	23.70	per cent
Iron	29.18	per cent
Sulphur	21.03	per cent
SO ₃	0.69	per cent
Silica	0.88	per cent
Silver	0.062	per cent

The solution was obtained by treating a matte similar to the above with dilute sulphuric acid, and consisted principally of copper and ferrous sulphate. On electrolyzing, copper deposits on the cathode and copper and iron are dissolved at the anode as sulphates. In order to make the oxidizing power of ferric sulphate available, the matte from which the solution is

¹ Z. f. Elektroch. 1, 50, (1894).

made is treated with the electrolyte in which ferric sulphate has accumulated. The ferric sulphate is reduced to ferrous sulphate, and cuprous sulphide and oxide is changed to copper sulphate. The solution is then returned to the electrolyzing baths.

Favorable results were obtained in the laboratory in Genoa, and on a larger scale at Stolberg from February to April, 1885. The copper obtained was 99.92 per cent pure. A large plant was then built to produce 500 to 600 kilograms of copper in 24 hours with 58 vats, 2.2 meters long, 1 meter deep, and 1 meter wide. At first all expectations were realized. The baths worked well and the copper produced was pure. Within a few days, however, the voltage across the baths began to rise, in some cases to 5 volts. This was due to the deposition of sulphur on the anode and the disintegration of the anode due to the dissolving of the copper and iron. Large pieces became detached from the anode and fell to the bottom of the tank, filling up the space between anode and cathode and producing a short circuit. The copper also became impure, containing antimony, bismuth, lead, iron, zinc, and sulphur. Insoluble lead electrodes were then tried, but the polarization due to the formation of lead peroxide was excessive, and the yield in copper fell to 60 per cent of the theoretical amount. The Siemens and Halske process was then tried by the same company. The principal difference between this and the Marchese process is the use of insoluble anodes and the separation of anode and cathode by a diaphragm. Copper is deposited from a solution containing ferrous sulphate and copper sulphate. The solution then circulates to the anode, where ferrous sulphate is oxidized to the ferric state. The oxidized solution is then used to dissolve more copper from the ore. For three months an attempt was made to carry out this process, but it was finally given up, partly at least on account of mechanical difficulties, such as the tearing of the diaphragm and disintegration of the carbon anodes.

The Hoepfner² process is similar in principle to the Siemens

² Z. f. angew. Ch. p. 160, (1891); Chem. Zeitung p. 1906, (1894).

and Halske process. The unroasted ore is dissolved by cupric chloride, and the cupric chloride is reduced to cuprous chloride. This is kept in solution by sodium chloride. The action of the cupric chloride is the following:³

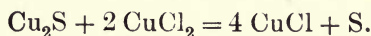

The solution containing cuprous chloride is electrolyzed in the cathode compartment, where it loses part of its copper. The solution then circulates to the anode compartment, from which the cathode compartment is separated by a diaphragm, and the remaining copper is oxidized to cupric chloride. The anode solution is then ready for treating the ore a second time. This process was also tried on a large scale, but seems to have failed largely on account of mechanical difficulties, especially with the diaphragm.

The Winning of Zinc

Zinc is one of the few metals in the winning of which electrolysis may take an important part. This is due to the fact that in the ordinary metallurgical process a loss amounting sometimes to 25 per cent of the metal occurs.¹ Only under peculiar circumstances is zinc refined by electrolysis, on account of the fact that commercial zinc never contains noble metals, and also because there is not much demand for zinc of a high degree of purity.²

In either a refining or a winning process it is of the first importance to find the conditions under which a smooth deposit of the metal can be obtained.

Under certain conditions zinc is deposited in a spongy form that cannot be melted down on account of its tendency to oxidize.³ The nature of sponge zinc is still unknown,⁴ though the conditions under which it forms and the ways to avoid it

³ See Blount, *Practical Electrochemistry*, p. 81, footnote.

¹ Foerster, *Elektrochemie wässriger Lösungen*, p. 289.

² Günther, *Die Darstellung des Zinks*, p. 26.

³ Mylius and Fromm, *Z. f. anorg. Ch.* **9**, 144, (1895).

⁴ Foerster, *l.c.* p. 291.

have been the subject of numerous investigations. The factors which determine the character of the deposit are the temperature, the current density, the concentration of the solution, and the impurities present.

From a dilute solution of zinc sulphate, the zinc is always deposited in a spongy state⁵ with a simultaneous evolution of hydrogen. With a low current density even in a strong solution the same is true. High temperature,⁶ oxidizing agents, and metals more electronegative than zinc⁷ cause the formation of sponge. A slight acidity tends to prevent the sponge from forming.⁸ Therefore the conditions to obtain zinc in a compact form are high current density, low temperature, a concentrated, slightly acid solution, and the absence from the solution of oxidizing agents or more electronegative metals than zinc. As to the limits of current density allowable, different results have been obtained by different observers. According to Mylius and Fromm,⁹ the current density must be at least one ampere per square decimeter to prevent the formation of spongy zinc, while Hasse¹⁰ obtained solid deposits with one third this density. The strength of the solution is not given. Kiliani's¹¹ deposits were spongy at a current density of 2.7 amperes per square decimeter, from a zinc sulphate solution of specific gravity 1.38. Nahnsen seems to have investigated the condition of deposit with regard to temperature and current density more systematically than any one else. He obtained the following results :

⁵ Kiliani, *Berg- und Hüttenm. Ztg.*, 1883, p. 250.

⁶ Nahnsen, *Berg- und Hüttenm. Ztg.* 1891, p. 393.

⁷ Mylius and Fromm, *l.c.* p. 165.

⁸ Mylius and Fromm, *l.c.* p. 167.

⁹ Mylius and Fromm, *l.c.* p. 169.

¹⁰ *Z. f. Berg-, Hütten- und Salinenwesen*, 45, 327, (1897).

¹¹ Kiliani, *l.c.* p. 251.

TABLE 5

AMP. PER SQ. METER	0°	10°	20°	30°
10	Firm	Incipient sponginess	Spongy	Spongy
50	Firm	Spongy	Incipient sponginess	Spongy
100	Firm	Firm	Spongy	Incipient sponginess
150	Firm	Firm	Firm	Spongy
200	Firm	Firm	Firm	Firm

In the winning of zinc by electrolysis, the steps are to roast the ore if it is insoluble, to dissolve the resulting product, and to deposit the zinc from the solution by electrolysis with insoluble anodes. A process devised by Hoepfner to carry out the winning of zinc in this way was in operation for a while in Fürfurth, Germany, and is now in operation in Hruschau, Austria, and at the works of Brunner, Mond, and Company, at Winnington, England.¹² The process consists in electrolyzing zinc chloride with carbon anodes, separated by a diaphragm from the cathode.¹³ One great difficulty is to obtain a diaphragm that will last, and it seems doubtful if this problem has yet been satisfactorily solved. The chlorine obtained from the anode compartments is collected and used in making bleaching powder.¹⁴

2. THE ELECTROLYTIC REFINING OF METALS

Copper Refining

The object of copper refining is to get as pure a copper as possible for electric conductors, since a very small amount of impurity lowers the conductivity materially,¹ and also to obtain the gold, silver, and other impurities.

¹² Kershaw, *Electrometallurgy*, p. 272.

¹³ For a detailed description see Günther, *l.c.*

¹⁴ Kershaw, *l.c.* p. 273.

¹ Addicks, *Electrochem. Ind.* 1, 580, (1903).

In copper refining, copper anodes containing only a small percentage of impurities are electrolyzed with the proper current density in an acid copper sulphate bath of suitable concentration. The copper and the soluble impurities, which are not more electronegative than copper, dissolve, while the insoluble impurities become detached from the anode and fall to the bottom of the tank, forming what is known as anode mud or slime. The soluble impurities gradually accumulate in the solution till purification is necessary. As long as the impurities are below a certain concentration in the solution, the copper deposited on the cathode is of much greater purity than that of the anode. The reason the impurities in solution are not deposited when dilute is that the voltage drop from solution to cathode has not reached the decomposition point of these ions. The decomposition point of an ion changes with its concentration by the amount $\frac{0.058}{n}$ volt at 17° C., where n

the valence of the metal, for a change in concentration of the ion in the ratio of one to ten. As the concentration of any given ion increases, its decomposition point is gradually lowered until it equals the potential difference between the solution and the cathode. At this point it is deposited with the copper. But not all of the impurities found in the cathode are deposited from the solution. Some are taken up from the slime, of which a certain amount is always suspended in the solution, on account of the circulation of the electrolyte. This is true in the case of silver and gold.²

It will be interesting next to see what the impurities of anode copper commonly are, how they behave when the anode dissolves, and what impurities are deposited on the cathode. The following table gives a representative composition of anodes for American refineries :

Copper	98-99.5 per cent
Silver	0 to 300 oz. per ton
Gold	0 to 40 oz. per ton
Arsenic	0 to 2 per cent

² Addicks, *Electrochem. and Met. Ind.* 4, 16, (1906).

with small amounts of antimony, bismuth, iron, nickel, sulphur, selenium, tellurium, and silicon.

A more specific case is given in the following tables, showing the composition of the anodes and cathodes at the Great Falls and the Anaconda refineries.³

COMPOSITION OF ANODES IN PER CENT

	GREAT FALLS	ANACONDA
Copper	99.27	99.25
Arsenic and antimony	0.07	0.10
Oz. silver per ton	61.40	90.00
Oz. gold per ton	0.22	0.50

For comparison the cathodes are given below.

COMPOSITION OF CATHODES IN PER CENT

	GREAT FALLS	ANACONDA
Copper	99.95	99.96
Arsenic	0.0012	0.0009
Antimony	0.0033	0.0023
Oz. silver per ton	1.0	0.25

The behavior of these impurities in the anode under the action of the current was first determined by Kiliani.⁴ His experiments were carried out with a constant current density on the anode of 20 amperes per square meter and with a solution of 150 grams of copper sulphate and 50 grams of concentrated sulphuric acid per liter. His results will be briefly recapitulated. Excepting the above statement regarding current density and concentrations, his method of experimenting is not indicated.

Cuprous oxide is not attacked by the current, but goes into the slime, where it is slowly dissolved, making the bath richer in copper and poor in sulphuric acid.

³ H. O. Hofman, *Electrochem. Ind.* 1, 416, (1903).

⁴ *Berg- und Hüttenm. Ztg.* 1885, pp. 249, 261, and 273.

Copper sulphide and selenium sulphide go into the slime.

Silver, gold, and platinum go into the slime.

Bismuth and bismuth oxide go partly into the slime and partly into solution, from which they are precipitated as a basic salt.

Tin goes into solution and precipitates, on standing, as basic salt.

Metallic arsenic goes into solution as arsenic acid. If present to less than one per cent in the anode, it goes more rapidly into the slime.²

Antimony behaves like tin.

Lead goes into the slime as insoluble sulphate.

Iron, zinc, nickel, and cobalt are dissolved by the current and remain in solution.

A common composition of the slime is the following:²

- 40 per cent silver,
- 2 per cent gold,
- 25 per cent copper,
- 5 per cent selenium and tellurium,
- 10 per cent arsenic and antimony,
- 18 per cent lead, silicon, sulphuric acid, etc.

The slimes at Great Falls and Anaconda are the following:³

GREAT FALLS	ANACONDA
18 per cent copper	10 per cent copper
15,000 oz. of silver per ton	18,000 oz. of silver per ton
38 oz. of gold per ton	100 oz. of gold per ton

The large amount of copper in the slime is due to part of the dissolving in the cuprous state and then breaking up into cupric ions and finally divided copper according to the equation :

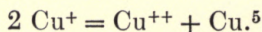

The slimes are worked up for the gold, silver, copper, and arsenic. The gold and silver have to be purified, and for this

⁵ Foerster, Z. f. Elektroch. 3, 497, (1907); Wohlwill, *ibid.* 9, 311, (1903).

reason copper refineries sometimes have a plant for silver refining.⁶

The electrolyte used in copper refining consists of a solution of copper sulphate and sulphuric acid. The quantity of copper sulphate ($\text{CuSO}_4 + 5 \text{H}_2\text{O}$) varies between 12 and 20 per cent, the acid between 4 and 7 per cent.⁷ Table 6 gives the conductivities per centimeter cube of two acid copper sulphate solutions, one containing approximately the smallest amounts of salts and acid used, and the other, the largest amounts.⁸

TABLE 6

TEMP. CENTIGRADE	CONDUCTANCE OF A SOLUTION CONTAINING	
	3.75% H_2SO_4 12.5% $\text{CuSO}_4 \cdot 5 \text{H}_2\text{O}$ Sp. gr. at 22.2, 1.007	9.2% H_2SO_4 18.3% $\text{CuSO}_4 \cdot 5 \text{H}_2\text{O}$ Sp. gr. at 21.2, 1.199
25	0.1573	0.3260
40	0.1752	0.3754
60	0.1895	0.4252

This shows the limits between which the conductance of a copper sulphate solution used in copper refining would probably lie. The actual composition of the baths at Great Falls and Anaconda are the following :

GREAT FALLS	ANACONDA
170 grams sulphuric acid per liter 42 grams copper per liter	150 grams sulphuric acid per liter 40 grams copper per liter

A small amount of hydrochloric acid is also added to prevent the solution of silver and antimony, as well as to produce a smoother deposit on the cathode. Where a current density as low as ten amperes per square foot is employed, as at Anaconda,

⁶ Easterbrooks, Silver Refining Plant of the Raritan Copper Works, *Electrochem. and Met. Ind.* **6**, 277, (1908).

⁷ Ulke, *Die Elektrolytische Raffination des Kupfers*, p. 42, (1904).

⁸ Thompson and Hamilton, *Trans. Am. Electroch. Soc.* **17**, 292, (1910).

the electrolyte can be used for many years without purification,⁹ while with a 60 per cent higher value some part must be renewed frequently. A foul solution at Great Falls has the following composition :³

51.80 grams copper per liter,
 13.20 grams iron per liter,
 14.00 grams arsenic per liter,
 0.62 grams antimony per liter,
 48.00 grams sulphuric acid per liter.

This shows that the impurities can become fairly concentrated before purification is necessary.

In those refineries where the electrolyte has to be purified, the operation of purifying is carried out continuously on a certain fraction of the total amount of electrolyte. The copper is separated either by electrolyzing with lead anodes or by crystallizing as copper sulphate.

The circulation of the electrolyte, which is maintained by arranging the vats as in Figure 17, is an important factor. With no circulation the solution at the cathode would become

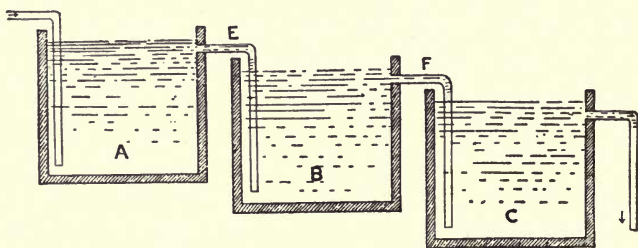

FIG. 17. — Circulation of electrolyte

too dilute for satisfactory deposition, while with too much circulation the slime would be stirred up and contaminate the cathode. The higher the current density the higher must be the rate of circulation. This is illustrated by the fact that at Great Falls, with tanks $9\frac{3}{4}$ feet in length, $2\frac{1}{3}$ feet in width, and $3\frac{2}{3}$ feet in depth, where the current density is about 40 amperes per square foot, the circulation through a tank is 6 gal-

⁹ Magnus, Trans. Am. Electrochem. Soc. 4, 77, (1903).

lons per minute; while at Anaconda, with tanks $8\frac{1}{2}$ feet in length, 4 feet in width, and 4 feet in depth and a current density of 10 amperes per square foot, the circulation is 3 gallons per minute.³ At the Raritan Copper Works the rate of circulation would empty a tank in $1\frac{3}{4}$ hours.¹⁰

There are two different systems of arranging the electrodes used in refining copper, known as the series and the multiple systems. In the series system a number of copper anodes are suspended in the bath at equal distances apart, and only the two end ones are connected to the dynamo, as shown in Figure 18.

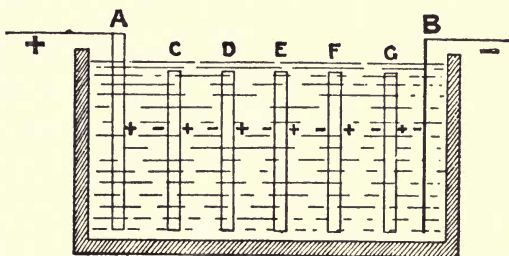

FIG. 18. — Series system

The current then dissolves copper from the first plate, which is connected directly to the opposite pole of the dynamo, and deposits it on the near side of the next plate. The other side

of the second plate is dissolved and deposited on the third, and so on throughout the whole series. In order to separate the deposited copper from that which has not been dissolved, the sides

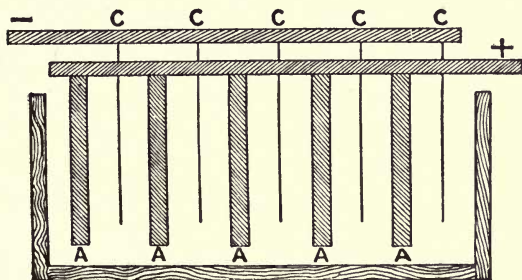

FIG. 19. — Multiple system

facing the positive pole are covered with some conducting material which allows the refined copper to be stripped off. Of course in this system the tanks cannot be lined with conducting material, for such a lining would cause a short circuit. Another difference between these tanks and those of the multi-

¹⁰ Addicks, *Min. Ind.* 9, 270, (1900), and Ulke, *l.c.* p. 63.

ple system is their greater size. Those at the Nichols Works in Brooklyn are 16 feet long, 5 feet wide, and $5\frac{1}{2}$ feet deep.¹¹ The anodes are from $\frac{1}{4}$ to $\frac{3}{8}$ of an inch thick, and are placed from $\frac{1}{2}$ to $\frac{9}{10}$ of an inch apart.

In the multiple system the anodes and cathodes are arranged alternately, as shown in Figure 19. All the anodes are connected to the positive pole of the dynamo and the cathodes to the negative pole. The cathodes are thin sheets of electrolytic copper, made by depositing copper on lead or copper covered with a conducting material from which the copper can be separated. At the Raritan Copper Works⁶ the cathodes remain in the tanks 14 days. At the end of 28 days 13 per cent of the anodes are still undissolved, but at this stage they are removed and cast into fresh anodes.

In order to reduce the power required, the temperature of the baths in practice is between 40° C. and 50° C., though from some experiments of Bancroft¹² 70° C. and a current density between 3.5 and 3.75 amperes per square decimeter would seem to be more economical as far as power is concerned.

The voltage between the anode and cathode varies between 0.1 and 0.3 volt, depending on current density, temperature, distance between anode and cathode.¹³ This voltage is used up partly in overcoming the ohmic resistance of the bath and partly in overcoming the electromotive force of polarization. Polarization, of course, varies with the current density and the rate of circulation, but a representative value is 0.02 volt.¹⁴

The actual cost of refining 98 per cent copper has in recent years been reduced from \$20 to \$4 or \$5 a ton. This improvement is due to the more economical use of power¹⁵ and the more practical handling of the material. About 24 per cent of the power is still lost in the contact resistance.¹⁶

¹¹ Ulke, *l.c.* p. 5 *et seq.*

¹² Trans. Am. Electrochem. Soc. 4, 73, (1903).

¹³ Ulke, *l.c.* p. 43.

¹⁴ Addicks, Trans. Am. Electrochem. Soc. 7, 62, (1905).

¹⁵ Ulke, *l.c.* p. 3.

¹⁶ Magnus, Electrochem. Ind. 1, 561, (1903).

Nickel Refining

If nickel is deposited from a cold solution of nickel chloride or sulphate in a layer more than 0.01 millimeter thick, it has a great tendency to separate from the underlying metal, but this difficulty can be overcome by heating the solution from which the nickel is deposited to 60° or 70°.¹ At this temperature and with a current density of from 0.01 to 0.02 ampere per square centimeter, nickel is obtained of such ductility that it can be rolled. Nickel is more electropositive than hydrogen, and the overvoltage of hydrogen on nickel is not great. Nickel must therefore be deposited from a very weakly acid solution.

The Balbach Company at Newark, New Jersey, was one of the earliest refiners of nickel, as well as of copper. Nickel was refined by this company from 1894 to 1900 by a secret process. The product contained 0.25 per cent iron and a small amount of cobalt.² Another process that was in successful operation for some time is that of David H. Brown.³ This was not a refining operation, as it had for its object the separation of nickel and copper in an ore. The ore contained 2 per cent nickel and as much copper. Anodes were made consisting of 54.3 per cent copper, 43.08 per cent nickel, and the remainder of iron and sulphur. They were 75 centimeters in width, 60 in length, and 2½ in thickness. The connections were those of the multiple system. The tanks were of concrete, 256 centimeters long, 85 centimeters wide, and 67½ centimeters deep. Each held 1.534 cubic meters of electrolyte. The circulation was effected as in copper refining, by overflow from bath to bath. The solution at one time consisted of 44.3 grams of copper per liter as cuprous chloride, 55.6 grams of nickel as nickel chloride, and 100 grams of sodium chloride, but these concentrations were subsequently modified. The voltage for 24 baths in series was 6 to 10 volts and the current 500 amperes. In this stage copper was deposited in a coherent but not dense form. The

¹ Foerster, *Z. f. Elektroch.* 4, 160, (1897).

² Ulke, *Electrochem. Ind.* 1, 208, (1903).

³ Haber, *Z. f. Elektroch.* 9, 392, (1903).

relative amount of copper and nickel in the solution flowing into the baths was the same as that in the anodes. On leaving the baths the ratio of copper to nickel was reduced to 1 : 80. Sodium sulphide was then added to the solution, to precipitate the 1.25 per cent of copper still remaining. After filtering, the solution was treated with chlorine to change the iron to chloride, which was precipitated with sodium hydrate and filtered. As much as possible of the sodium chloride was then removed by concentrating the solution by evaporation. The nickel was then obtained by electrolyzing the hot solution with graphite anodes. The current yield was 92.5 per cent of the theoretical. The chlorine produced at the anode was used in another part of the process. The nickel obtained was of the following average composition: 99.85 per cent nickel, 0.085 per cent iron, 0.014 per cent copper, and was free from arsenic, sulphur, and silicon.

Up to 1902, 454 kilograms of nickel were produced daily in Cleveland, when it was discontinued by the International Nickel Trust, in favor of the Orford⁴ Process with which it formerly competed. The nickel produced by the latter process has varying compositions, as the following table of percentage composition shows:

NICKEL AND COBALT	COPPER	FLUORINE	CARBON	SULPHUR	SILICON
98.91	0.13	0.40	0.23	—	0.05
98.34	0.41	0.93	—	0.078	—

This is pure enough for anodes in nickel plating and the manufacture of steel. For other purposes, however, such as making German silver, a better quality is required, and since 1906 the Orford Copper Company has taken up the electrolytic refining of nickel.⁵ Very little is known about the details of

⁴ This process depends for the separation on the fact that sodium sulphide forms double compounds with iron and copper sulphides, which float on the top of melted nickel sulphide.

⁵ Electrochem. and Met. Ind. 4, 26, (1906).

this process. The cathodes are said to be 3 by 4 feet in area and $\frac{1}{4}$ inch in thickness, and their purity is 99.5 per cent. The nickel is deposited from a chloride solution.

Silver Refining

Two different cases arise in refining silver: one being the problem of separating silver and copper in an alloy consisting mainly of these two metals; the other, the separation of silver from relatively small amounts of gold and platinum. From the relative positions of silver and copper in the electrolytic series, it is evident that if the attempt were made to separate these metals by electrolyzing an anode containing approximately equal amounts of each in a solution which dissolves them both, more silver would deposit on the cathode than dissolves at the anode. The copper in solution would therefore become so concentrated that its decomposition point would be reduced to a value equal to that of silver. In carrying out this operation it is therefore necessary either to find a solvent in which only one of the metals dissolves, or to precipitate one of them by some other means. In 1877 to 1878 Wohlwill¹ succeeded in separating silver and copper at the Norddeutsche Affinerie in alloys containing as much as 30 per cent of silver. The solution was copper sulphate, more dilute than is used in refining copper, and the current density was lower. A sponge rich in silver remained adhering to the anode, which had to be removed mechanically, and the copper was deposited at the cathode. Another method for accomplishing the same result, due to Dietzel² and used at the Gold- und Silber-Scheide Anstalt at Pforzheim, depends on dissolving both copper and silver in a weakly acid solution of copper nitrate at the anode and carrying this solution immediately into another vessel where the silver is precipitated by contact with copper. After the silver has been thus completely removed, the copper nitrate solution is made slightly acid and enters the electrolyzing vat, where a certain amount of the copper

¹ Borchers, *Electric Smelting and Refining*, 2d English ed. p. 309 *et seq.*

² Z. f. Elektroch. 6, 81, (1899-1900).

is deposited as it passes the cathode. The arrangement is shown in Figure 20, which represents a cross section of the dissolving vessel. *KK* are the rotary cylindrical copper cathodes, coated with a thin layer of grease or graphite, on which the deposition of copper takes place. When the copper grows out in the form

of trees, it is knocked off.

The copper cylinders are suspended on flanged contact rollers, which, when set in motion, cause the cylinders to rotate. Thus the shafts and driving mechanism are out of contact with the solution. *P* is a loose bottom for supporting the material to be treated, *S*, and is of hard rubber, celluloid, or glass. The plates *P* are provided with platinum

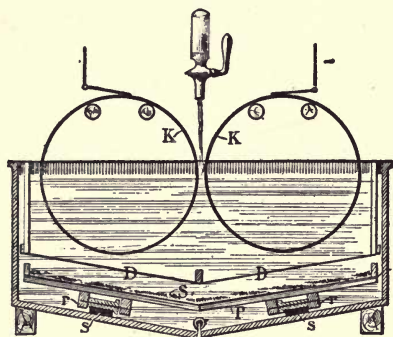

FIG. 20. — The Dietzel apparatus for silver refining

wires for conducting the current to *S*. *DD* are filter cloths, the object of which is to catch any copper falling from the cathodes and to prevent any of the anodic silver solution from rising to the cathode. The desilverized electrolyte is admitted from above, as shown. A small amount of silver — 0.03 per cent — is deposited at the cathode with the copper. The solution contains from 2 to 5 per cent of copper and 0.05 to 0.4 per cent of free nitric acid. The current density is 1.5 amperes per square decimeter (14 amperes per square foot) and the voltage is from $2\frac{1}{2}$ to 3 volts.

The electrolytic separation of silver and gold was first carried out by Wohlwill in 1871. These experiments were made simply to reduce silver from the solution obtained by boiling the metal in sulphuric acid. The electrodes were platinum, and the silver was deposited in loose, pure crystals. When the silver became dilute, the current decomposed the hot concentrated sulphuric acid, separating sulphur. No copper was deposited with the silver, as copper sulphate is very slightly soluble in hot con-

centrated sulphuric acid. In 1873 experiments were made with the same solution, but with anodes of auriferous silver. Pure silver crystals were obtained on the cathode, to which they adhered sufficiently well to be removed from the bath. The anode slime also adhered firmly to the anode. The slime contained all the gold and most of the copper. This process was in operation for some time, during which 2000 kilograms of silver were refined. It was given up, however, on account of a number of practical difficulties, which increased when the process was carried out on a larger scale. One objection was the loss of silver caused by the crystals becoming detached from the cathode before it could be removed from the bath. These fell to the bottom of the tank and became mixed with the slime which also became detached from the anode to a certain extent.

The process now most extensively used for refining silver electrolytically is due to Moebius. There are two processes known by this name, the old and the new. The former uses fixed cathodes, and is in operation at the Deutsche Gold- und Silber-Scheide Anstalt at Frankfurt-am-Main, at the Pennsylvania Lead Company's works near Pittsburg, and at Pinos Altos, Mexico.³ The new process has a rotating cathode and is in operation at the Guggenheim Works at Perth Amboy, New Jersey.⁴

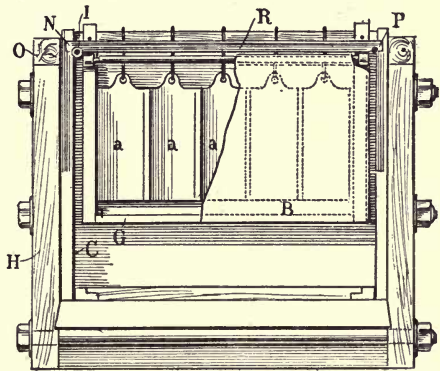

FIG. 21. — Vertical section of the old Moebius apparatus for silver refining, showing anode

The following description of the plant of the Deutsche Gold- und Silber-Scheide Anstalt is condensed from Borchers. The cells are made by dividing a wooden tank 12 feet long and 2 feet wide into 7 equal compartments. The anodes and cathodes

³ Min. Ind. 4, 351, (1895).

⁴ Maynard, Eng. and Min. J. 51, 556, (1891).

are suspended parallel to the ends of the tank, as shown in Figures 21 and 22. The anodes *a* are of such width that five

can be hung side by side across the width of the cell and are from 6 to 10 millimeters thick. The cathodes *k* are thin, rolled sheets of silver that extend across the whole cell. Each contains four cathodes and three rows of anodes. The anodes are inclosed in filter cloth bags for collecting the anode mud. Each cathode has two wooden scrapers *s* on each side to scrape off the silver, which falls into a tray covering the whole area of each cell.

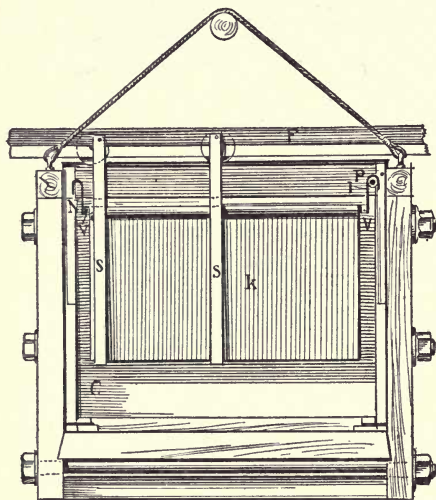

FIG. 22. — Vertical section of the old Moebius apparatus for silver refining, showing cathodes

The bottom of the tray is of filter cloth supported by a wooden grid.

The electrolyte is an acid silver nitrate solution, which soon takes up copper from the anodes as copper nitrate. The concentration of the acid varies from 0.1 per cent to 1 per cent, and the silver concentration amounts to about 0.5 per cent. The copper concentration may be as high as 4 per cent. The current density is largely dependent

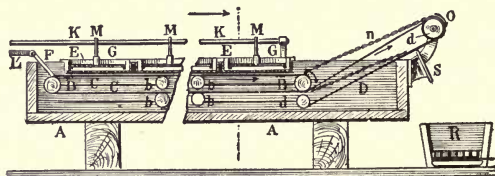

FIG. 23. — Longitudinal section of the new Moebius apparatus for silver refining

on the amount of copper in solution. At first, when not much copper is present, 3 amperes per square decimeter is allowable, but when the concentration increases to 4 per cent, the current density must be reduced to 2 amperes per square decimeter on

account of the danger of depositing copper with the silver. The principle on which the silver is separated from the copper is explained above under electroanalysis. Every twenty-four hours the whole apparatus suspended in the bath is raised out and the silver removed, washed, pressed by hydraulic power, dried, and melted. The anode slime is removed from the bags once or twice a week. In the later form, shown in Figure 23, the tanks are 14 feet 3 inches long, 16 inches wide, and 7 inches deep. An endless sheet of silver *C*, $\frac{1}{32}$ inch thick, moves under the anodes *G* and carries the deposited silver to one end of the tank, where it is carried out of the tank by the belt *D*, and is scraped off by *S*. Electrical contact is made by *F*. The anodes are separated from the cathode by filter cloth, as in the old process.

Gold Refining

The electrolytic refining of gold was first accomplished by Wohlwill¹ at the Norddeutsche Affinerie in Hamburg. The process consists in electrolyzing gold anodes in a hot acid solution of gold chloride. A cyanide solution would not do, because silver and copper would be deposited with the gold. Wohlwill found that gold anodes do not dissolve when electrolyzed in a solution of gold chloride, AuCl_3 , or of chloroauric acid, HAuCl_4 , but that in both cases chlorine is set free. In the solution of chloroauric acid the chlorine may be mixed with oxygen when the current density is low or the solution dilute. In order to have the gold dissolve, there must be some free chloride present, either hydrochloric acid, which is commonly used, or some alkali chloride. At a definite temperature there is a definite amount of free acid for every current density that will prevent the evolution of chlorine. The amount of free acid required decreases with increasing temperature. With a solution containing 3 per cent of hydrochloric acid and 30 grams of gold per liter, at 70° C., as much as 3000 amperes per square meter can be used without liberating chlorine, but in practice as much as 1000 amperes per square meter would hardly ever be used, for other reasons. In case chlorine ap-

¹ Z. f. Elektroch. 4, 379, 402, 421, (1898).

pears at the anode, its evolution can be stopped by adding hydrochloric acid, or by raising the temperature.

The gold is formed on the cathode in large crystalline deposits which adhere in such a way that they can be easily removed mechanically. The more gold in solution, the more compact the deposit, while an increase in the current density has the opposite effect. The impurities coming from the anode also make the gold deposit more compact. With the largest current density allowable for the anode, 30 grams of gold per liter is sufficiently concentrated for precipitating the gold in a convenient form.

The solution of the gold anode shows a certain similarity to that of copper anodes, in that a portion of the gold is dissolved in the monivalent state. This decomposes into trivalent gold chloride and metallic gold, which latter goes into the slimes. This reaction does not take place as rapidly as with copper, however, and the monivalent gold exists through the entire solution and is even deposited at the cathode, causing an increase in the current yield. The higher the current density, the greater will be the potential difference between the anode and the solution, and the larger the proportion of gold that will be oxidized to the trivalent state. This will make the loss in weight of the anode more nearly equal to the gain at the cathode. The following table illustrates this statement. The solution contained 50 cubic centimeters of concentrated hydrochloric acid per liter and was at 65° or 70° C.²

CURRENT DENSITY AMP./SQ. DM.	ANODE LOSS PER AMP. HR. GRM. GOLD	CATHODE GAIN PER AMP. HR. GRM. GOLD
4.4	3.35	3.06
7.4	3.02	2.79
15.0	2.50	2.48

With 15 amperes per square decimeter more hydrochloric acid had to be added to prevent the evolution of chlorine.

² Foerster, Elektrochemie wässriger Lösungen, p. 279.

The impurities³ in the anode may consist of silver, lead, bismuth, and the platinum metals. Silver is converted to silver chloride which drops into the slime or is removed mechanically. Lead is changed to the chloride which dissolves slightly. If present to any considerable extent, it is precipitated by adding sulphuric acid to the solution from time to time. The anode then becomes covered with sulphate, which either drops off itself or is removed mechanically. Bismuth is changed to the oxychloride and is also removed from the anode mechanically. Platinum and palladium both dissolve completely, while the other platinum metals go into the slimes. Platinum can accumulate in the solution till its concentration becomes twice that of the gold, without being precipitated at the cathode, but when the solution contains 5 grams or more of palladium per liter, traces of this metal are found in the gold cathode. The platinum and palladium are allowed to accumulate to this extent and are then recovered. Since only gold is deposited, while other metals are dissolved, the solution, if left to itself, would become poor in gold. This therefore has to be made up by adding gold chloride from time to time.

Besides the platinum metals, the slimes contain one tenth the weight of the gold in the anodes, due to the decomposition of aurous chloride, as explained above. The gold obtained is not infrequently 1000 fine and only in quite exceptional cases is less than 999.8 fine.

At the mint in Philadelphia⁴ the cells are of white porcelain 15 inches long, 11 inches wide, and 8 inches deep. Each cell contains 12 anodes and 13 cathodes, $1\frac{1}{2}$ inches apart, connected in multiple. The anodes are 6 inches long, 3 inches wide, and $\frac{1}{2}$ inch thick. The cathodes are fine gold $\frac{1}{100}$ inch thick.

Electrolysis is also used for precipitating the gold from the very dilute solution obtained in the cyanide process.⁵ The anodes are iron plates 2 to 3 millimeters thick, covered with filter

³ Z. f. Elektroch. 3, 316, (1897). Extract of the German patent, No. 90,276.

⁴ Electrochem. Ind. 1, 157, (1903). For the mint at San Francisco, see *ibid.* 6, 355 and 408, (1908).

⁵ See Cyanid Progresse zur Godgewinnung, by Uslar and Erlwein, Vol. 7, p. 14, of the Engelhardt Monographs; also Borchers, Z. f. Elektroch. 7, 191, (1901).

cloth, and the cathodes are of thin lead foil. The solution used for extraction contains from 0.01 to 0.1 per cent of potassium cyanide. The cells are of iron and are 7 meters long, 1.5 meters wide, and 1 meter deep, divided into several compartments. The electrolyte circulates from one compartment to another. The current density is about 0.5 ampere per square meter at 2 volts.⁵ The gold sticks to the lead cathodes, which are taken out every month and melted with the gold. In some places the iron anodes have been replaced by peroxidized lead and the lead cathodes by tin plate, on which the gold is precipitated as slime.⁶

Lead Refining

Lead is an ideal metal to refine electrolytically, on account of its high electrochemical equivalent and of its relatively high position in the electrolytic series. Its greater tendency to go into solution than that of most of the metals occurring in it as impurities makes it possible to dissolve the lead, leaving the impurities behind in the metallic state. This avoids contaminating the electrolyte, which consequently does not need frequent purification. The principal electrolytic difficulty to overcome was to obtain the lead in a coherent, compact form, from a solution that would not be too expensive to use on a commercial scale. The chloride or sulphate, which are usually the salts employed for metal refining, cannot be used in the case of lead on account of their insolubility. The problem has been solved by A. G. Betts,¹ who found that a solution of lead fluosilicate with a small quantity of gelatine fulfilled the requirements. The fluosilicate solution is not the only one from which a good deposit can be obtained; but it was selected on account of its low price as compared with other solutions giving equally good deposits.² The object in refining lead is to recover the copper, antimony, and bismuth, as well as the gold and silver.

⁶ Electrochem. Ind. 2, 131, (1904).

¹ See Lead Refining by Electrolysis, by A. G. Betts. John Wiley and Sons (1908).

² Betts, *ibid.* p. 17.

The solution of lead fluosilicate (PbSiF_6) is prepared by adding white lead or lead carbonate to fluosilicic acid. Fluosilicic acid is prepared by allowing a solution of hydrofluoric acid, made from sulphuric acid and calcium fluoride, to trickle through a layer of pure sand or broken quartz. Heat is applied to start the reaction, which then furnishes sufficient heat itself to maintain the necessary temperature. No precipitate is formed on adding the lead to the acid unless an excess of lead is added,³ and the solution obtained is colorless. The strength of the solution ordinarily employed in practice is from 6 to 7 grams of lead, and from 12 to 13 grams of SiF_6 per 100 cubic centimeters.⁴ This means about 8 grams of free fluosilicic acid per 100 cubic centimeters of solution. The gelatine is added to the solution as a hot strong solution of glue. Enough is added to make its concentration 0.1 per cent. The temperature of the electrolyte has been found to have no effect in the character of the lead deposit.⁵ In practice about 30° C. is maintained by the current itself.

The impurities in the anode may consist of iron, zinc, sulphur, copper, nickel, tin, antimony, arsenic, bismuth, cadmium, gold, selenium, and tellurium. Only the zinc, iron, nickel, and tin would go into solution. The other metals are all below lead in the electrolytic series and would therefore remain in the anode slime. Zinc, iron, and nickel are above lead and would therefore not be precipitated from the solution with lead. Tin, however, is so near lead in the series that it dissolves and precipitates with the same facility and can therefore not be separated from lead electrolytically. It must be removed by poling, before casting the anodes. When only 0.02 per cent of tin is in the anode, it is found in the cathode.⁶ With this exception, the impurities are easily prevented from reaching the cathode, even when present in the anode in large quantities. Pure lead can be obtained when the anode contains only 65 per cent lead, the rest being impurities of bismuth, antimony, arsenic, silver, and

³ Betts, *l.c.* p. 30. See also Senn, *Z. f. Elektroch.* 11, 230, (1905).

⁴ Betts, *l.c.* p. 255.

⁵ Senn, *l.c.*

⁶ Betts, *l.c.* p. 46.

copper.⁷ A low current density, — 4 amperes per square foot, — was required with anodes of this composition.

The slime nearly all adheres to the anode and is consequently easily removed from the bath. Its composition of course depends on that of the anodes. It has been stated that the handling of the anode slime has not been satisfactorily settled,⁸ and from the large amount of space given to this subject by Betts in his book, it would seem to be an unusually difficult problem. The method employed at Trail, British Columbia, by the Consolidated Mining and Smelting Company of Canada, consists in treating the slime with sodium sulphide, which extracts 80 per cent of the antimony and some arsenic. The antimony is then deposited electrolytically on steel cathodes using lead anodes.

The cathodes used in lead refining are thin sheets of pure lead. The current density allowable depends on the purity of the anodes. As stated above, anodes containing only 65 per cent lead can be refined if the current density is as low as 4 amperes per square foot. In practice the anodes are about 98 per cent pure,⁹ and the current density is from 12 to 16 amperes per square foot. The analysis of refined lead from Trail shows a purity of about 99.995 per cent. The average voltage per tank is from 0.30 to 0.38 volt and the polarization amounts to 0.02 volt. The tanks, made of southern yellow pine, are arranged in the multiple system. The electrolyte is caused to circulate by having the difference in the level of two successive tanks from $2\frac{1}{2}$ to 3 inches. Five gallons per minute is a fair amount of circulation for a 4000 ampere tank.

Lead is refined electrolytically at Trail, British Columbia, New Castle on Tyne, England, and by the United States Metals Refining Company at Grasselli, Indiana. The capacity of the first plant in 1908 was about 80 tons a day, of the third 85 tons. A detailed description of the plants at Trail and Grasselli will be found in Betts's treatise, referred to above.

⁷ Betts, *l.c.* p. 56.

⁸ *Min. Ind.* 15, 545, (1906).

⁹ For the following statements, see Betts, *l.c.* p. 287, Table 110 ; p. 255, Table 91 ; p. 287, Table 108, and p. 189, Table 73.

Zinc Refining

It is possible to refine zinc electrolytically, but commercial zinc contains no metals that it would pay to recover, and the demand for very pure zinc is limited.

The only impurities occurring in commercial zinc are iron, lead, and cadmium. In the slightly acid chloride solution, containing about 56 grams of zinc per liter, with a current density of 1.8 to 1.9 amperes per square decimeter, zinc can be freed from its impurities to as great an extent as copper. The analysis of some refined zinc is as follows: ¹

99.955	per cent zinc,
0.036	per cent lead,
0.0012	per cent iron,
0.0080	per cent cadmium.

Though the refining of commercial zinc electrolytically is seldom carried out, certain alloys of zinc rich in silver, obtained in other metallurgical processes, have been successfully refined on a commercial scale at Tarnowitz in Silesia.² When lead containing silver is treated with zinc, most of the silver is taken up by the zinc, forming an alloy which floats on the lead. This zinc scum, containing the silver, is cast into anodes one centimeter thick, weighing from 20 to 30 kilograms, which are electrolyzed in a solution of zinc sulphate. The composition of the anodes is the following:

Silver	11.32 per cent
Lead	3.13 per cent
Copper	6.16 per cent
Nickel	0.51 per cent
Iron	0.24 per cent
Zinc	78.64 per cent
Antimony, arsenic, bismuth, traces.	

The current density is 80 to 90 amperes per square meter, requiring 1.25 to 1.45 volts. The purity of the resulting zinc is not given.

¹ Foerster and Günther, *Z. f. Elektroch.* 5, 16, (1898), and 6, 301, (1899).

² Hasse, *Z. f. Berg- Hütten- und Salinenwesen*, 45, 322, (1897).

CHAPTER V

ELECTROLYTIC REDUCTION AND OXIDATION

1. REDUCTION

REDUCTION is a term now applied to several really different processes. It may mean the loss of a positive electric charge by an ion, as when ferric ion changes to ferrous, or the acquiring a negative charge, as when chlorine changes to a chlorine ion, or it may mean the direct addition of hydrogen or the removal of oxygen from a molecule. All of these different kinds of reduction may be produced electrolytically by bringing the substances to be reduced in contact with a cathode. Of course the reduction resulting from the addition of hydrogen is dependent on the deposition of hydrogen on the cathode, which reacts while in the nascent state with the reducible substance with which it comes in contact. The loss of positive charge may also be represented as being produced by the hydrogen liberated on the cathode, while in the nascent state, as illustrated by the equation :

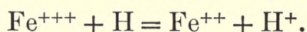

Reduction by acquiring a negative charge is illustrated by the chlorine electrode, made by saturating a platinum electrode with chlorine. When chlorine changes from the molecular to the ionic state on a chlorine electrode, the positive current flows from the solution to the electrode and molecular chlorine takes a negative charge :

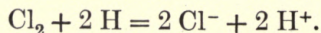

Molecular hydrogen has very little reducing power, and consequently the reducing power of a cathode must be ascribed to the hydrogen liberated on it while in the nascent state. According to the mass action law, the reducing power of nascent hydrogen is proportional to its concentration. The potential difference between the cathode and the solution is also dependent on the concentration of the nascent hydrogen, as can be shown as follows: The potential of the hydrogen electrode is given by the equation¹

$$e = RT \log \frac{P_{H_2}}{p_{H^+}}, \quad (1)$$

where P_{H_2} is the electrolytic solution pressure, and p_{H^+} the osmotic pressure, of the hydrogen ions in solution. But $P_{H_2}^2 = k_1 p$, in which k_1 is a constant and p is the pressure of the gaseous hydrogen in contact with the electrode and solution.² By Henry's Law, p must be proportional to the concentration c_{H_2} of the molecular hydrogen in the solution immediately on the electrode. The concentration of the molecular hydrogen must in turn be proportional to the square of the concentration of the nascent hydrogen on the electrode, since the reaction is $2H = H_2$, and by the mass action law, for equilibrium,

$$(c_H)^2 = k_2 c_{H_2}.$$

The electrolytic solution pressure is therefore proportional to the concentration of the nascent hydrogen on the cathode, since, as explained above,

$$P_{H_2}^2 = k_1 p = k_2 c_{H_2} = k_3 c_H^2.$$

Obviously, any of the quantities proportional to $P_{H_2}^2$ may be substituted in equation (1). Substituting $k_3 c_H$,

$$e = RT \log \frac{(k_3)^{\frac{1}{2}} c_H}{c_{H^+}} \quad (2)$$

which shows that the potential of the cathode is a measure of its reducing power, since it is determined by the concentration of

¹ Le Blanc, *Electrochemistry*, p. 183, (1907).

² Le Blanc, *Electrochemistry*, p. 195, (1907).

the nascent hydrogen, c_H , assuming c_{H^+} , the concentration of hydrogen ions, is constant.

If the cathode potential is to be expressed in terms of the pressure of the hydrogen gas in contact with it and the solution, it may be done by transforming equation (1) and substituting as follows:

$$e = RT \log \frac{P_{H_2}}{p_{H^+}} = \frac{RT}{2} \log \frac{P_{H_2}^2}{(p_{H^+})^2} = \frac{RT}{2} \log \frac{k_1 p_{H_2}}{(p_{H^+})^2} \quad (3)$$

These equations give only the numerical value of the potential difference between the electrode and the solution, and take no account of which is positively and which is negatively charged. The charge on any electrode whose potential can be represented by a formula similar to those above may be either positive or negative, depending on whether the value of the fraction following the logarithm sign is greater or less than one.

The two principal advantages of electrolytic reduction, over that produced by adding some chemical reducing agent, which must of course be oxidized itself, is that no such oxidized substance is left in the solution, and that the reducing power of a cathode can be varied within wide limits and in small steps. One method of varying the reducing power of the cathode is to vary the current density on it. The increase in the potential difference that can be obtained in this way, however, is not very great. This is shown in Table 7, in which are given the current densities and the corresponding potentials referred to the normal hydrogen electrode as zero, of cathodes of different metals dipping in twice normal sulphuric acid:³ It will be

TABLE 7

AMPERES PER SQUARE CM.	MERCURY	TIN	GOLD	COPPER	NICKEL	PLATINIZED PLATINUM
0.01	1.19	0.97	0.74	0.57	0.56	0.05
0.05	1.26	1.11	0.89	0.70	0.67	0.06
0.11	1.30	1.16	0.95	0.77	0.73	0.08
0.15	1.32	1.18	1.09	0.82	0.76	0.09

³ Tafel, Z. f. phys. Ch. 50, 710, (1905).

seen that the potential difference between electrode and solution does not increase much with increasing current density, but that for a given current density it is quite different for different metals. This is due to what has been called the over-voltage for the metal in question, which means the excess voltage necessary to liberate a gas on the metal over that necessary to liberate it on a reversible electrode.⁴ The reducing power of a cathode can therefore be greatly varied by making the cathode of different metals.

This change in reducing power may be made to appear in much larger numerical values by calculating the number of atmospheres to which these higher potentials, due to overvoltage, correspond; that is, by assuming that the higher potentials are produced by compressing the gaseous hydrogen surrounding a reversible electrode, and computing the number of atmospheres pressure that would be necessary to make the potential difference between electrode and solution some definite amount, 0.1 volt, for example. This can be done by writing the expression for the electromotive force of the cell:

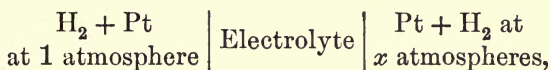

and placing it equal to 0.1 volt. The electromotive force of this cell by (3) is then:

$$0.1 = \frac{RT}{2} \left[\log \frac{x}{p_{\text{H}^+}{}^2} - \log \frac{1}{p_{\text{H}^+}{}^2} \right] = \frac{RT}{2} \log \frac{x}{1} = \frac{0.058}{2} \log_{10} x.$$

Solving this equation for x gives 2800 atmospheres. For 0.2 volt the value of x is 8 million atmospheres. This is the meaning of the statement frequently met with,⁵ that the pressure of the hydrogen evolved by electrolysis can be increased to millions of atmospheres. The values thus calculated, however, can hardly represent the physical state of the gas evolved on a cathode.

Another important factor in electrolytic reduction is the

⁴ Le Blanc, *Electrochemistry*, p. 287, (1907).

⁵ Nernst, *Theoretische Chemie*, 6th ed. p. 756, (1909).

catalytic effect of the metal composing the cathode. As a result of this effect a substance may be more easily reduced on one cathode than another, even though the overpressure is the same for both cathodes.⁶

The electrolytic reduction of galena, or lead sulphide, in a sulphuric acid solution was carried out for a while on a large scale at Niagara Falls, but had to be given up eventually on account of the poisonous effect of the hydrogen sulphide produced.

The galena, which had been ground to pass a 40 to 50 mesh sieve, was spread in a layer $\frac{1}{2}$ inch thick and covered with dilute sulphuric acid.⁷ The current density was 30 amperes per square foot, and the current efficiency was about 66 per cent.⁸ About 97 per cent of the lead sulphide was reduced to spongy lead, which was washed free of sulphuric acid, and converted into litharge by roasting.

In case the substance to be reduced is in solution, it must be prevented from coming in contact with the anode, where it would be oxidized again. This is accomplished by separating the anode from the cathode compartment by some kind of diaphragm, such as porous clay, that allows the electrolytic passage of the current, but which prevents the mechanical mixture of the liquids in the two compartments. An example of this kind is the production of chromic sulphate from chromic sulphate. The solution contains 500 grams of chromic sulphate in 500 cubic centimeters of concentrated sulphuric acid, and is electrolyzed on a lead cathode with 0.1 to 0.15 ampere per square centimeter. The blue-green chromous sulphate deposits on the cathode, as the solution about the cathode becomes saturated with it.⁹

⁶ Foerster, *Elektrochemie wässriger Lösungen*, p. 315, (1905).

⁷ Salom, *Trans. Am. Electrochem. Soc.* **1**, 87, (1902).

⁸ Salom, *Trans. Am. Electrochem. Soc.* **4**, 101, (1903).

⁹ Foerster, *Elektrochemie wässriger Lösungen*, p. 319, (1905).

2. OXIDATION

The oxidizing power of an anode is related to the potential difference between the electrode and the solution in the same way as the reducing power of a cathode and the potential difference between it and the solution. There is also an over-pressure for oxygen on different metals, as in the case of hydrogen.¹ The results of the following table were obtained in a normal solution of potassium hydrate. The potential differences given between anode and solution were measured when oxygen first appeared on the anode against a hydrogen electrode in the same solution.

TABLE 8

Potential Difference between Anode and Solution when Oxygen first Appears

METAL	POTENTIAL
Gold	1.75
Platinum, smooth	1.67
Palladium	1.65
Cadmium	1.65
Silver	1.63
Lead	1.53
Copper	1.48
Iron	1.47
Platinized platinum	1.47
Cobalt	1.36
Nickel, smooth	1.35
Nickel, spongy	1.28

The number of metals that can be used as anode is much less than those that can be used as cathode, and is limited to those metals that would not be dissolved by an action of the current. Platinum, lead, and carbon are the principal materials for un-attackable anodes in acid solutions, while besides these both nickel and iron may be used in alkaline solutions.

Coehn and Osaka also found a decomposition point of 1.1 volts for all of the metals investigated, which they identified

¹ Coehn and Osaka, *Z. f. anorg. Ch.* **34**, 86, (1903).

with the value of the hydrogen-oxygen cell, then thought to be 1.06 volts. The true value of this cell, however, has since been found to be 1.22 volts,² so that their first point cannot have this significance. The overvoltage of a spongy nickel electrode is evidently very small, for its value in the above table is only a little greater than 1.22 volts, the true potential of an oxygen electrode, assuming a hydrogen electrode in the same solution equal to zero.

There is also a catalytic effect of the anode material on oxidation, which may be of more practical importance than the overpressure. For example, the yield in oxidizing iodic to periodic acid on smooth platinum was found to be 1 per cent, on platinized platinum 3 per cent, and on lead peroxide 100 per cent, though the potential differences between the anodes and the solution were 1.72, 1.48, and 1.52 volts respectively.³ In the oxidation of chromium sulphate, described below, smooth platinum anodes give practically no yield of chromate, while with lead peroxide anodes current yields between 20 and 97 per cent are obtained, depending on the concentration of the chromium sulphate, though the overpressure of oxygen on the peroxide is only a few hundredths of a volt higher than on platinum.⁴

The following are some of the most important technical applications of electrolytic oxidation.

In dye works, solutions of sodium or potassium bichromate and sulphuric acid are used for oxidizing anthracene to anthraquinone:

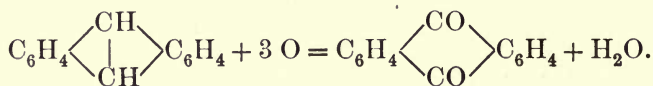

The bichromate is thereby reduced to chromium sulphate and must be regenerated before it can be used again. Formerly this was accomplished by precipitating with calcium hydrate

² Nernst, *Z. f. Elektroch.* **11**, 835, (1905); Haber, *ibid.* 834; Lewis, *Journ. Am. Chem. Soc.* **28**, 185, (1906).

³ Müller, *Z. f. Elektroch.* **10**, 61, and 62, (1904).

⁴ Müller and Soller, *Z. f. Elektroch.* **11**, 863, (1905).

and heating the resulting pasty material, consisting of chromium oxide, calcium hydrate, and calcium sulphate, to red heat. This treatment produces calcium chromate, which, when treated with sodium sulphate, gives sodium chromate and calcium sulphate. On removing the insoluble calcium sulphate the sodium chromate can be used for oxidation. This method is uneconomical on account of the loss of sulphuric acid and of chromium which it involves, and it has been superseded by the electrolytic process patented in 1898 by the *Farbwerke vorm. Meister, Lucius, und Brunig*.⁵ This process consists in oxidizing on a lead peroxide anode a solution of chromium sulphate containing free sulphuric acid, in the anode compartment of a lead-lined electrolytic cell. The anode and cathode compartments are separated by a diaphragm. The chromium is oxidized from a cation to an anion in changing from a chromium salt to a chromate, and at the same time sulphuric acid concentrates in the anode compartment, due to the migration of the sulphate ions. After using the anode liquid for oxidation, it is first placed in the cathode compartment, where the sulphuric acid concentration decreases, after which it is again oxidized.

It is very difficult to construct diaphragms of size great enough for technical use that can resist the action of the chromic acid produced. *Le Blanc*,⁶ after a number of experiments, produced diaphragms consisting of 25 per cent alumina and 75 per cent silica, which he considered satisfactory at the time, but it seems eventually not to have been successful, for he has since patented a process for this oxidation in which the two compartments are separated by a partition reaching not quite to the bottom of the cell, in place of a conducting diaphragm.⁷ The liquid is circulated from the cathode to the anode compartment.

Another example of technical oxidation is the production of insoluble salts and oxides of metal by a process patented in 1894 by *C. Luckow*.⁸ The difficulty encountered in the electro-

⁵ *Z. f. Elektroch.* **6**, 256, (1899).

⁶ *Z. f. Elektroch.* **7**, 290, (1905).

⁷ *Z. f. Elektroch.* **13**, 791, (1907); **14**, 12, (1908).

⁸ *Borchers, Z. f. Elektroch.* **3**, 482, (1897).

lytic manufacture of insoluble salts or other compounds by the oxidation of the metallic anode is that the compound sticks to the anode and produces a high electrical resistance. In the Luckow process this difficulty is overcome by using a 1½ per cent solution of a mixture of two salts, the anion of one forming a soluble salt with the metal of the anode, and the anion of the other forming the insoluble salt desired. The mixture consists of 80 parts of the first, or auxiliary salt, to 20 parts of the second, or principal salt. The anions of the principal salt, being present in a much smaller number than those of the auxiliary salt, are soon used up in the layer of solution next to the anode, and are replaced slowly because the auxiliary anions carry most of the current on account of their greater number. The ions of the anode, on dissolving, do not, therefore, come in contact with the anions of the principal salt directly on the anode, but the precipitate is formed a slight distance from the anode and therefore does not stick, but falls down to the bottom of the cell.⁹

If the auxiliary salt is not added, the salt desired cannot be produced with a satisfactory yield, for either the anode is covered with an insulating layer of the insoluble salt, or the desired salt is not produced at all. For example, in electrolyzing a lead anode in a 0.12 per cent solution of potassium chromate, a mixture of lead peroxide and lead chromate formed on the anode, but practically no yield of lead chromate could be obtained.¹⁰ Even when the two salts are in the right proportion, if the solution is too concentrated, the same difficulties are encountered.

In manufacturing white lead, for which the Luckow process seems well suited, a 1½ per cent solution of a mixture of 80 per cent sodium chlorate and 20 per cent sodium carbonate is electrolyzed with a soft lead anode and a hard lead cathode, with a current density of 0.5 ampere per square decimeter. Carbon dioxide is passed through the solution over the anode to replace that removed by the lead. If enough of the gas is passed

⁹ Le Blanc and Bindschedler, *Z. f. Elektroch.* **8**, 262, (1902).

¹⁰ Isenburg, *Z. f. Elektroch.* **9**, 275, (1903).

through the solution, the pure carbonate of lead is produced, and in order to get basic carbonate the quantity of carbonic acid must be limited. The same result can be accomplished by diluting the carbonic acid with an indifferent gas, such as air, and passing an excess through the solution. Table 9 shows the relation between the concentration of the gas and the product :¹⁰

TABLE 9

RATIO OF AIR TO CO ₂ BY VOLUME	PER CENT PbO IN PRODUCT	PER CENT PbO IN WHITE LEAD 2 PbCO ₃ · Pb(OH) ₂
97 : 3	86.50	86.31
80 : 20	85.92	86.31
60 : 40	83.41	86.31

It is evident that the carbon dioxide is too concentrated when mixed with air in the proportion of 40 to 60.

In producing oxides by this metal, the mixture of salt electrolyzed contains only 0.5 per cent of the auxiliary salt. For lead peroxide, a 1½ per cent solution of a salt mixture consisting of 99.5 per cent of sodium sulphate and 0.5 per cent of sodium chlorate, acidified with sulphuric acid, is used. The current density on the anode is about 0.2 ampere per square decimeter.

The electrolytic method of producing iodoform has almost entirely displaced the older chemical method. The electrolytic method was patented as early as 1884 by the Chemische Fabrik auf Aktien, vorm. E. Schering.¹¹ According to this patent, iodoform is made by electrolyzing a hot solution of potassium iodide and alcohol, through which carbon dioxide is passed. The addition of alkali carbonate also was found advantageous, when the study of this subject was taken up.¹¹ The final result of the chemical reaction of iodine on alcohol in the presence of alkali carbonate is represented by the equation :

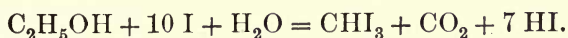

¹¹ Elbs and Herz, Z. f. Elektroch. 4, 113, (1897).

The iodine may be furnished by liberating it electrolytically from potassium iodide on a platinum anode. This is an oxidation, since the iodine ion is deprived of a negative charge. A suitable solution for this electrolysis is made up of 5 grams of sodium carbonate, 10 grams of potassium iodide, 20 cubic centimeters of alcohol, and 100 cubic centimeters of water.

The iodine does not act on the alcohol directly, as given by the above equation, but first forms alkali hypoiodite with the hydroxyl ions from the hydrolysis of the carbonate according to the equation :

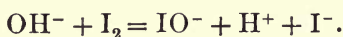

The hypoiodite is hydrolytically dissociated as follows :

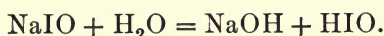

Hypoiodous acid, being unstable, decomposes in the following two ways :¹²

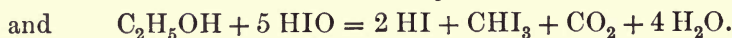

That iodine does not act directly on alcohol was proved by determining the decomposition point of the solution with and without the addition of alcohol. If the alcohol combined directly with the iodine liberated, it would reduce the concentration of the free iodine on the electrode and lower the decomposition point. Since the potential of an iodine electrode is¹³

$$e = \frac{RT}{2} \log \frac{KC_{\text{I}_2}}{(C_{\text{I}^-})^2},$$

in which C_{I_2} is the concentration of the free iodine and C_{I^-} is that of the iodine ions, any substance in solution which reduces the value of C_{I_2} will change the numerical value of the potential. It was found that alcohol has not such depolarizing effect, but that the carbonate has, which fact points to the explanation given above.

¹² Dony-Hénault, Z. f. Elektroch. 7, 57, (1900).

¹³ Foerster, Elektrochemie wässriger Lösungen, p. 124, (1905).

A high current density decreases the yield, since a greater concentration of alkali hypiodite tends to produce a larger amount of iodate. With a solution made up of 10 grams of alcohol, 5 grams of sodium carbonate, 16 grams of potassium iodide, and 100 grams of water, Foerster and Meves obtained the following results: ¹⁴

AMPERES PER SQUARE DECIMETER	CURRENT YIELD IN PER CENT OF THE THEORETICAL
1	95-97
2	80-93
3	73-79

Since iodine is continuously removed from the solution, and carbon dioxide is added, the alkali carbonate will increase in concentration. When it had increased to six times the amount given in the formula just above, the yield fell to 43 per cent, with a current density of 2 amperes per square decimeter, and the iodoform formed in a thick crust on the anode and contained free iodine. The carbonate should therefore not be allowed to accumulate to this extent.

Bromoform and chloroform cannot be produced in this way, but other oxidation products are formed, especially chlor- or brom- aldehyde. This is due to the higher potential at which bromine and chlorine are liberated, which is sufficient to oxidize the alcohol. Bromoform can be produced with a good yield, however, if acetone is used in place of alcohol.

¹⁴ Z. f. Elektroch. 4, 268, (1897).

CHAPTER VI

THE ELECTROLYSIS OF ALKALI CHLORIDES

1. THEORETICAL DISCUSSION

The Chemical Action of Chlorine on Water and Alkali Hydrate

THE electrolysis of sodium and potassium chlorides is one of the largest electrochemical industries that is carried out in aqueous solution. Chlorine and sodium hydrate, hypochlorite, chlorate, or perchlorate may be produced from sodium chloride, depending on the conditions of the electrolysis.

The first products obtained on electrolyzing the solution of an alkali chloride are chlorine at the anode and alkali hydrate at the cathode. If these two primary products are the ones desired, they must not be allowed to mix, while if hyperchlorite, chlorate, or perchlorate is desired, the chlorine and hydrate must be allowed to react with each other. Before describing the electrolysis of the alkali chlorides, it will be necessary to give a brief account of the purely chemical reactions that take place between chlorine and the alkali hydrates, and between chlorine and pure water.

Chlorine enters into a reaction with pure water to a slight extent, according to the equilibrium represented by the equation:¹

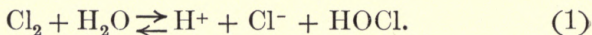

The equilibrium constant of this reaction is

$$K_1 = \frac{C_{\text{Cl}_2}}{C_{\text{H}^+} \cdot C_{\text{Cl}^-} \cdot C_{\text{HOCl}}} = 2570,$$

¹ Jakowkin, Z. f. phys. Ch. 29, 613, (1899).

if the concentrations are taken in moles per liter.² It is evident from the large value of this constant, and from the fact that the concentration of free chlorine in a saturated solution at 25° is only 0.064 mole per liter,³ that the concentration of hydrochloric and hypochlorous acids that can exist together in solution are very small. If brought together in greater concentrations, chlorine will be produced, according to equation (1), taken from right to left.

If chlorine is passed into a solution of alkali hydrate, the following reaction between the chlorine and hydroxyl ions takes place:

$$\text{Cl}_2 + \text{OH}^- \rightleftharpoons \text{HOCl} + \text{Cl}^- \quad (2)$$

The value of the equilibrium constant of this equilibrium is given by the following equation:⁴

$$K_2 = \frac{C_{\text{Cl}_2} \cdot C_{\text{OH}^-}}{C_{\text{Cl}^-} \cdot C_{\text{HOCl}}} = 3.6 \times 10^{-11}, \quad (3)$$

which is derived from the equations

$$\frac{C_{\text{Cl}_2}}{C_{\text{H}^+} \cdot C_{\text{Cl}^-} \cdot C_{\text{HOCl}}} = 2570 \quad \text{and} \quad C_{\text{H}^+} = \frac{K_w}{C_{\text{OH}^-}} = \frac{1.4 \times 10^{-14}}{C_{\text{OH}^-}}$$

In all of these equations the concentrations are in moles per liter. Hypochlorous acid then reacts with the unchanged hydrate to produce a hypochlorite, and this reaction also leads to an equilibrium represented by the equation:

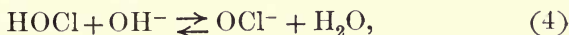

for which the equilibrium constant is

$$K_3 = \frac{C_{\text{HOCl}} \cdot C_{\text{OH}^-}}{C_{\text{OCl}^-}}$$

This is the hydrolysis constant of the hypochlorite. The value of K_3 can be obtained from the dissociation constant of hypochlorous acid:⁵

$$K_4 = \frac{C_{\text{OCl}^-} \cdot C_{\text{H}^+}}{C_{\text{HOCl}}} = 3.7 \times 10^{-8},$$

² Luther, Z. f. Elektroch. 8, 602, (1902).

³ Foerster, Elektrochemie wässeriger Lösungen, p. 341, (1905).

⁴ Foerster and Müller, Z. f. Elektroch. 8, 921, (1902). The value of K_w is taken from van Laar, Theoretische Elektrochemie, p. 174, (1907).

⁵ Sand, Z. f. phys. Ch. 48, 610, (1904).

and the dissociation constant of water:

$$K_w = C_{H^+} \cdot C_{OH^-} = 1.4 \times 10^{-14}.$$

Dividing K_w by K_4 ,

$$\frac{K_w}{K_4} = \frac{C_{H^+} \cdot C_{OH^-} \cdot C_{HOCl}}{C_{OCl^-} \cdot C_{H^+}} = K_3 = \frac{1.4 \times 10^{-14}}{3.7 \times 10^{-8}} = 3.8 \times 10^{-7}.$$

When therefore any quantity of chlorine acts on alkali hydrate, the resulting quantities of hydrate, chlorine, chloride, hypochlorous acid, and hypochlorite are determined by the equilibria represented by equations (2) and (4). Only when there are at least two equivalents of hydrate to one mole of chlorine does the following reaction hold :

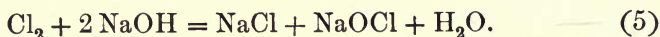

This is the sum of equations (2) and (4), and is the one usually given to represent the reaction between chlorine and hydrate. Since the equilibria represented by equation (3) and the equation for the value of K_3 exist simultaneously, the values of C_{OH^-} and C_{HOCl} are the same in both. From the equation for K_3 ,

$$\frac{C_{HOCl}}{C_{OH^-}} = K_3 \cdot \frac{C_{OCl^-}}{C_{OH^-}^2},$$

and combining this with the equation for K_2 ,

$$\frac{C_{Cl_2}}{C_{Cl^-}} = K_2 \cdot \frac{C_{HOCl}}{C_{OH^-}} = K_2 K_3 \frac{C_{OCl^-}}{C_{OH^-}^2}. \quad (6)$$

This equation is convenient for predicting what effect a change in the concentration of one substance will have on that of the others.

From equation (6) it would seem that for a given value of C_{Cl_2} and C_{Cl^-} , the value of C_{OCl^-} could be increased in proportion to the value of C_{OH^-} . This would be true, if the concentration of the hypochlorite, C_{OCl^-} , were not limited by another reaction,—the oxidation of hypochlorite to chlorate by hypochlorous acid, according to the equation:⁶

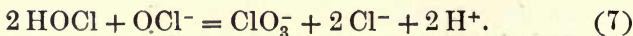

⁶ Foerster and Jorre, *J. f. prakt. Ch.* 59, 53, (1899); Foerster, *ibid.* 63, 141, (1901).

The free hydrochloric acid then sets free an equivalent amount of hypochlorous acid according to the equation :



and the hypochlorous acid thus set free oxidizes more hypochlorite. This process continues until all of the hypochlorite has been changed to chlorate.

Substituting the numerical values of K_2 and K_3 in (6), we have

$$\frac{C_{\text{Cl}_2}}{C_{\text{Cl}^-}} = 3.6 \times 10^{-11} \frac{C_{\text{HOCl}}}{C_{\text{OH}^-}} = 1.4 \times 10^{-17} \frac{C_{\text{ClO}_2^-}}{C_{\text{OH}^-}^2}. \quad (9)$$

In order to illustrate the use of the above equation, the relative concentrations of chlorine ions, hydroxyl ions, free chlorine, and hypochlorous acid in a neutral solution normal with respect to hypochlorite ions will be calculated. From the value of K_3 , the values of C_{HOCl} and C_{OH^-} are each $6.2 \cdot 10^{-4}$ mole per liter, and from (9) the value of the fraction $\frac{C_{\text{Cl}_2}}{C_{\text{Cl}^-}}$ is 3.6×10^{-11} . If the concentration of chlorine ions is also normal, that of the free chlorine is only 3.6×10^{-11} mole per liter.⁴

If chlorine is led into a solution of alkali hydrate, nothing but hypochlorite and chloride are produced as long as some of the hydrate remains unneutralized. This is because the excess of hydroxyl ions drives back the hydrolysis of the hypochlorite and therefore prevents the formation of a free hypochlorous acid. When an amount of chlorine equivalent to the hydrate has been added, there is still so small a quantity of free hypochlorous acid present that the solution is fairly stable. An excess of chlorine, however, increases the concentration of the free hypochlorous acid to such an extent that the hypochlorite is rapidly oxidized to chlorate, according to equation (7). The fact that an excess of chlorine was necessary to produce chlorate was first discovered by Gay-Lussac.⁷ The addition of a small quantity of free acid would have the same effect as an excess of chlorine, for it would set free hypochlorous acid.

⁷ Liebig Ann. 43, 153, (1842).

If chlorate were formed only by means of free hypochlorous acid, hypochlorite would be more stable the greater the excess of hydroxyl ions in the solution. Chlorate is produced, however, slowly in alkaline solutions, presumably by the reaction

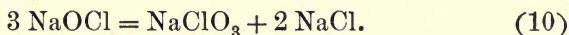

Hypochlorous acid breaks up in exactly the same way, when it decomposes of itself. The solution has to be heated to 70°C . to make this reaction proceed with an appreciable velocity,⁶ and it is also catalyzed by light. With increasing alkalinity the velocity of the reaction increases somewhat, and it is always accompanied by the reaction:



The last reaction is catalyzed by some metallic oxides, especially by the oxide of cobalt, to such an extent that all of the hypochlorite can be decomposed in this way without forming any chlorate.⁶

Perchlorate cannot be formed by the further action of chlorine on chlorate, but is produced by the decomposition of chlorate, as will be explained below.

The Electrolysis of Alkali Chloride on Smooth Platinum Electrodes without a Diaphragm

If a concentrated neutral solution of alkali chloride is electrolyzed between smooth platinum electrodes, the alkali is deposited on the cathode and reacts with the water according to the equation:



The hydrogen produced escapes, unless it is used up in reducing some substance in the solution. On the anode, chlorine is liberated from the ionic form to free chlorine, as follows:



The liberated chlorine partly dissolves in the water and at first partially escapes from the solution. Soon, however, the alkali hydrate produced at the cathode and the dissolved

chlorine are brought together by the stirring produced by the escaping hydrogen, and after this no more chlorine escapes from the solution. Chlorine and alkali hydrate are produced in equivalent quantities, so that the equation (5),



is practically quantitative. It is evident that only 50 per cent of the chlorine liberated is obtained in the active form as hypochlorite. As the electrolysis proceeds, the hypochlorite becomes more and more concentrated, until finally a limiting concentration is reached, whose value is determined by a number of factors, such as the material of the anode, the current densities on the anode and cathode, the temperature, and the original concentration of the chloride solution. This is due to the fact that the hypochlorite, almost from the start, is also decomposed by the current, and this decomposition increases as the concentration of the hypochlorite increases, until the amount decomposed is just equal to the amount produced. This decomposition takes place in two ways; at the cathode the hypochlorite is reduced by the hydrogen as follows:

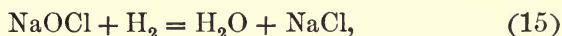

and at the anode the hypochlorite ion is liberated, since it is more easily discharged than the chlorine ion,¹ and reacts with the water, producing chlorate and oxygen according to the following reaction:²

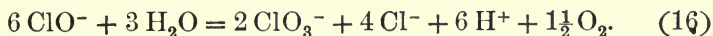

This has been called the anode chlorate formation, since it takes place only on the anode and not throughout the solution.

It may help in understanding the chloride electrolysis if, before discussing it further, a method of analysis is explained which has been extensively used in the study of this subject for following the reactions taking place during the electrolysis.

¹ Foerster and Müller, *Z. f. Elektroch.* **8**, 634, (1902).

² Foerster and Müller, *Z. f. Elektroch.* **8**, 667, (1902). This equation is considered fairly well established, as will be shown below, though other explanations of the results are possible.

This consists in analyzing the gas evolved from the cell and comparing the amount of hydrogen and oxygen in it with that evolved by the same current from a water coulometer.³ If there is less hydrogen from the chloride cell than from the coulometer, the difference must have been used in reducing the hypochlorite, according to equation (15), as this is the only reducible substance in solution. The oxygen in the gas evolved from the cell containing the chloride solution must be due to the discharge of the hypochlorite ion, which reacts with the water according to equation (16), producing chlorate and oxygen. Oettel believed that the reaction was simply the evolution of oxygen according to the equation :

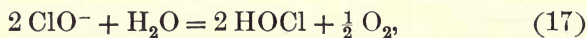

and he therefore called this portion of the current loss "water decomposition," but this view has since been found to be incorrect. Since the proportion of oxygen evolved to the hypochlorite ions discharged is the same in either case, Oettel's calculations will not be changed, but the explanation of the oxygen evolution will be given by equation (16) in place of (17). According to equation (17), the oxygen evolved is proportional simply to a current loss without destroying hypochlorite already formed, while according to (16) it is proportional to a fraction of the current that changes hypochlorite to chlorate.

The following example, illustrating the use of gas analysis for determining the yield in hypochlorite as the electrolysis progresses, is taken from Oettel.³

The cell containing the chloride solution was connected in series with a water coulometer. During a given time, at the beginning of the electrolysis, 60 cubic centimeters of gas were evolved from the coulometer and 32 cubic centimeters from the chloride solution. In the coulometer, 40 cubic centimeters of the gas must have been hydrogen. By analysis it was found that the gas from the chloride solution had the following composition: 30 cubic centimeters of hydrogen, 1.6 of oxygen, and 0.4 of chlorine. This shows a difference in the amount of hy-

³ F. Oettel, *Z. f. Elektroch.* 1, 354, (1894).

drogen in the two cells of 10 cubic centimeters. This amount must therefore have been used to reduce the hypochlorite already formed. Since 40 cubic centimeters of hydrogen represents the total current, or 100 per cent, the loss of current due to reduction was $100 \times \frac{10}{40} = 25$ per cent. The loss due to the evolution of chlorine equals $100 \times \frac{0.4}{40}$, or 1 per cent. The 1.6 cubic centimeters of oxygen are equivalent to twice as much hydrogen, or 3.2 cubic centimeters. The loss of current by changing hypochlorite to chlorate was therefore $100 \times \frac{3.2}{40} = 8$ per cent. The current used to produce hypochlorite is proportional to the amount of hydrogen evolved from the chloride solution, diminished by the quantity of chlorine evolved, and twice the amount of oxygen: $30 - (3.2 + 0.4) = 26.4$ cubic centimeters. The current yield is therefore $100 \times \frac{26.4}{40} = 66$ per cent. This, of course, means that 66 per cent of the current produces hypochlorite according to equation (5):

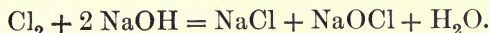

The rest of the current destroys hypochlorite already produced, or produces chlorine which escapes from the cell. Chlorine is evolved, however, only at the very beginning of the electrolysis, before the hydrate and chlorine have had time to mix. The following table sums up the results of this calculation:

Current used to produce hypochlorite	66 per cent
Current used to reduce hypochlorite	25 per cent
Current loss by changing hypochlorite to chlorate	8 per cent
Current loss due to evolution of chlorine	1 per cent
	100 per cent

The curves in Figure 24⁴ will illustrate the results of the electrolysis of a neutral 4.37 normal sodium chloride solution with a current density on the anode of 0.075 ampere per square centimeter and on the cathode of 0.18 ampere per square centimeter. The electrolysis was continued for 18 hours, but the plots are given for only 8 hours, as no change in the direction of the

⁴ Müller, Z. f. anorg. Ch. 22, 33, (1900), and Z. f. Elektroch. 6, 14, (1899).

curves took place during the following 10 hours. The quantities of hypochlorite and chlorate were determined by direct

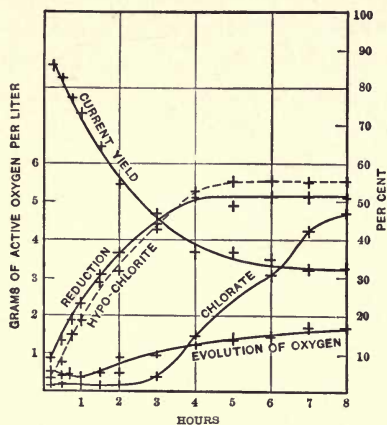

Fig. 24. — Electrolysis of a neutral, 4.37 normal sodium chloride solution

analysis, and are plotted in terms of oxygen contained by each in grams per liter. The corresponding scale of ordinates is on the left. The other curves were obtained by gas analysis as described above. The scale of ordinates for these is given on the right, in per cent.

It will be seen that the fraction of the current used in evolving oxygen and for reduction, and the concentration of the hypochlorite become constant at the same time.

At first the concentration of the chlorate remains low, but increases steadily as soon as the concentration of the hypochlorite becomes constant. This shows that hypochlorite is the first product of the electrolysis and that it is the starting point for the formation of chlorate; also that it is responsible for the evolution of oxygen, as would be expected from equation (16).

The same general effect is produced by electrolysis at 50° C., except that the concentration of the hypochlorite becomes constant at a lower value. This is due to the increase in the hydrolysis of the chlorine as the temperature rises, thus producing a greater concentration of hypochlorite ions on the anode from the beginning. The quantity of hypochlorite ions that has to be supplied to the anode from the solution before they are discharged is therefore less than at a lower temperature; consequently the concentration in the solution will not reach as high a value as in the cold solution before the amount of hypochlorite decomposed equals the amount produced.⁵

⁵ Foerster, *Elektrochemie wässriger Lösungen*, p. 364, (1905).

Both the reduction of the hypochlorite at the cathode and the discharge of the hypochlorite ion on the anode are made more difficult by increasing the current density, as will be seen from the following considerations. The greater the quantity of chlorine coming from the anode, the more it tends to prevent the hypochlorite from reaching the anode, where it would be discharged,⁵ and the smaller the cathode is made, the less opportunity will the hypochlorite have of coming in contact with nascent hydrogen. This is the explanation of the experimental fact that increasing the current density on the cathode lowers the reduction, and on the anode it makes the evolution of oxygen less in the first stages of the electrolysis, which is equivalent to making the concentration of hypochlorite attainable greater.

In a dilute solution of chloride, the maximum hypochlorite concentration is less than in a concentrated solution, because at a given concentration of chloride the hypochlorite must carry relatively more of the current than when there is a greater amount of chloride present, and this results in its being changed to chlorate. Table 10 illustrates the effects of temperature, current density, and concentration changes on the electrolysis of alkali chloride solutions.

The reduction of the hypochlorite can be nearly entirely prevented by the addition of a small amount of potassium chromate to the solution.⁶ Under the action of the current a thin diaphragm is produced that gives the cathode a brownish yellow appearance when compared with a fresh piece of platinum, and which gives a test for chromium when dissolved in nitric acid.⁷ This diaphragm is probably an oxide of chromium, since a cathode of metallic chromium does not prevent reduction. Potassium chromate is as effective with a low-current density as with a high density. The curves⁸ in Figure 25 show the effect of adding 0.18 per cent of chromate to a solution con-

⁶ E. Müller, *Z. f. Elektroch.* 5, 469, (1899); Imhoff, German Patent, 110,420, (1898).

⁷ E. Müller, *Z. f. Elektroch.* 7, 401, (1901).

⁸ E. Müller, *Z. f. Elektroch.* 5, 470, (1899).

taining 30 per cent of sodium chloride. The broken lines refer to the solution without the chromate. The current density on the anode in both cases was 0.075 ampere per square centimeter; on the cathode, 0.18 ampere. The temperature was from 42° to 50° C.

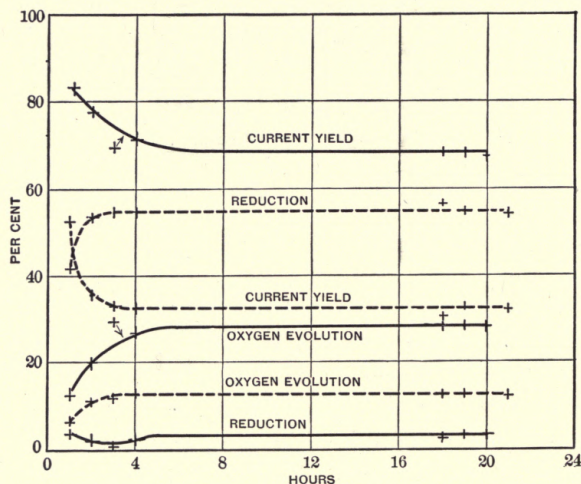
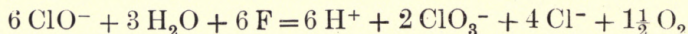

FIG. 25. — Electrolysis of sodium chloride

Full lines refer to solutions containing 0.18 per cent chromate, broken lines to solutions containing no chromate

When potassium chromate is added, the whole loss in current will therefore be due to oxygen evolved according to equation (16), which may be written :



But 12 equivalents of electricity are required to produce 6 equivalents of hypochlorite, according to equation (5), which may be written :

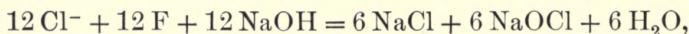

while 6 equivalents are required to discharge the hypochlorite ions required by (16). If as much hypochlorite is to be decomposed by (16) as is produced by (5), it is evident that twice as much of the current must be used in producing hypochlorite as is used in changing it to chlorate. That is, $\frac{2}{3}$ of the current produces active

oxygen in the solution and $\frac{1}{3}$ produces free oxygen, at the same time changing the active oxygen from hypochlorite to chlorate, according to (16). Therefore, excluding reduction and the formation of chlorate by equation (7), when the concentration of the hypochlorite has reached a maximum, in a neutral or slightly alkaline solution, 33.3 per cent of the current will be used to produce free oxygen, and 66.7 per cent to produce active oxygen in the solution.⁹ The oxygen evolution can never be greater than 33.3 per cent unless the concentration of the solution is small, in which case oxygen would be evolved by the discharge of hydroxyl ions. Except for these points, this relation is independent of the other conditions of the experiment, such as temperature, current density, and, within certain limits, the concentration. This is illustrated by the results in Table 10,¹⁰ column 5.

TABLE 10

Solution : 4.8 Normal NaCl and 2 Grams K_2CrO_4 per Liter

TEMPERATURE	AMPERES PER Sq. CM. ON ANODE	LIMITING CONC. OF OXYGEN IN NaClO. GRM. PER 100 c.c.		PER CENT OF CURRENT PRO- DUCING OXYGEN	
		Smooth Pt. Anode	Platinized Pt. Anode	Smooth Pt. Anode	Platinized Pt. Anode
13	0.017	0.34	0.61	33.3	31.0
13	0.17	0.68	0.89	30 to 33	34.5
50	0.017	0.17	0.31	30 to 31	22.0
50	0.17	0.42	0.64	30	28.0

The Solution Changed to One 1.7 Normal NaCl and Containing 2 Grams K_2CrO_4 per Liter

13	0.017	0.28	0.48	34	33.5
13	0.17	0.47	0.65	32.5	35
50	0.017	0.15	0.23	33.5	29 to 31
50	0.17	0.35	0.40	33	33 to 34
75	0.017	0.09	0.15	34	25 to 27
75	0.17	0.25	0.32	35 to 36	29

⁹ Foerster and Müller, Z. f. Elektroch. 9, 199, (1903).¹⁰ Foerster and Müller, Z. f. Elektroch. 9, 196, (1903).

In the above experiments, when the oxygen evolution is less than 33.3 per cent, hypochlorite is lost by the secondary formation of chlorate. Columns 3 and 5 show that the maximum concentration of hypochlorate is different under different conditions, but that when this concentration is reached, the fraction of the current used in oxygen evolution is practically the same under widely differing conditions.

If the solution of sodium chloride is made acid with hydrochloric acid at the beginning of the electrolysis, the first effect of electrolysis is to decompose the acid until the solution becomes nearly neutral.¹⁰ There always remains a small quantity of the free acid throughout the solution, however, liberating free hypochlorous acid, which oxidizes the hypochlorate to chlorate through the entire solution, according to equation (7). This gives a method of increasing the yield in chlorate over that attainable in neutral or alkaline solutions, in which it has been shown above that the maximum yield is 66.7 per cent. If, before the maximum concentration of hypochlorite has been reached, a quantity of acid is added to the solution which is equivalent to only a fraction of the hypochlorite in the solution, the latter is completely oxidized to chlorate. Further electrolysis produces more hypochlorite, to which acid may again be added, producing more chlorate.¹¹ By this means, chlorate can be produced on smooth platinum electrodes with nearly 90 per cent of the theoretical current yield. In place of adding the requisite amount of hydrochloric acid from time to time, the solution may be kept slightly acid by the addition of potassium acid fluoride, KHF_2 , as patented by the Siemens and Halske Company,¹² or of alkali bicarbonate, which is patented by the Aktiengesellschaft vorm. Schuckert & Co.¹³

Oettel found in his early experiments that adding 0.3 gram of potassium hydrate to 100 cubic centimeters of a solution containing 20 grams of potassium chloride does not materially affect the result of the electrolysis, but that as the alkalinity is

¹¹ Foerster and Müller, *Z. f. Elektroch.* **8**, 13, (1902).

¹² Foerster and Müller, *Z. f. Elektroch.* **10**, 731, (1904).

¹³ Foerster and Müller, *Z. f. Elektroch.* **8**, 12, (1902).

increased, the maximum concentration of hypochlorite becomes less, and the principal product of the electrolysis is chlorate and free oxygen.¹⁴ The curves in Figure 26¹⁵ show the quantities of chlorate and hypochlorite produced per liter by electrolyzing for one hour solutions containing 200 grams of sodium chloride and varying quantities of sodium hydrate in one liter. The ordinates are grams of oxygen per liter contained in the chlorate or hypochlorite of the solution, and the abscissæ, the number of grams of sodium hydrate added to one liter of the solution. The current density on the anode was 0.04 ampere per square centimeter.

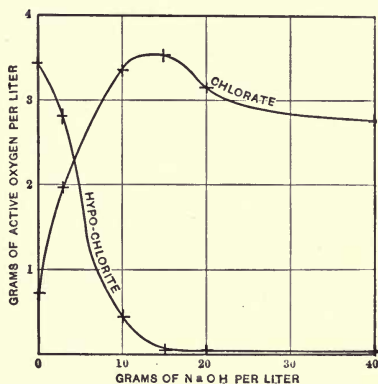

FIG. 26. — Effect of alkalinity on the electrolysis of a solution of sodium chloride

This reduction in the hypochlorite concentration and increase in that of the chlorate with increasing alkalinity is explained as follows: The reaction by which the chlorate is formed in strongly alkaline solutions is the same as that in neutral or slightly alkaline solutions, and is given in equation (16), and the difference produced by the strong alkalinity is that the chloride finds hydroxyl ions with which to react immediately on the anode, forming hypochlorite. There is therefore a much higher concentration of hypochlorite immediately on the anode than throughout the rest of the solution, and consequently its discharge and the production of chlorate take place when the concentration throughout the solution is very low.¹⁶ When the alkalinity is further increased, the hydroxyl ions also begin to be discharged and the yield in chlorate falls below 66.7 per cent, which accounts for the maximum point in the chlorate curve.

¹⁴ Z. f. Elektroch. 1, 474, (1895).

¹⁵ Müller, Z. f. Elektroch. 6, 20, (1899); Z. f. anorg. Ch. 22, 72, (1900).

¹⁶ Foerster and Müller, Z. f. Elektroch. 9, 182, and 200, (1903); also Foerster, Elektrochemie wässriger Lösungen, p. 366, (1905).

Another difference in the electrolysis of strongly alkaline solutions is the effect of temperature. Higher temperature in neutral solutions decreases the maximum concentration of hypo-

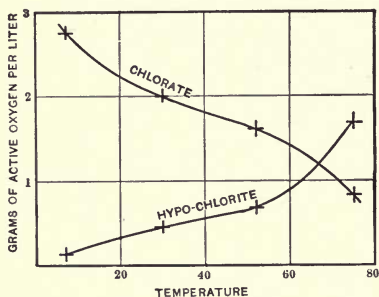

FIG. 27. — Effect of temperature on the electrolysis of an alkaline solution of sodium chloride

chlorite obtainable, but in strongly alkaline solutions the effect of temperature is just the reverse, as shown in the curves in Figure 27.¹⁵ The ordinates are the number of grams of oxygen contained in the hypochlorite or chlorate in one liter of a solution originally containing 200 grams of sodium chloride and 40 grams of sodium hydrate in the same volume. The

electrolyses lasted one hour each, with a current density on the anode of 0.045 ampere per square centimeter. Increasing the anode current density tends to counteract this temperature effect. From the explanation given of these curves¹⁷ it does not seem that the effect of temperature in strongly alkaline solutions is thoroughly understood.

The Electrolysis of Alkali Chlorides with Platinized Platinum Anodes

Lorenz and Wehrin¹ showed that the use of a platinized platinum anode increases the maximum concentration of hypochlorite, and that the oxygen evolution and the production of chlorate do not begin at a time when, on smooth platinum, under the same conditions of the experiment, the oxygen evolution would be considerable. When the electrolysis is continued for a longer time, however, oxygen evolution and chlorate formation begin just as on smooth platinum anodes, and according to the same reaction.² The only difference is that a higher

¹⁷ Foerster and Müller, *Z. f. Elektroch.* **9**, 205, (1903)

¹ *Z. f. Elektroch.* **6**, 437, (1900).

² Foerster and Müller, *Z. f. Elektroch.* **8**, 515, (1902).

concentration of hypochlorite is produced before the quantity decomposed in a given time is equal to that produced. This is illustrated by the curves in Figure 28, obtained with a 5.1 normal solution of sodium chloride, containing 2 grams of potassium chromate per liter.²

The broken curves were obtained with a smooth platinum anode, the solid curves with a platinized anode. The ordinates on the right give the per cent of the current yield and the per cent of the current used for the evolution of oxygen, while on the left the ordinates give the number of grams per liter of oxygen in the form of chlorate and hypochlorite.

The current density on the anode was 0.067 ampere per square centimeter. An explanation of the higher concentration of hypochlorite obtained with platinized anodes will be given below in discussing potentials and decomposition points.

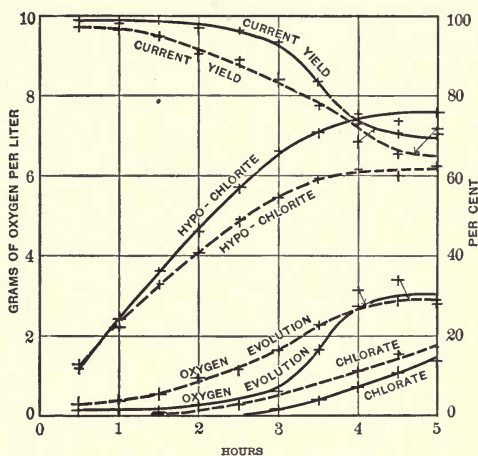

FIG. 28. — The electrolysis of a 5.1 n. sodium chloride solution, containing 2 grams of potassium chromate per liter

Dotted lines refer to smooth platinum anode, full lines to platinized platinum anode

The Electrolysis of Alkali Chlorides on Carbon Anodes

All carbon electrodes are more or less porous; that portion of their entire volume which consists of pores, or the porosity, varies from 11.2 to 27.8 per cent for different kinds of carbon. For Acheson graphite the porosity is 22.9 per cent.¹ The porosity is calculated from the true and the apparent densities.

¹ Foerster, *Elektrochemie wässriger Lösungen*, p. 372, (1905).

The apparent density b is the weight of one cubic centimeter of the material, while the true density a is the weight divided by the volume actually occupied by the material. The value of a is determined by mixing bromoform and chloroform in such proportions that small pieces of the carbon will neither sink nor float when saturated with the mixture.² The density of the mixture is then determined by any of the well-known methods, and thus gives that of the carbon directly. The value of the porosity is then $100 \frac{a-b}{a}$ per cent.

On dipping a carbon electrode into a solution, the pores become filled with the solution, and the solution contained in the electrode is electrolyzed as well as that on the surface; but since the dissolved salt cannot be replaced in the pores as rapidly as in the solution on the surface of the electrode, where stirring replaces the salt decomposed, the solution contained in the pores becomes more dilute than on the surface. Consequently the evolution of oxygen and the production of chlorate will begin sooner, and the maximum concentration of hypochlorite will be less than on a platinum electrode, when the other conditions of the experiment are the same.³

The effect of changing the chloride concentration or the anode current density on the yield of hypochlorite and on the maximum concentration attainable with carbon anodes is in the same direction as with platinum electrodes.

A part of the oxygen liberated oxidizes the carbon to carbon dioxide, part of which, remaining in the solution, makes the solution slightly acid, and therefore changes the hypochlorite to chlorate by equation (16). The formation of carbonic acid takes place in solutions at 20° only to a small extent and after several hours, but at 60° it begins at once, and the total quantities contained in the gases evolved and dissolved in the solution amount to as much as 27 per cent of the amount that would be produced if this were the only product on the anode of the electrolysis.⁴

² Zellner, Z. f. Elektroch. 5, 450, (1899).

³ L. Sproesser, Z. f. Elektroch. 7, 1083, (1901).

⁴ Z. f. Elektroch. 7, 944 and 1014, (1901).

Carbon anodes are also subject to mechanical destruction, due to crumbling, and in some kinds of carbon this may exceed the loss due to chemical action.

The solution in the pores of the carbon may eventually become so dilute that hydroxyl ions are discharged, causing the production of hydrochloric acid around the anode ; for hydrogen ions are left behind by the discharge of hydroxyl ions and, coming in contact with chlorine ions migrating from the anode, form hydrochloric acid. This fact will be shown later to be of some practical importance.

Acheson graphite has been found to last better in the electrolysis of chlorides than any other kind of carbon.¹

The Maximum Concentrations of Hypochlorite and the Maximum Current and Energy Yields of Hypochlorite and Chlorate

From what has preceded, it will be evident that the best conditions for obtaining a high concentration in hypochlorite are to have a neutral, concentrated chloride solution, a low temperature, platinized anodes, and to prevent reduction by potassium chromate. Column 4 in Table 11 shows the maximum amount of hypochlorite obtainable under different conditions of the experiment.¹ The values given in grams of oxygen may be changed to grams of chlorine by multiplying the former by $\frac{35.45}{16} = 2.22$.² The solution was 4.79 normal with respect to sodium chloride and contained 2 grams of potassium chromate per liter. In the last experiment the solution was only 1.73 normal. Both electrodes were platinized.

Since the decomposition value of a concentrated solution of sodium chloride on either smooth or platinized platinum is 2.2 volts, the minimum amount of energy necessary to produce

¹ Foerster and Müller, Z. f. Elektroch. 8, 10, (1902).

² Foerster and Müller use the ratio 4.44, which is the ratio of the chemical equivalence of the chlorine and oxygen contained in hypochlorite. The ratio of the weights contained, however, is 2.22.

one gram of oxygen in the form of hypochlorite is 7.4 watt hours. From the table it is evident that with the lowest current density this value is very closely approached.

TABLE 11

TEMP. IN CENTIGRADE DEGREES	AMPERES PER SQ. CM. ON ANODE	VOLTS	GRAMS PER LITER		CURRENT YIELD IN PER CENT	WATT HOURS PER GRAM O ₂ IN HYPOCHLORITE
			Of O ₂ in Hypochlo- rite	Of Cl ₂ in Hypochlo- rite		
13	0.017	2.40	4.20	9.3	96	8.4
13	0.017	2.40	5.24	11.6	90	8.95
10	0.07	3.10	6.8	15.0	96	10.84
13	0.17	3.6	5.28	11.7	99	12.2
13	0.17	3.6	8.7	19.8	87	13.5
14	0.17	4.7	5.20	11.5	95	16.6

If chlorate is produced entirely secondarily by acidifying the solution from time to time, no energy is required for its formation beyond the 7.4 watt hours necessary for the production of the hypochlorite. By working in this way and by using platinized electrodes, an average current yield of 98 per cent was obtained in a run in which 3.66 volts were applied to the cell.³ This is 12.5 watt hours per gram of oxygen in the form of chlorate. The current density was 0.117 ampere per square centimeter. By reducing the current density the theoretical value of 7.4 watt hours could of course be more nearly approached.

The Production of Perchlorates

A perchlorate is a more stable compound than a chlorate, since, as is well known, a chlorate on heating first breaks up into perchlorate, chloride, and oxygen, according to the equations:¹

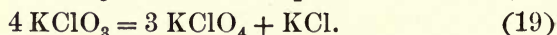
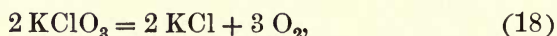

³ Foerster and Müller, *Z. f. Elektroch.* **8**, 16, (1902).

¹ Roscoe and Schorlemmer, *Treatise on Chemistry*, **1**, 235, (1905).

A solution of chloric acid is also unstable when its concentration exceeds a certain value, and breaks up as follows:²



The chloric and chlorous acids then react according to the following reversible reaction:

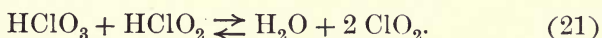

These reactions are similar to those by which hypochlorous acid breaks up,

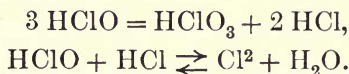

Perchlorates are produced in a purely chemical way only by the breaking up of a chlorate, and not by direct oxidation.

The electrolytic production of perchlorate and of perchloric acid was discovered by Count Stadion³ in 1816, but the way in which this oxidation takes place was not understood until recently. This is not a direct oxidation of chlorate to perchlorate, as would be expressed by the equation:

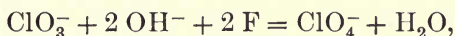

but is due to the discharge of the chlorate ions and their subsequent reaction with water, as follows:⁴



The oxygen does not escape, but oxidizes the chlorous acid back to chloric acid:

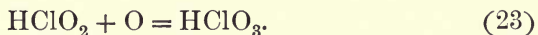

The principal facts concerning the production of perchlorate are: (1) If the concentration of the chlorate is over 8 per cent, a change in its concentration has no appreciable effect on the current yield; (2) the yield increases with increasing current density; (3) the yield falls with increasing temperature; (4) platinizing the anode decreases the yield and (5) in

² Oechsli, *Z. f. Elektroch.* **9**, 807, (1903).

³ Gilbert's *Ann.* **52**, 218, (1816).

⁴ Oechsli, *l.c.*, p. 819.

electrolyzing alkali chlorides, perchlorate is not produced until nearly all of the chloride has been changed to chlorate.

In an acid or neutral chlorate solution, perchlorate can be produced with a high current yield, as Table 12 shows, giving the results of an experiment in which 66 per cent sodium chlorate solution was electrolyzed with a smooth platinum anode on which the current density was 0.083 ampere per square centimeter. The temperature was 9° C.

TABLE 12

TIME IN MINUTES FROM BEGINNING OF ELECTROLYSIS	CURRENT YIELD PER CENT
5	96.4
20	99.5
35	99.9
180	99.9
210	99.8
300	99.1

Alkalinity prevents the formation of perchlorates; the current yield falls to 16 per cent for a solution 0.242 normal with respect to sodium hydrate, with the same current density as in the experiment above. This is probably due to the smaller number of chlorate ions that are liberated as the alkalinity is increased, furnishing hydroxyl ions that are more easily discharged than the chlorate. An increase in the current density would be expected to counteract this effect of the alkali, and experiment shows that it does. The lower yield with platinized anodes is due to the lower current density produced by the larger surface.

The reduction in the yield by an increase in the temperature is supposed to be due to the greater concentration of hydroxyl ions of water from the increase in the dissociation with the temperature.

The Electrolysis of Alkali Chlorides with a Diaphragm

If the object in electrolyzing an alkali chloride is to produce an alkali hydrate and chlorine, the anode and cathode must be separated in order to prevent the hydrate and chlorine from mixing. There are four ways in which the separation of the hydrate and chlorine is effected. These are: (1) by the use of a diaphragm; (2) by inclosing the anode in an inverted, non-conducting bell, with the cathode outside; (3) by charging a mercury cathode with sodium in an electrolytic cell and decomposing the sodium amalgam with water in another vessel; and (4) by a mercury diaphragm, which acts as an intermediate electrode.

(1) Since electrolytic conduction takes place through a diaphragm, it is evident that the separation in this case will not be perfect, for the diaphragm prevents only mechanical mixing. The hydroxyl ions will migrate through the diaphragm and react with the chlorine in the same way as described above. The hydroxyl ions also pass through the diaphragm by ordinary diffusion. Electro-osmosis, on the other hand, drives the liquid through the diaphragm from the anode to the cathode, and therefore opposes the diffusion and migration of the hydroxyl ions.¹

If diffusion and osmosis just balance each other, the yield in hydrate can be calculated as follows.¹ Before sodium hydroxide appears at the diaphragm, the sodium chloride transports all of the electricity, but when the hydrate is mixed with the chlorine, the hydrate will also take part in carrying the current through the diaphragm. If the fraction of the current carried by the hydrate is x , that carried by the chloride will be $1 - x$, and x and $1 - x$ must be proportional to the conductivities of the hydrate and of the chloride in the solution. If L_1 is the conductivity of the chloride and L_2 that of the hydrate, this is expressed by the equation:

$$\frac{1 - x}{x} = \frac{L_1}{L_2} = \frac{c_1 \alpha_1 \lambda'_{\infty}}{c_2 \alpha_2 \lambda''_{\infty}}, \quad (24)$$

¹ Foerster and Jorre, Z. f. anorg. Ch. 23, 158, (1899).

in which c_1 and c_2 are the concentrations in moles per liter, α_1 and α_2 are the dissociations, and λ'_∞ and λ''_∞ are the conductivities at infinite dilution, of the chloride and hydrate respectively. For potassium chloride and potassium hydrate, $\frac{\lambda'_\infty}{\lambda''_\infty} = 0.545$, and for sodium chloride and sodium hydrate, the value of this fraction is 0.502. For potassium chloride and potassium hydrate, equation (24) becomes

$$\frac{1 - x'}{x'} = 0.545 \frac{c_1 \alpha_1}{c_2 \alpha_2},$$

or

$$x' = \frac{1}{1 + 0.545 \frac{c_1 \alpha_1}{c_2 \alpha_2}}, \quad (25)$$

and for sodium hydrate and sodium chloride,

$$x'' = \frac{1}{1 + 0.502 \frac{c_1 \alpha_1}{c_2 \alpha_2}}. \quad (26)$$

Now if all of the current were carried by the hydrate, and if n were its transference number, n equivalents of hydrate would pass out of the cathode compartment through the diaphragm in the same time that one equivalent is produced. In this case the yield in hydrate would be

$$A = 100 (1 - n) \text{ per cent.}$$

The hydrate carries only a fraction of the current, however, equal to x . The yield is therefore

$$A = 100 (1 - nx) \text{ per cent.}$$

The transference number, n , for potassium hydrate is 0.74, and for sodium hydrate it is 0.83.² Substituting the values for x in equations (25) and (26), and the values for n just given, for potassium,

$$A_K = 100 \left[1 - \frac{0.74}{1 + 0.545 \frac{c_1 \alpha_1}{c_2 \alpha_2}} \right], \quad (27)$$

² Foerster, Elektrochemie wässriger Lösungen, p. 400, (1905).

and for sodium,

$$A_{\text{Na}} = 100 \left[1 - \frac{0.83}{1 + 0.502 \frac{c_1 \alpha_1}{c_2 \alpha_2}} \right]. \quad (28)$$

It is evident from these equations that, as the hydrate becomes more concentrated, the fraction in the parenthesis becomes greater, which reduces the value of A . Table 13 shows how the yield decreases as the concentration increases.³ The electrolysis was carried out with 700 cubic centimeters of a solution containing 200 grams of potassium chloride per liter in the cathode compartment, and 500 cubic centimeters of the same solution in the anode compartment. The electrodes were platinum, and the diaphragm was of Pukal clay. The current density on the diaphragm was 0.016 ampere per square centimeter. The yield which was being obtained at the end of each period was calculated by formula (27) from the values of the concentrations of chloride and hydrate existing at the end of the period, assuming that the dissociation of the hydrate and chloride are equal.

TABLE 13

TIME	GRAMS OF KOH PRODUCED	GRAMS CU DEPOSITED IN COULOMETER	MEAN CURRENT YIELD FOR THE CORRESPONDING 2 HRS.	EQUIVALENTS PER LITER IN THE CATHODE COMPARTMENT OF		COMPUTED CURRENT YIELD PER CENT
				Chloride	Hydrate	
1st 2 hrs.	17.78	11.47	88.08	2.382	0.418	81.3
2d 2 hrs.	14.29	11.71	69.30	2.224	0.754	70.4
3d 2 hrs.	13.60	11.61	66.50	2.096	1.071	62.6
4th 2 hrs.	11.11	11.85	58.02	2.066	1.331	55.0

It will be seen from the numerical values in equations (27) and (28) that the yield of hydrate with potassium chloride will be better than with sodium chloride, at 18°, to which temperature these numbers apply. Since, however, all transference numbers approach the limit 0.5 as the temperature is raised, these formulæ indicate that the yield in hydrate would increase with the tem-

³ Foerster and Jorre, Z. f. anorg. Ch. 23, 193, (1899).

perature and approach the same value for sodium and potassium chlorides. Since a rise in the temperature also increases the diffusion, the increase in the yield which would be predicted by the formula would be somewhat too large.³

Since the hydroxyl ions that migrate to the anode compartment find an excess of chlorine, hypochlorous acid will be produced according to equation (2):

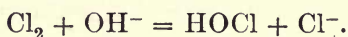

If this proceeded indefinitely, the loss in chlorine would be twice the loss in hydrate. On platinum anodes this has been found to be true in the first stages of the electrolysis. As the hypochlorous acid becomes more concentrated, compared to the chlorine, it will be neutralized by the hydroxyl ions coming through the diaphragm, forming hypochlorite. This is then immediately oxidized to chlorate by the excess of hypochlorous acid, according to equation (7). Consequently, no hypochlorite is found in the anode compartment.

The process in the anode compartment is essentially the same when carbon anodes are substituted for platinum, with the exception, of course, that carbon dioxide, as well as oxygen, is produced.

(2) The principle of the *bell process* is illustrated in Figure 29. The anode is placed in a bell and the cathode outside. The current flows under the lower rim of the bell from anode

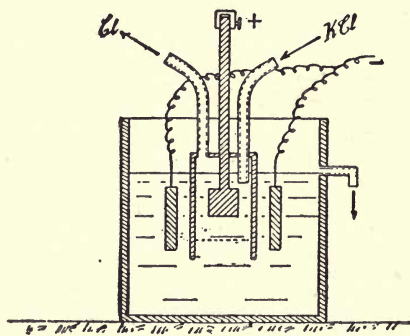

FIG. 29. — Bell process

to cathode. Chlorine is evolved and passes out through the tube in the top of the bell, while hydrate is formed on the cathode. The process that takes place in this cell is very similar to that in a cell with a diaphragm.⁴ At first the solution

⁴ Gustav Adolph, Z. f. Elektroch. 7, 581, (1901).

in the anode compartment is divided into three sharply defined layers, the upper one saturated with chlorine, next to this a layer of unchanged chloride, and below this a layer containing a large number of hydroxyl ions. The hydroxyl ions migrate towards the anode, and on coming in contact with an excess of chlorine react in the same way as when a diaphragm is used.

With carbon anodes in the bell process, a much higher hydrate concentration can be obtained without destroying the middle layer of the neutral solution separating the chlorine from the hydroxide; at the same time, however, the current yield is less than the theoretical. This is due to the fact that free oxygen is always evolved on carbon anodes, producing free hydrochloric acid. The hydrogen ions from this acid migrate towards the cathode and neutralize the hydroxyl ions migrating towards the anode, and thus prevent their coming in contact with free chlorine. In consequence of this, much more highly concentrated solutions of hydrate can be produced by the bell process with the same energy yield than by the diaphragm process.⁵

In actual practice the bell process is always carried out with a circulating electrolyte. Fresh chloride solution flows into the anode compartment, where it must be spread out uniformly over the entire area of the bell, so that the neutral layer will not be disturbed.

In the bell process the losses of chlorine and hydrate are equal, so that the current yields in chlorine and hydrate must also be equal. The chlorine dissolved in the anode solution is carried through the neutral layer by circulation and is changed to hypochlorite on coming in contact with the hydroxyl ions below. This is reduced on the cathode, producing an equal loss in hydrate. The loss in chlorine at the anode by the evolution of oxygen also produces an equal loss in hydrate, for the hydrochloric acid left behind by the oxygen neutralizes an equivalent amount of hydrate.⁶

With a circulating electrolyte a current yield of from 85 to

⁵ Adolph, *l.c.* p. 589.

⁶ Otto Steiner, *Z. f. Elektroch.* 10, 320, (1904).

94 per cent can be obtained, with the concentration of potassium hydrate 120 to 130 grams per liter, and the chlorine 97 to 100 per cent pure, using a current density referred to the area of the bell of 2 to 4 amperes per square decimeter, and from 3.7 to 4.2 volts.⁷

(3) The third method of separating the hydrate from the chlorine consists in depositing the metal in a mercury cathode, which is then removed from the cell and treated with water. The sodium or potassium reacts with the water, forming the hydrate, and the mercury is returned to the cell to be used over again. The losses in this process are due to the recombination of chlorine dissolved in the solution with the alkali metal in the amalgam, and to the reaction of the alkali metal with the water before leaving the electrolyzing cell. The former loss may amount to 100 per cent under some circumstances, while the loss due to the decomposition of water is small.⁸ In order to reduce the recombination of the chloride and the alkali metal, the current density on the cathode should be high and also the concentration of the amalgam. Strange as it may seem, the potassium amalgam is more resistant to chlorine, the more concentrated it is. For example, increasing the concentration of the amalgam from 0.012 per cent to 0.06 per cent increased the yield in comparable experiments from zero to 90 per cent. A current density of 0.1 ampere per square centimeter gave an 88 per cent current yield. Since the principal loss is due to a recombination of the chlorine and the alkali metal, the yield will be the same for both alkali and chlorine. If the amalgam is covered with a diaphragm to protect it from the chlorine, current yields of 98 per cent can be obtained.⁸

(4) The fourth method of separating the hydrate from the chlorine consists in using mercury as an intermediate electrode. The principle of this process is illustrated in Figure 30. The electrolytic cell is seen to consist of three compartments; the two outer are the anode compartments containing the graphite anodes *AA*, and the middle compartment contains the cathode

⁷ Z. f. Elektroch. **10**, 330, (1904).

⁸ F. Glaser, Z. f. Elektroch. **8**, 552, (1902).

C, consisting of an iron grid. The covers of the anode compartments have pipes, not shown in the figure, for leading off the chlorine, but the cathode compartment is only loosely covered, so that the hydrogen escapes in the air.

The partitions separating the compartments do not quite reach to the bottom of the cell, but the opening is closed by a layer of mercury covering the bottom of the cell. The alkali metal is electrolyzed into the mercury in the anode compartment and is electrolyzed out in the cathode compartment. In the cathode compartment the amalgam is the anode, and the

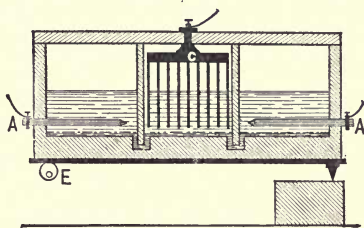

FIG. 30. — Cell with mercury diaphragm

alkali metal unites with the hydroxyl ions liberated on it and forms hydrate. In order to stir up the amalgam so that the alkali metal will get into the cathode compartment as soon as possible, the whole cell is slowly tilted back and forth, causing the mercury to flow from one compartment to the other.

In this system the current density on the cathode must also be at least 0.1 ampere per square centimeter.⁹ The speed of rocking the cell also affects the yield, an increase in the rapidity decreasing the yield. One of the difficulties encountered in this process is that if the alkali metal becomes too dilute in the amalgam, the mercury is itself oxidized in the anode compartment. To avoid this, a part of the current is taken directly from the mercury by a shunt circuit in which there is a suitable resistance to make the shunted current about one tenth of the total current. A decrease in the concentration of the chloride solution reduces the current yield. With a 30 per cent potassium chloride at a temperature of 40°, and with a current density of 0.1 ampere per square centimeter, Cantoni obtained a current yield in hydrate of 90 per cent.

⁹ Le Blanc and Cantoni, *Z. f. Elektroch.* 11, 611, (1905).

Decomposition Points and Potentials of Alkali Chloride Solutions

In a chloride solution before electrolysis there are only the hydroxyl and chlorine anions, while after the electrolysis there are also hypochlorite and chlorate anions. The cations are the alkali metal and hydrogen both before and after electrolysis. A knowledge of the potential differences between anode and solution at which the different anions are discharged will help in understanding the chloride electrolysis.

The potential difference at which an ionized substance is discharged, or, what is the same thing, if the process is reversible, the potential difference produced by the substance when brought in contact with a platinum electrode, is dependent on its chemical nature and on its concentrations in the charged and discharged conditions. Thus the potential difference between a platinum electrode charged with chlorine and a chloride solution is

$$e = \frac{RT}{2} \log \frac{k C_{\text{Cl}_2}}{(C_{\text{Cl}^-})^2} = \frac{RT}{2} \left[\log k + \log \frac{C_{\text{Cl}_2}}{(C_{\text{Cl}^-})^2} \right], \quad (29)$$

where C_{Cl_2} is the concentration of free chlorine in moles per liter surrounding the anode, C_{Cl^-} is the concentration of chlorine ions in the solution, and k is a constant. If C_{Cl_2} and C_{Cl^-} are both equal, the value of e is $\frac{RT}{2} \log k$, and is called the electrolytic potential. For a solution saturated with chlorine at atmospheric pressure containing 0.064 mole per liter, and normal with respect to chlorine ions, $e = -1.667$ volts,¹ assuming the potential of the dropping electrode to be zero. The negative sign indicates that the solution is negatively charged. Chlorine cannot therefore be liberated at atmospheric pressure at a potential difference less than this value. On a platinized platinum cathode in an acid solution, normal with respect to hydrogen ions, hydrogen would be liberated at -0.277 volt. But the solution around the cathode is neutral to start with, and soon after the electrolysis has begun is alkaline, due to the

¹ Müller, Z. f. phys. Ch. 40, 158, (1902).

formation of alkali hydrate. The hydrogen ion concentration is then very much reduced below its value in the original neutral solution. This alkalinity might have any value, but for the purpose of calculation the solution around the cathode will be assumed normal, though it would not reach such a high value in a cell not containing a diaphragm. The value of the potential of the cathode on which hydrogen is being liberated would then be 0.54 volt, 0.82 volt more positive than the potential in a normal acid solution.² The cell would then have an electromotive force of its own of

$$e = 0.54 - (-1.66) = 2.20 \text{ volts.}$$

The decomposition point of a concentrated solution of sodium chloride, determined, as usual, with a very small current, is 1.95 volts, but this is because the solution around the cathode is more nearly neutral than assumed above. Continuous electrolysis requires from 2.3 to 2.1 volts.³

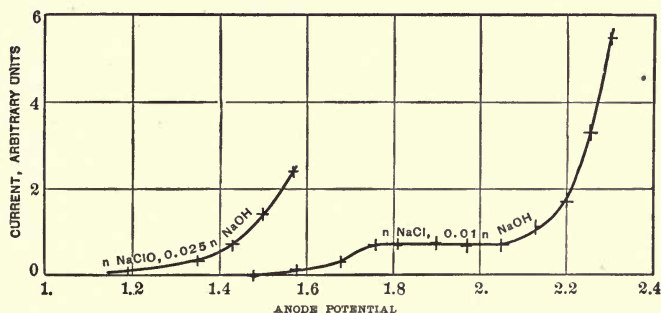

FIG. 31. — Curves showing the relation between current and anode potential, in solutions of sodium chloride and of sodium hypochlorite

As was shown above, when the hypochlorite reaches a certain concentration, the hypochlorite ion is also deposited on the anode. It has never been possible to determine the decomposition point of this ion, however. It is evident from the curves in Figure 31,⁴ in which the decomposition points of two solutions are

² Le Blanc, *Electrochemistry*, p. 209, (1907).

³ Lorenz, *Z. f. Elektroch.* 4, 247, (1897).

⁴ Foerster and Müller, *Z. f. Elektroch.* 8, 634, (1902).

given, one normal with sodium hypochlorite and 0.025 normal with sodium hydrate, the other normal with sodium chloride and 0.01 normal with sodium hydrate, that hypochlorite ions are not liberated before hydroxyl ions. This is shown by the fact that there was no increase in the current below the potential -1.16 volts, approximately the point at which hydroxyl ions are liberated in a normal hydrate solution. It is also evident that the electrolysis of a normal chloride solution begins at a higher potential than the hypochlorite solution. The decomposition point of the hypochlorite ion therefore lies between those of the hydroxyl and the chlorine ions.

Since there is a difference of about 0.5 volt between the decomposition points of chlorine and hydroxyl ions, it would seem impossible to liberate chlorine ions in a strongly alkaline solution. This would be the case if it were not that the potential of an anode on which oxygen is liberated increases continuously, and eventually reaches the potential at which chlorine is liberated. If it were not for this increase in the potential, caused by the liberation of oxygen, the decomposition of a chloride in an alkaline solution would be impossible.⁵ Another effect which tends to make chlorine deposit in an alkaline solution is the fact that the hydrate has a depolarizing effect on the chlorine, in consequence of which chlorine will be liberated at a lower potential than that necessary for its deposition at atmospheric pressure. Table 14 shows

TABLE 14

ANODE POTENTIAL	AMPERES	PER CENT YIELD IN ACTIVE OXYGEN		
		Total	As Hypo- chlorite	As Chlorate
-1.09	—	—	0.0	—
-1.21 to -1.27	0.016	—	0.9	—
-1.30 to -1.51	0.28 to 0.14	3.2	2.6	0.6
-1.51 to -1.595	0.5 to 0.4	16.4	8.2	8.2

⁵ Foerster and Müller, *Z. f. Elektroch.* **9**, 184, (1903).

that hypochlorite and chlorate are formed in a solution normal with sodium hydrate, and 3.6 normal with sodium chloride, at an anode potential below -1.667 volts, the potential at which chlorine is liberated at atmospheric pressure.⁶ The anode was platinized platinum, of 14 square centimeters area.

It will be noticed that as the anode potential increases in numerical value, the proportion of chlorate to hypochlorite increases. This is due to the fact that the hypochlorite ions, which are more easily discharged than the chlorine ions, are more subject to deposition as the potential of the anode in-

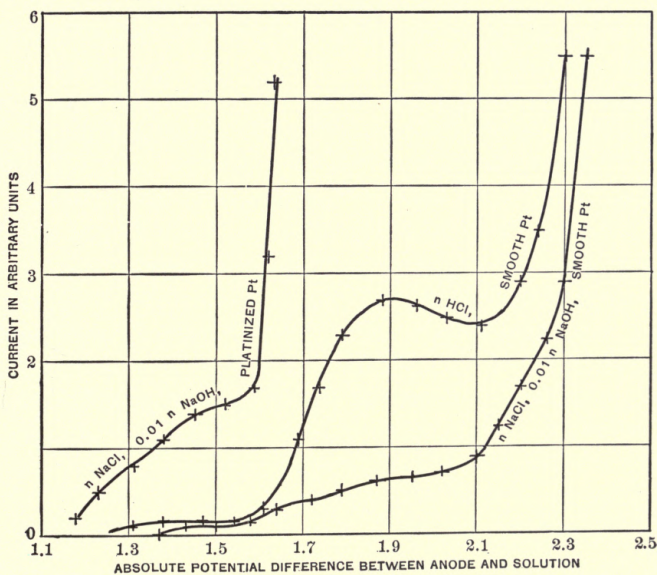

FIG. 32. — Curves showing the relation between current and anode potential for smooth and for platinized platinum anodes

creases, with the subsequent production of chlorate according to equation (16).

On smooth platinum anodes the potential difference during electrolysis is about 0.58 volt greater than on platinized platinum.⁷ The decomposition points of sodium chloride on plati-

⁶ Foerster and Müller, *Z. f. Elektroch.* **9**, 183, and 201, (1903).

⁷ *Z. f. Elektroch.* **6**, 437, (1900).

nized platinum and on smooth platinum anodes shows the same difference, as is seen from the curves in Figure 32.⁸ It is evident that the overpressure of an anion is a function not only of its own chemical nature, but also of the solution from which it is deposited, of the current density, and of the material composing the anode.

The cause of this overpressure of 0.58 volt on platinum is not well understood; it may be due to the resistance of a film of gas liberated on the anode. There is a corresponding overvoltage in other solutions, such as sodium hydrate and sulphuric acid, where oxygen, in place of chlorine, is liberated. These overpressures are not equal for the same current density in these different solutions.⁹

Though the overpressure on smooth platinum anodes may not itself be understood, its presence offers a possible explanation of the higher concentration of hypochlorite obtained with a platinized anode, for the relation between the decomposition potential and the concentration of ions is that the decomposition potential decreases as the concentration increases. Therefore, with a lower anode potential, the concentration of the hypochlorite ions would have to be greater before decomposition takes place.¹⁰

It is an experimental fact, as has been stated above, that very little perchlorate is produced until most of the chloride has been changed to chlorate. This is due to the fact that the decomposition potential of normal sodium chlorate is 2.36 volts,¹¹ while that of the chloride is 1.95 volts.³ The high potential required for the deposition of the chlorate cannot therefore be reached until most of the chloride has been used up.

When chlorine is dissolved in water, according to equations (2) and (4), a certain amount of hypochlorous acid and hypochlorite will be produced. Both hypochlorous acid and hypochlorite are oxidizing agents, and therefore give an unattackable

⁸ Müller, *Z. f. Elektroch.* **8**, 426, (1902).

⁹ Foerster and Müller, *Z. f. Elektroch.* **8**, 533, (1902).

¹⁰ Foerster and Müller, *Z. f. Elektroch.* **9**, 199, (1903).

¹¹ Wohlwill, *Z. f. Elektroch.* **5**, 52, (1898).

electrode a definite potential. If the reactions by which they give off oxygen, or what is the same thing, hydroxyl ions, are

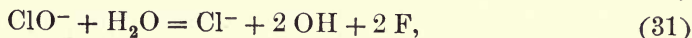
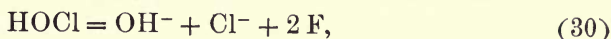

the potentials would be given by the equations

$$e_2 = \frac{RT}{2} \log \frac{k_2 C_{\text{HOCl}}}{C_{\text{OH}^-} \cdot C_{\text{Cl}^-}}, \quad (32)$$

$$e_3 = \frac{RT}{2} \log \frac{k_3 C_{\text{ClO}^-}}{C_{\text{OH}^-}^2 \cdot C_{\text{Cl}^-}} \quad (33)$$

and for equilibrium concentrations,

$$e_1 = e_2 = e_3, \quad (34)$$

e_1 being taken from equation (29). When chlorine is liberated on an unattackable anode, the equilibrium represented by (9),

$$\frac{C_{\text{Cl}_2}}{C_{\text{Cl}^-}} = 3.6 \times 10^{-11} \frac{C_{\text{HOCl}}}{C_{\text{OH}^-}} = 1.4 \times 10^{-17} \frac{C_{\text{ClO}^-}}{C_{\text{OH}^-}^2},$$

must be established, and, assuming the chlorine electrode is reversible, the production of hypochlorite and hypochlorous acid must be, according to (31) and (32), taken from right to left. This means that a primary production of hypochlorite and hypochlorous acid takes place on the anode to a small extent.

Fluorides, Bromides, and Iodides

The electrolysis of the other alkali halogen compounds has not attained anything like the commercial importance of the electrolysis of chlorides; still, for the sake of completeness, the behavior of the other alkali halides on electrolysis will be briefly described.

Fluorine decomposes water with the evolution of oxygen and ozone:

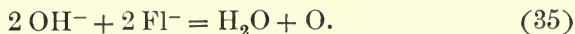

No oxygen compounds of fluorine are known, consequently the electrolysis of fluorides offers nothing to compare with what is obtained in the case of chlorides.

Bromine enters into exactly similar equilibria when added to alkali hydrate to those already described in the case of chlorine. They are represented by the equations:¹

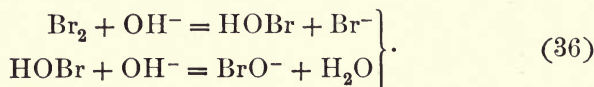

Hypobromite is therefore always the first product of the reaction when bromine acts on alkali hydrate. When one mole of bromine acts on one equivalent of hydrate, the reaction is not as complete as in the case of chlorine, but appreciable quantities of bromine and hydrate remain unchanged.

The formation of bromate according to the equation



takes place with over 100 times the velocity of the corresponding reaction for chlorate. This reaction takes place even in slightly alkaline solutions with a high velocity, on account of the greater hydrolysis of hypobromite, but in solutions that are at least 0.1 normal with respect to hydrate, the hydrolysis has been so far reduced that hypobromite is as stable as hypochlorite. When a concentration of the hydrate is still further increased, the rate at which bromate is produced increases, probably according to the reaction:

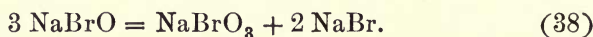

This differs from the corresponding reaction for chlorate, in that it proceeds with scarcely any evolution of oxygen. This reaction, however, is very much slower than that represented by equation (37), and need not be considered in the practical preparation of bromate.

In electrolyzing a bromide solution, free bromine is liberated on the anode, accompanied by oxygen from the discharge of hydroxyl ions, and produces hypobromite with the hydrate formed at the cathode. The concentration of the hypobromite increases up to a certain point, after which it remains constant, and the only product of the electrolysis is then bromate. As

¹ Horst Kretzschmar, Z. f. Elektroch. 10, 789, (1904).

the hypobromite increases in concentration, the evolution of oxygen also increases, the hydroxyl ions for which are furnished by the hydrolysis of the hypobromite.

Bromate is formed partly by the secondary oxidation of hypobromite by hypobromous acid, which is always present to a certain extent on the anode, and partly by direct oxidation according to the equation :

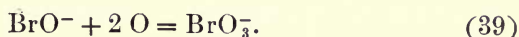

The hypobromite ion is not discharged, so there is no reaction between it and water, as there is in the case of the hypochlorite ion.

The concentration of hypobromite attainable is greatest with a high current density, a high concentration of bromide, and a low temperature. It is also higher on platinized anodes than on smooth, as is the case with hypochlorite. The highest concentration of hypobromite attainable is about the same as that of hypochlorite, but the current yield is less, on account of the greater tendency to form bromate. Unless potassium chromate is added to the solution, bromate, as well as hypobromite, is subject to reduction on a smooth platinum cathode,² which is another point of difference between chlorate and bromate.

Perbromic acid and its salts cannot be produced by electrolysis, and it is doubtful whether they exist at all.³

When iodine is brought in contact with hydrate, the equilibria

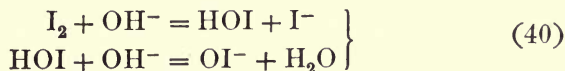

are established exactly as in the case of chlorine and bromine.⁴ Hypoiodite is very considerably hydrolyzed, and therefore, unless the solution is very alkaline, it changes rapidly to iodate by the reaction :

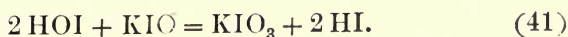

² H. Pauli, *Z. f. Elektroch.* **3**, 474, (1897).

³ Roscoe and Schorlemmer, *Treatise on Chemistry*, **1**, 358, (1905).

⁴ Foerster and K. Gyr, *Z. f. Elektroch.* **9**, 1, (1903).

If an excess of alkali is present, however, the hydrolysis is driven back, and hypiodite can be obtained free from iodate. The formation of iodate is accelerated by an increase in the temperature and concentration of the iodide, and by decreasing the alkalinity.

The rapidity with which hypiodite changes to iodate is shown by the following facts: If 50 cubic centimeters of a 0.1 normal iodine solution are mixed with 50 cubic centimeters of a normal sodium hydrate solution at zero degrees, a 0.05 normal hypiodite solution would be 100 per cent yield. Immediately after mixing, however, there is only 95 per cent of this amount of hypiodite, and after 2 minutes, only 75 per cent remains. On dilution it is more stable; a 0.01 normal hypiodite solution remains practically unchanged for a few minutes in a 0.1 normal alkaline solution at room temperature.

On electrolyzing a neutral solution of alkali iodide,⁵ the iodine liberated on the anode comes in contact with the hydrate from the cathode, and the first product is hypiodite. This changes over to iodate rapidly, as shown above, even in an alkaline solution, so that the electrolysis of an alkali iodide solution is similar to that of a slightly acid chloride solution. Consequently the hypiodite solution reaches a limiting concentration, after which the product of the electrolysis is exclusively iodate. This limiting concentration of hypiodite is determined by the current density, temperature, and the concentration of iodide and alkali. An increase in the alkalinity increases the limiting concentration of the hypiodite, while it decreases that of the hypochlorite. This is due to the different ways in which iodate and chlorate are formed in alkaline solutions.

As the hypiodite never can become concentrated, the possibility of the electrolytic discharge of the hypiodite ion is very small. Therefore the oxygen evolution, which takes place only when the iodide is dilute and the solution is alkaline, must be due nearly entirely to the discharge of hydroxyl ions. It is therefore in no way connected with the formation of iodate.

⁵ Foerster and Gyr, *Z. f. Elektroch.* 9, 215, (1903).

Periodates cannot be produced by the electrolysis of iodates except with a diaphragm.⁶ This is shown by the fact that without a diaphragm no hydrogen is evolved on electrolysis, but is all used in reducing the iodate. After electrolysis has proceeded a while, the oxygen evolution also becomes zero. There is then a constant amount of iodide and iodate in the solution; as fast as iodate is formed on the anode, it is reduced on the cathode. In neutral solutions iodate is not oxidized to periodate, and in alkaline solutions, potassium chromate does not prevent the reduction of iodate to iodide.

By using a diaphragm, a current yield in periodate of about 26 per cent can be obtained. The best conditions are low temperature, low-current density, and at least 4 per cent alkalinity.

2. TECHNICAL CELLS FOR HYPOCHLORITE, CHLORATE, HYDRATE, AND CHLORINE

Hypochlorite. — Hermite's cell, patented in 1887, was the first cell to be even moderately successful for the electrolytic manufacture of hypochlorite.¹ It consisted of a rectangular box of ceramic with a grooved channel around the top for carrying off the solution of sodium and magnesium chlorides, which entered at the bottom. The cathode consisted of numerous disks of zinc supported on two slowly rotating shafts running through the box and separated from each other by a partition. The anodes, consisting of thin sheets of platinum held on a nonconducting frame, were placed between the zinc disks. In practice this cell

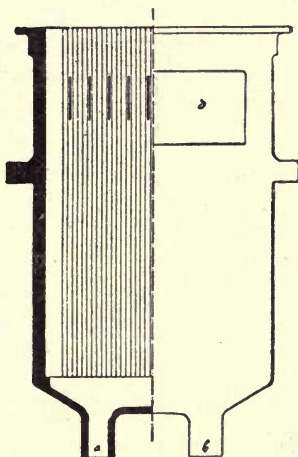

FIG. 33. — Elevation of Kellner cell

⁶ E. Müller, *Z. f. Elektroch.*, 7, 509, (1901).

¹ W. H. Walker, *Electroch. Ind.* 1, 440, (1903); Engelhardt, *Hypochlorite and Elektrische Bleiche*, p. 77, (1903).

gives a current yield of about 40 per cent and an energy yield of one kilogram of chlorine for twelve kilowatt hours.²

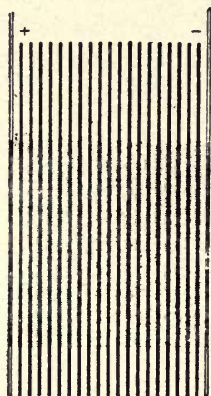

FIG. 34. — Electrodes of Kellner cell

The Kellner cell, made by the Siemens and Halske Company, is shown in Figures 33, 34, and 35. A glazed stoneware vessel is divided into a number of compartments by glass plates fitted into grooves in the sides of the cell. The plates are wound with platinum-iridium wire, which acts as intermediate electrodes, forming the anodes on one side and the cathode on the other side of the glass plates.

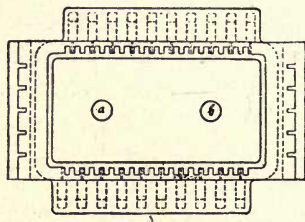

FIG. 35. — Plan of Kellner cell

The solution enters through holes in the bottom of the cell and the electrolyzed solution flows out spouts at the

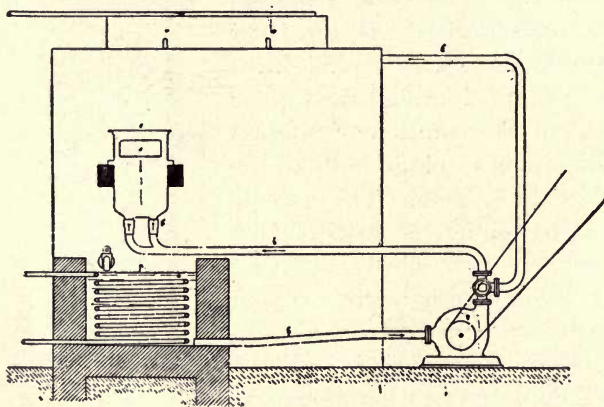

FIG. 36. — Kellner cell

top into a vessel containing a cooling coil. From here it is pumped up through the cell again. This circulation continues

² Engelhardt, *l.c.* p. 86.

until the desired strength of hypochlorite has been obtained. This is illustrated in Figure 36.

The Schuckert cell is also made by the Siemens and Halske Company. It is made of stoneware and is divided into eight

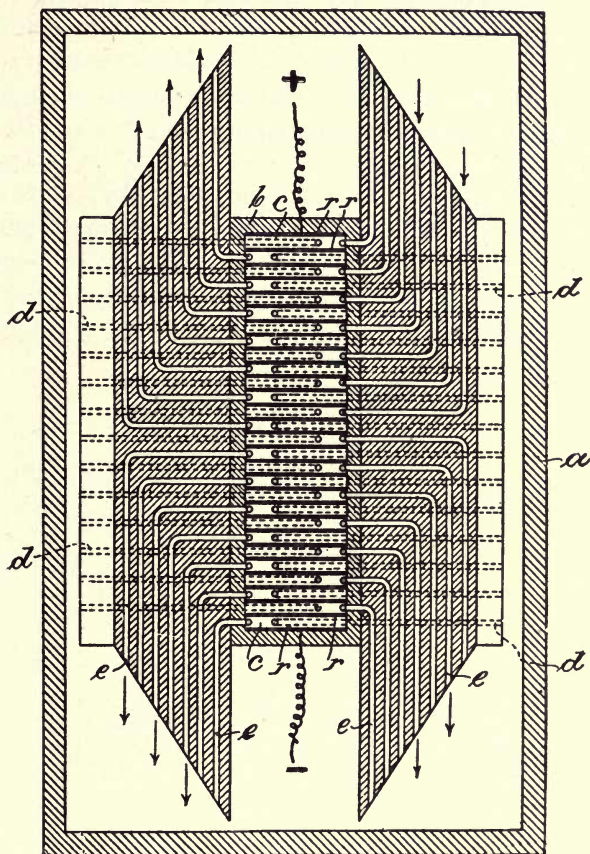

FIG. 37. — Horizontal section of Haas and Oettel cell

or ten compartments, each having two graphite cathodes and a Pt-Ir foil anode. The solution enters at one end and travels in a zigzag direction through the different compartments. Each cell has a cooling coil, and no pumps are needed for circulation. The units are built in pairs and are designed for 110 volts.

The Haas and Oettel cell is shown in horizontal and vertical cross sections in Figures 37 and 38.³ The electrolyzer *b* is immersed in the solution in the storage vessel *a*. The electrolyzer consists of a vessel divided into several compartments *c* by divisions *r*, made of carbon or any suitable material, and forming the intermediate electrodes. The liquid enters the electrolyzer through the passage *d*, one of which leads into each compartment. As soon as the current is turned on, gas is produced in each compartment, which rises and, carrying the liquid with it, causes it to flow through the channels *e*, as shown by the arrows. This automatic circulation is very efficient. A cooling coil in the container prevents the temperature from rising too high. The electrolysis is continued till the concentration of the hypochlorite has reached the desired value.

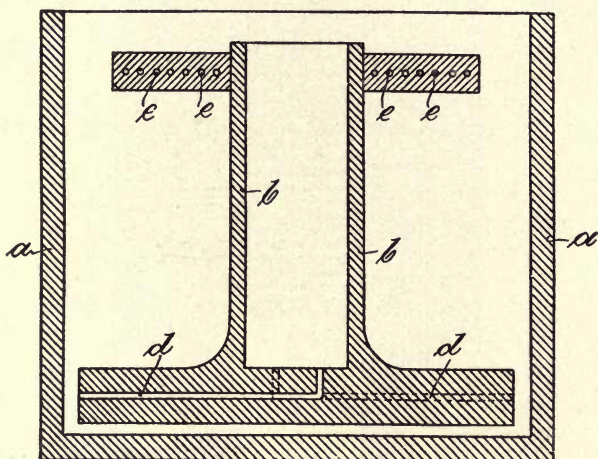

FIG. 38.— Vertical section of Haas and Oettel cell

This cell was never put on the market in this country in the form shown,⁴ but an improved cell is made by the National Laundry Machinery Company of Dayton, Ohio, the details of which are not now available.

Among a number of other factors, the cost of the production

³ U. S. Pat. 718,249, (1903).

⁴ Communication from the National Laundry Machinery Company.

of hypochlorite depends on the cost of salt and of power, and on the concentration of the hypochlorite produced; for, as was shown above, the current efficiency of the production of hypochlorite approaches zero as the concentration increases. For cotton bleaching the hypochlorite is diluted to three grams of active chlorine per liter, and is discarded after using.⁵ Less salt will therefore be lost if as much as possible is changed to hypochlorite, but the cost of power increases as the concentration increases. The concentration to which it will be most economical to continue the electrolysis will therefore depend on the relative cost of power and of salt, assuming all other conditions of the experiment constant. There will then be a concentration of hypochlorite for which the cost will be a minimum, assuming a definite cost for the salt and the power. This minimum cost is found by plotting as ordinates the cost

TABLE 15
The Kellner Cell

ORIGINAL NaCl CONC. KG. PER 100 L.	AMPERES PER CELL	GRM. ACTIVE Cl ₂ PER L.	PER CENT CURRENT YIELD	KW. HR. PER KG. ACTIVE Cl ₂	KG. SALT PER KG. ACTIVE Cl ₂
6.3	120	1.84	77.8	5.9	34.2
6.3	120	3.34	68.8	6.7	18.9
6.3	120	7.06	61.8	7.4	8.9
6.3	120	10.01	44.5	10.3	6.3
10.0	137	3.09	81.5	5.2	32.4
10.0	137	6.85	68.6	6.2	14.6
10.0	137	10.44	58.2	7.3	9.6
10.0	137	12.96	45.9	9.2	7.7
15.0	126	3.00	82.3	5.1	50.0
15.0	126	6.28	73.0	5.7	23.9
15.0	126	10.50	65.3	6.4	14.3
15.0	126	13.50	54.2	7.7	11.1
20.0	130	2.48	90.1	4.5	80.7
20.0	130	6.58	78.0	5.2	30.4
20.0	130	10.09	70.0	5.8	19.8

⁵ W. H. Walker, Trans. Am. Electrochem. Soc. 9, 23, (1906).

of power for a definite amount of hypochlorite at different concentrations, and also as ordinates the cost of the salt required for the different concentrations of hypochlorite. The curve representing the sum of these costs will be found to have a minimum value.

Table 15 gives some data on the yield of active chlorine in the Kellner cell, taken from cells in actual operation.⁶

The yields of active chlorine in the Haas and Oettel apparatus are given in Table 16.⁷

TABLE 16
The Haas and Oettel Cell

GRM. ACTIVE Cl ₂ PER L.	PER CENT CURRENT YIELD	KW. HR. PER KG. ACTIVE Cl ₂	KG. SALT PER KG. ACTIVE Cl ₂
2.55	95.0	3.31	66.6
4.59	82.4	3.82	37.0
8.82	64.8	4.85	19.3
12.30	56.7	5.54	13.8
14.31	52.8	5.96	11.9

The yields in active chlorine for the Schuckert cell are given in Table 17.¹

TABLE 17
The Schuckert Cell

ORIGINAL NaCl CONC. PER CENT	GRM. ACTIVE Cl ₂ PER L.	KW. HR. PER KG. ACTIVE Cl ₂	KG. SALT PER KG. ACTIVE Cl ₂
10	10-22	7	5- 5.3
10	16	6	6- 6.5
10	10-12	5	10-10.6
15	20-22	5.5-6	7.5- 8
15	10-12	4.5-5	15-16

⁶ Englehardt, *l.c.* p. 158.

⁷ Oettel, *Z. f. Elektroch.* 7, 315, (1900).

Chlorate Cells. — Since chlorate is made directly from hypochlorite, a chlorate cell would not be expected to differ from a hypochlorite cell in any mechanical details. The earlier chlorate cells, however, contained a diaphragm, and the cathode solution was allowed to circulate to the anode compartment. This was to prevent the reduction of the hypochlorite from which the chlorate is produced; but since the discovery of the action of potassium chromate, reduction can be avoided without a diaphragm.

The first process to be used in practice was that of Gall and Montlaur, patented in 1884.⁸ This cell originally contained a diaphragm to prevent reduction, and the solution circulated from the cathode to the anode by means of external pipes. The solution must, of course, leave the anode compartment as rapidly as it flows in, but whether it leaves the cell entirely or returns to the cathode compartment is not stated. Since 1897 the diaphragms have been given up. A plant employing this process was put in operation at Vallorbe in 1891, and another in St. Michel, Savoy, in 1896. Very little information concerning these plants has been published.

In 1892 the National Electrolytic Company at Niagara Falls employed the chlorate cell of W. T. Gibbs.⁹ A number of these cells clamped together are shown in Figure 39, and a side elevation of one cell on the line 22 of the preceding figure, in Figure 40.¹⁰ Each cell consists of a frame *A* made of wood with a metallic resistant lining *B*. The rods *C* forming the cathode are attached on one side of this frame, and on the other, the anode, consisting of a metallic plate *D* faced with platinum *E*. Copper is preferred for the cathode and lead for the plate *D*. Successive frames are separated from each other by gaskets *F*. *G* are supply tubes and *H* are vents for the escape of gas and liquid. The cells are clamped together by the plates *JK* and the bolts *L*. Each pair of electrodes is separated by the corresponding gasket. The horizontal insulating rods *O* prevent

⁸ J. B. C. Kershaw, *Die Elektrolytische Chloratindustrie*, p. 19, (1905).

⁹ J. W. Richards, *Electrochem. Ind.* 1, 19, (1902).

¹⁰ U. S. Pat. 665,426, (1901).

short circuit between the anodes and cathodes, which are only from 1 to 3 millimeters apart. The electrolyte circulates from the cell to a cooling vessel where the chlorate is precipitated.

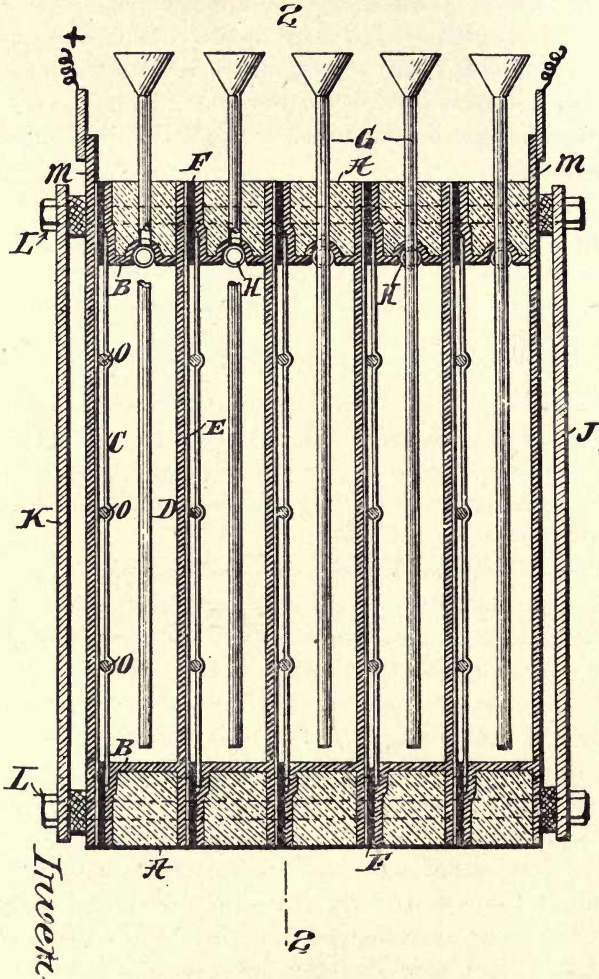

FIG. 39. — Gibb's cells clamped together

More chloride is then added, and the solution is returned to the electrolyzing cell. A convenient size for these cells is 65 by 45 centimeters and 7.5 centimeters thick.

The cell of Lederlin and Corbin, used at Chedde, is of the open type.¹¹ It contains a platinum anode and two cathodes of copper, bronze, brass, or iron. The anode has an area of 10 square centimeters and the cathode, 32.

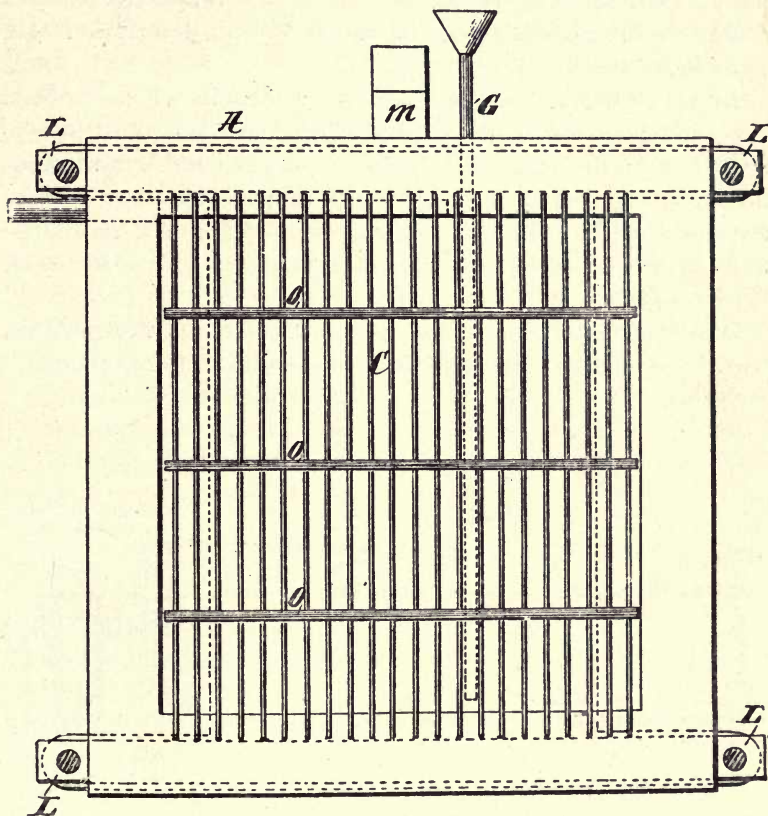

FIG. 40. — Section of single Gibb's cell

The chlorate is generally purified by recrystallization, and the recrystallizing apparatus is an important part of a chlorate plant.

The yield at Vallorbe was at first 55.9 grams per kilowatt hour, though this has since been considerably increased.¹²

¹¹ Kershaw, *l.c.* p. 38.

¹² Kershaw, *l.c.* p. 63.

partment, containing the anode. The diaphragms consist of asbestos paper fastened to asbestos cloth by sodium silicate, and are held in position by cement placed over both end walls and the bottom of the anode compartment. This compartment is closed by a cast-iron cover 5 inches deep, 6 inches wide, and nearly 5 feet long, into which the anodes are cemented. It is lined with cement and painted inside with asbestos varnish.

The anode consists of blocks of graphitized carbon, 4 inches square and 10 inches long, into each of which a copper rod is fastened by lead for the electrical connection. The partition walls form the cathode.

The partition walls are flanged, forming a seat to hold the cover, which is surrounded by a layer of cement. The chlorine is conducted from the anode compartment by a lead pipe to a gas main which leads to absorbing towers containing lime-water. Brine circulates through the anode compartment.

The diaphragms last about 8 months,¹⁵ after which time the pores become clogged.

The sodium hydrate solution leaving the cathode compartment contains from 7 to 18 per cent sodium hydrate. When the diaphragm is new, the level of the liquid in the anode and cathode compartments is nearly the same, but when it becomes more or less stopped up, the depth of the liquid in the cathode compartment is only an inch or two.

The Hargreaves-Bird cell consists of a cast-iron box 10 feet in length, 14 inches in width, and 5 feet in height.¹⁶ It is divided into three compartments by two diaphragms made on heavy copper gauze, which forms the cathode. The space between the diaphragms is the anode compartment, through which brine circulates. There is no liquid in the anode compartment except what percolates through the diaphragm. Steam and carbonic gas are blown through the two outer compartments and change the hydrate formed on the outside of the diaphragm to sodium carbonate. This cell takes 2000 amperes at from 4 to 4.5 volts. The anode is a row of gas carbons,

¹⁵ L. Rostosky, *Z. f. Elektroch.* **11**, 21, (1905).

¹⁶ *Electrochem. and Met. Ind.* **3**, 350, (1905).

which last 30 to 40 days. The diaphragms last about the same length of time.

The Hargreaves-Bird cell is shown in Figure 42, which is a partial longitudinal section and side elevation, and in Figure 43, which is a section perpendicular to the length.¹⁷ The outside frame *l* is of iron lined with cement and bricks *m*, which are saturated with tar to prevent leakage. The space

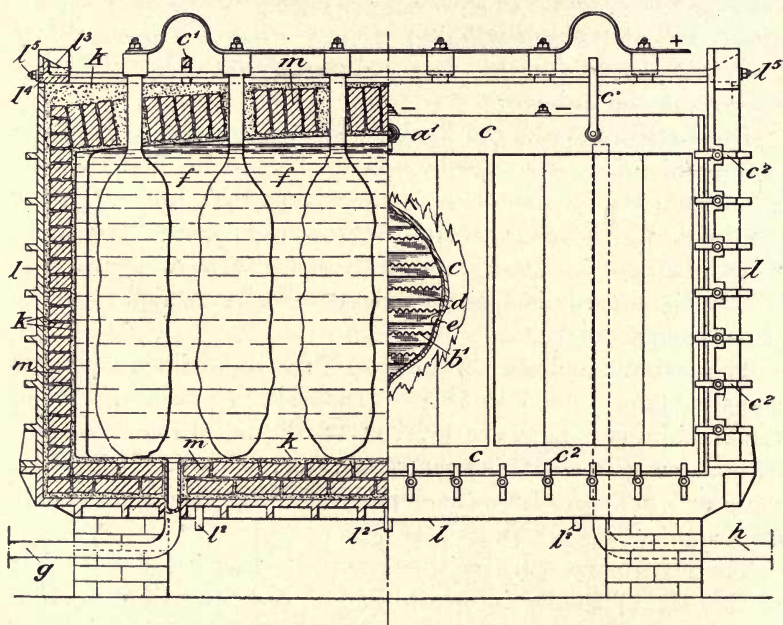

FIG. 42. — Hargreaves-Bird cell, side elevation

f is the anode compartment through which the chloride solution circulates, entering through the pipe *g* and leaving through *h*. The diaphragms are made of asbestos paper, the pores of which have been filled with hydrated silicate of lime or magnesia.¹⁸ In the cathode chamber a number of copper strips *b* are placed, imbedded in cement *e*, extending from the cover plate *c* to the cathode *d*, and inclined downwards. These direct the con-

¹⁷ U. S. Pat. 655,343, (1900).

¹⁸ U. S. Pat. 596,157, (1897).

densed vapor against the cathode to wash away the alkali as it is formed. The lower edges of the strips have openings, in order to allow the steam and gas to pass freely over the cathode. a', a' are the injectors for supplying carbonic acid gas and steam to the cathode chambers. l^2, l^2 are pipes for draining the cathode chambers. The chlorine passes from the anode chambers to the towers, where it is absorbed by milk of lime.

The West Virginia Pulp and Paper Company, Mechanicsville, New York, use this cell for making their bleaching solutions.¹⁹ This plant consists of two rows of 14 cells each, all connected in series.

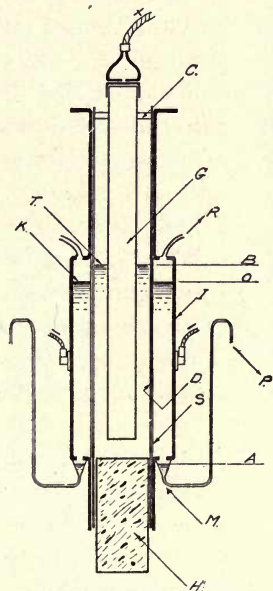

FIG. 44. — Townsend cell

close contact with the diaphragms. These plates are fastened to two iron sides I , which form the cathode compartment. The anode compartment is filled with brine T , and the cathode com-

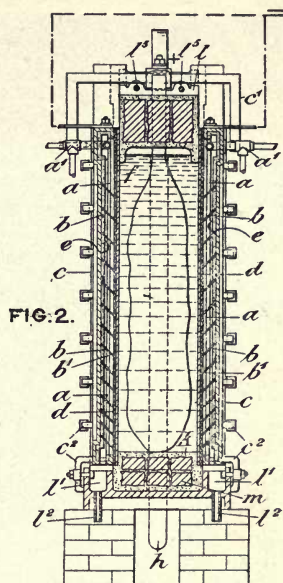

FIG. 43. — Hargreaves-Bird cell, end section

Perhaps the most efficient diaphragm cell in use is the Townsend cell, represented in cross section in Figure 44, and in perspective in Figure 45.²⁰ The anode space is inclosed between a lid C , two vertical diaphragms D , and a non-conducting body H . Graphite anodes pass through the lid on the cell. The perforated iron cathode plates S are in

¹⁹ Electrochem. and Met. Ind. 6, 227, (1908).

²⁰ Electrochem. and Met. Ind. 5, 209, (1907).

partment with kerosene oil *K*. The brine percolates through the diaphragm, and, when the current is turned on, it contains

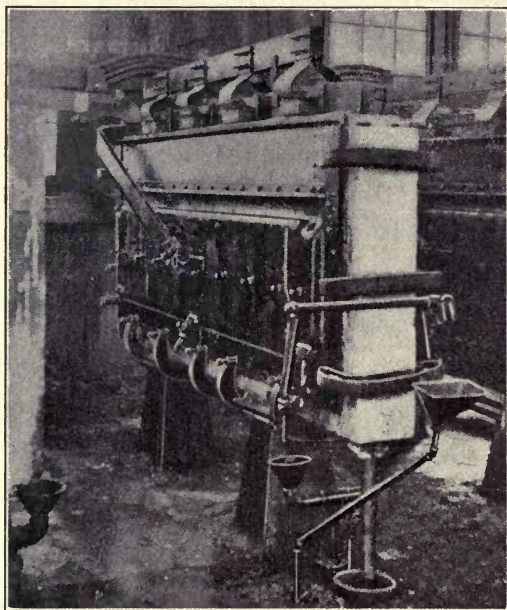

FIG. 45. — Townsend cell

hydrate. The aqueous solution, on passing the diaphragm, comes in contact with the kerosene and forms drops which fall to the bottom of the compartment, are collected in the pocket *A*, and are drained off through *P*. The solution leaving *P* contains 150 grams of sodium hydrate and 213 grams of salt per liter. The salt is separated by evaporation and is used over again.

The continual percolation prevents nearly all diffusion of hydrate back to the anode. The rate of percolation for a 2500-ampere cell is from 15 to 30 liters an hour.²¹

The Townsend cell is 8 feet in length, 3 feet in depth, and 1 foot in width, and consists of a U-shaped concrete body against which the two iron side plates are clamped. A rubber gasket is placed between the concrete and the iron to make a tight joint. Brine circulates through the anode compartment, and during its passage the specific gravity falls from 1.2 to 1.18. On leaving the cell it is resaturated and is then ready to be passed through again. There is a loss in kerosene which amounts in cost to about two dollars a day for a large plant.

The diaphragms of the Townsend cell consist of a woven

²¹ Baekeland, *Electrochem. and Met. Ind.* 7, 314, (1909).

sheet of asbestos cloth, the pores of which are filled with a mixture of iron oxide, asbestos fiber, and colloid iron hydroxide. This mixture is applied with a brush like ordinary paint. Diaphragms may be renovated by scrubbing and washing the surface with water, allowing to dry, and repainting with this mixture. This operation is not necessary more than once in five weeks, and sometimes not for several months.

The current efficiency of the Townsend cell is as high as 96 or 97 per cent under ordinary conditions, with a current density on the anode of 1 ampere per square inch and about 4 volts on each cell.²² This cell has been in use at Niagara Falls in the plant of the Development and Funding Company since 1906. This plant originally consumed 1000 kilowatts, and according to latest accounts it was being increased to four times this capacity.²¹

Not much information concerning the bell process as actually arranged in practice is available. The process is carried out by the Oesterreiche Verein für Chemische und Metallurgische Production in Aussig, and at several places in Germany. Figure 46 shows

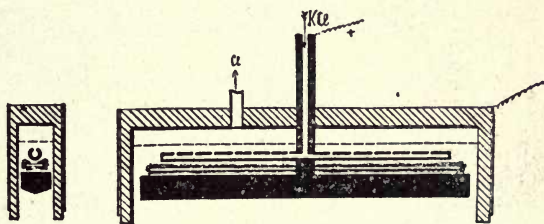

FIG. 46. — Cell for Bell process

two cross sections of the cell, 25 of which are placed side by side in each bath.²³ The solution leaving the bath is said to contain 100 to 150 grams of alkali hydrate per liter, at a current yield of 85 to 90 per cent and with 4 to 4.5 volts per cell.²⁴

The Castner cell²⁵ is represented in Figure 30. It is a slate box 4 feet square, and 6 inches deep, the joints of which are

²² For laboratory tests on the efficiency of this cell, see Richardson and Patterson, *Trans. Am. Electrochem. Soc.* **7**, 311, (1910).

²³ *Z. f. Elektroch.* **7**, 925, (1901).

²⁴ Haeussermann, *Dinglers polyt. J.* **315**, 475, (1900).

²⁵ U. S. Pat. 528,322, (1894).

made tight with rubber cement.²⁶ Two partitions, reaching to within $\frac{1}{16}$ inch of the bottom, divide the cell into three compartments. The two outside compartments contain the graphite anodes *A*, and the middle compartment, the iron cathode *C*. Brine circulates through the anode compartments, and pure water is supplied to the cathode compartment. The cell is pivoted on two points at one end and the other is raised and lowered

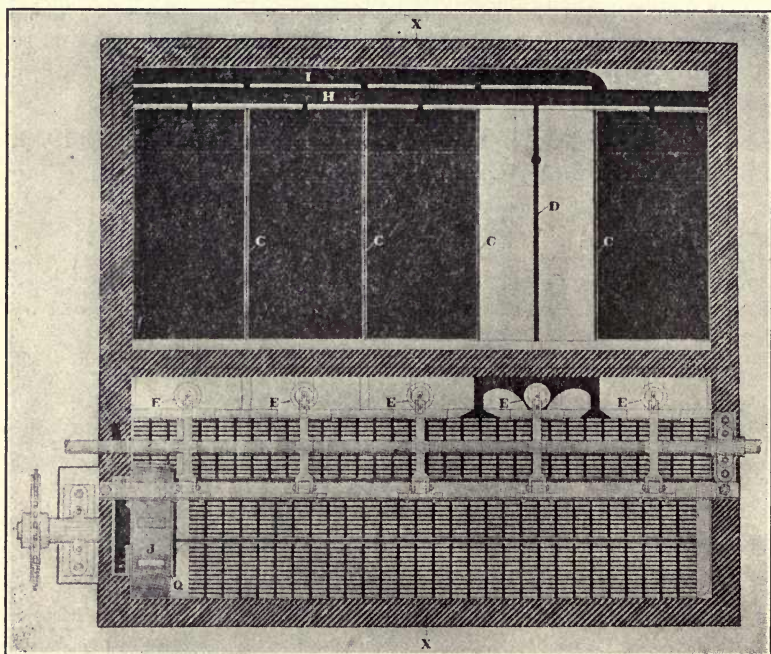

FIG. 47. — Whiting electrolytic cell, plan

about $\frac{1}{2}$ inch once a minute, causing the mercury to circulate between the anode and cathode compartments. The hydrate leaving the cathode compartment has a specific gravity of 1.27. This is evaporated to solid hydrate in large iron pans. Each cell takes about 100 pounds of mercury, which is a very large item of expense. The current for each cell is 630 amperes at 4.3 volts, and the current efficiency is about 90 per cent.

²⁶ J. W. Richards, *Electrochem. Ind.* 1, 12, (1902).

The Whiting mercury cell is²⁷ of a different type from the Castner cell. The sodium is not electrolyzed out of the amalgam, but the amalgam is withdrawn from the electrolyzing chamber and treated with water in a decomposing chamber where the hydrate is formed. A number of electrolytic compartments are placed in parallel and are operated successively,

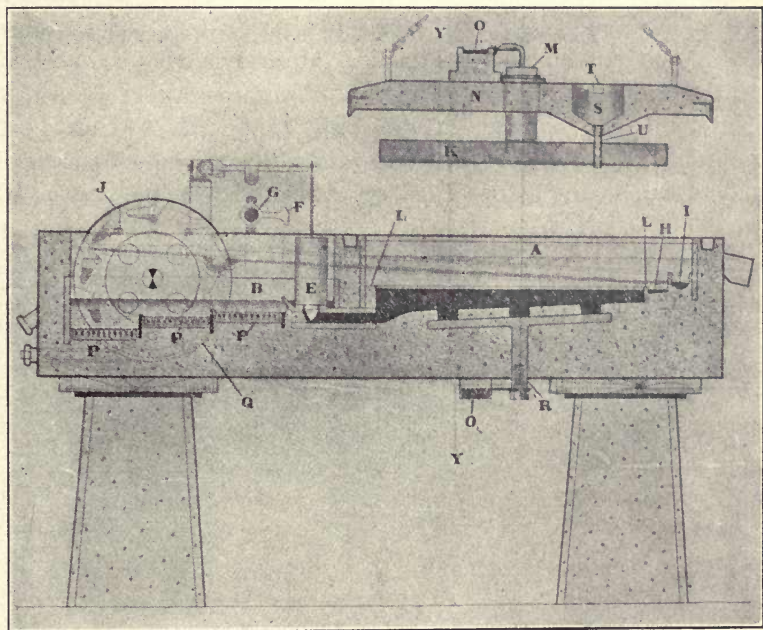

FIG. 48. — Whiting electrolytic cell, cross section

so that the cell is continuous in its action, though intermittent in principle.

This cell, shown in Figures 47, 48, and 49, is a massive concrete structure supported on four concrete pedestals, from which it is insulated. It consists of a shallow box divided into two compartments, *A* and *B*, by a concrete partition. The bottom of the decomposing chamber is divided by low glass partitions into a number of sections having V-shaped bottoms

²⁷ Jasper Whiting, *Trans. Am. Electrochem. Soc.* **17**, 327, (1910).

sloping at a slight angle towards the central slot *D*. These slots lead through the concrete partition into the oxidizing chamber *B*, where they turn upward and are closed by valves *E*. The valves are operated by the cams *F*, which are attached to a slowly revolving shaft *G*. The other ends of the slots are connected by the channel *H*, called the distributing level. This connects with a secondary channel *I*, which leads through one of the side walls of the cell to a pump *J*, at the extreme end of the oxidizing compartment. Mercury covers the bottom of the decomposing compartment, filling the above-described sections to a common level. The anodes *K* are slabs of Acheson graphite, perforated to allow the chlorine to escape, and rest upon the ledges *L*, placed at the ends of the section in

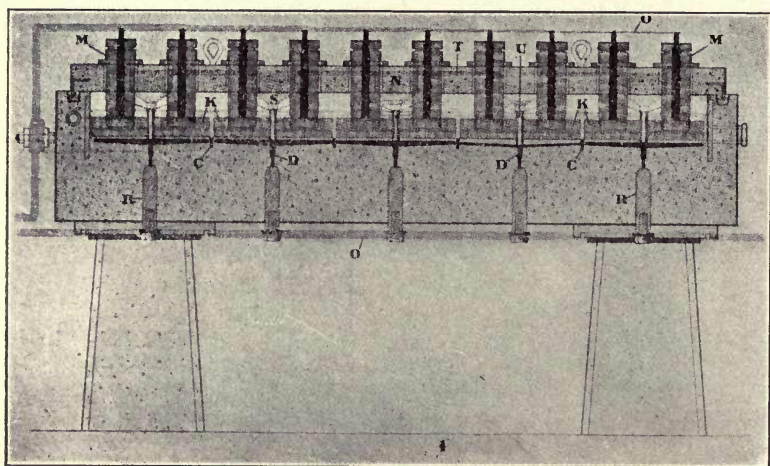

FIG. 49. — Whiting electrolytic cell, longitudinal section

such a way as to make a very short distance between the anode and the mercury cathode. The anodes are connected to the dynamo by the leads *M*.

The oxidizing chamber is divided into three compartments *P*, lined with graphite and sloping downward in successively opposite directions, forming a zigzag path to the pump pit *Q*, where the stoneware rotary pump *J* is placed. Brine fills the

decomposing chamber, and water or alkali hydrate fills the oxidizing chamber.

The action is as follows : The floor of several sections of the decomposing chamber is covered with mercury, maintained at a common level by the distributing level. The current flows from the anode through the brine to the mercury and out by the iron rods *R*, partly imbedded in the concrete. When the electrolysis has proceeded about two minutes, the valve at the point of exit of one of the sections is opened by the action of the cam, and the entire mass of sodium amalgam in the section sinks into the slot and through the connecting pipe into the oxidizing chamber. When the mercury is out of the cell, the valve is closed by the cam. Mercury free from sodium then flows into the empty chamber by way of the distributing level, until the common level is reached. In the meantime the sodium amalgam in the oxidizing chamber flows by gravity over the graphite plates *P* to the pump pit. On reaching this point the mercury has been deprived of its sodium, and is raised by the pump into the wall pipe of the decomposing chamber, completing the cycle.

The brine is fed in between the electrodes from the receptacles *S*, equal in number to the sections of the decomposing chamber. They are formed in the cover of the decomposing compartment, and are connected by a channel *T*. Glass tubes lead from the bottom of the receptacle *S* through the anode and terminate below the surface of the mercury near the middle of each section. As long as the sections are filled with mercury the lower ends of the tubes are sealed, but when the mercury is drawn off, a definite quantity of concentrated brine flows into the section.

The graphite slabs in the oxidizing chamber contain a large number of channels through which the mercury flows. The sides of the channels extend into the caustic solution and form the cathode of a short-circuited couple. It is difficult to maintain good contact between the graphite and mercury on account of the hydrogen evolved, but this difficulty was overcome by boring holes $\frac{1}{2}$ inch deep and $\frac{1}{8}$ inch in diameter at frequent

intervals in the channels, and filling them with pure mercury at the start. This mercury remains pure and makes good contact with the amalgam and the graphite.

The cell used at the Oxford Paper Company's works in Rumford, Maine, is 1.8 meter square. It consists of five sections and takes a current of from 1200 to 1400 amperes at 4 volts. This corresponds to an anode current density of 11 amperes per square decimeter. The current efficiency is from 90 to 95 per cent. The temperature is about 40 degrees. Each cell requires from 350 to 375 pounds of mercury. A 20 per cent hydrate solution is obtained, though one with 49 per cent can be made if desired. The chlorine gas is 98 per cent pure, the remaining 2 per cent being hydrogen.

CHAPTER VII

THE ELECTROLYSIS OF WATER

HYDROGEN and oxygen have a number of technical applications that require their manufacture on a large scale. Such uses are welding with the oxyhydrogen flame, as is done in joining the lead plates of storage batteries; hydrogen is used for filling balloons, and oxygen is used for chemical and medicinal purposes.

Hydrogen and oxygen are produced on a commercial scale by the electrolysis of aqueous solutions, and of course the object of the large number of patents taken out in this field is to keep the hydrogen and oxygen separate from each other. For this purpose the anode and cathode compartments have to be separated by a partition of some kind. The different methods of separating the gases will be illustrated in the description of the following cells.

The cell designed by Dr. O. Schmidt¹ is shown in sections in Figures 50-53, and a general view in Figure 54. It consists

¹ Engelhardt, *Die Elektrolyse des Wassers*, p. 24, (1902); *Z. f. Elektroch.* **7**, 294, (1901).

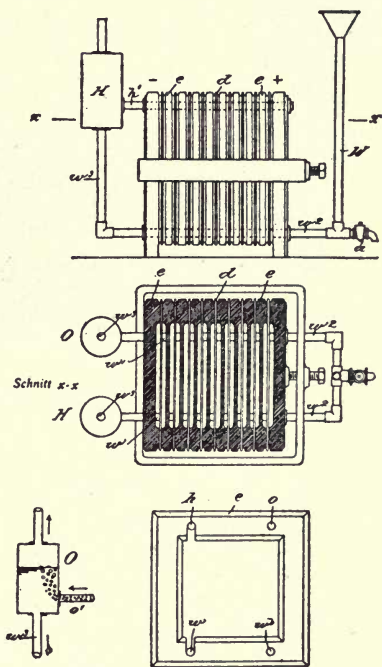

Figs. 50-53.—Schmidt's apparatus for the electrolysis of water

of a number of iron plates e having thick rims and separated by diaphragms d . These plates are the cathode in one cell and the anode of the following cell. Each plate has two holes in the thick rims h, o and w, w' , so that the apparatus is traversed above and below by two canals. The lower canals are for supplying the water as it is decomposed, and the upper are for al-

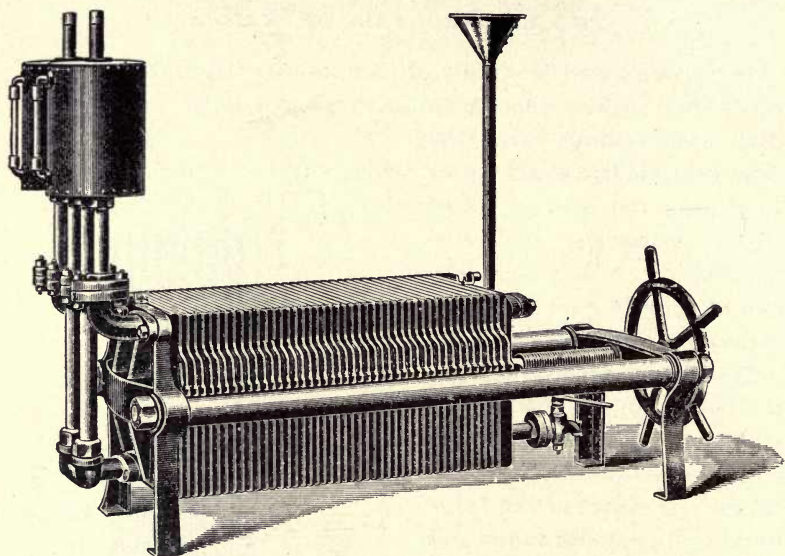

FIG. 54. — Schmidt's apparatus for the electrolysis of water

lowing the gases to escape. The canals w and h connect with the cathode chambers, w' and o with the anode chambers. The two canals for adding water, w and w' , are connected with a common filling tube W by the pipes w^2, w'^2 , and at the other end of the apparatus the two gas canals connect with reservoirs H and O , where the gas is separated from the liquid carried along with it. The liquid then returns to its respective chamber in the electrolyzer. The stopcock a is for emptying the apparatus.

The diaphragms are of asbestos with rubber edges to prevent leakage. The electrolyte is a dilute solution of potassium carbonate. Each cell has 2.5 volts impressed, and the current yield is nearly 100 per cent. The oxygen is on the average

97 per cent pure, while the hydrogen is 99 per cent. Either gas may be purified by passing through red-hot porcelain tubes,

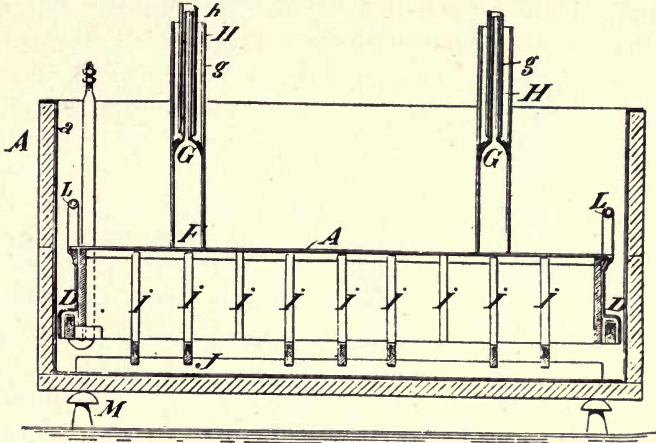

FIG. 55. — Garuti and Pompili's electrolyzer

which combines the small impurity of hydrogen in the oxygen, or of oxygen in the hydrogen, to water which is easily removed.

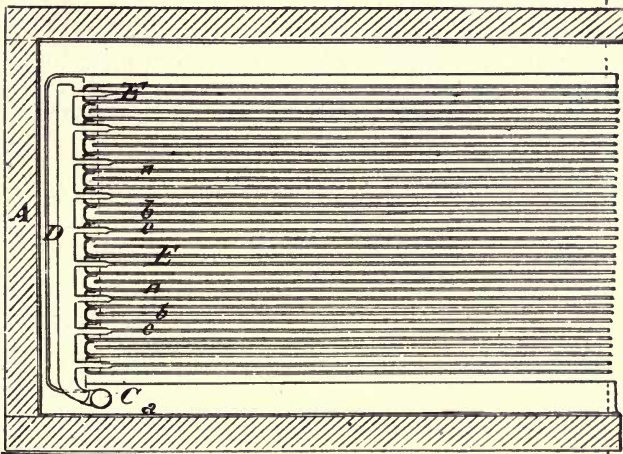

FIG. 56. — Garuti and Pompili's electrolyzer

This apparatus is made at the Maschinenfabrik Oerlikon, near Zürich, Switzerland.

An apparatus in which the separation of the hydrogen and oxygen is effected by a different method is that of Garuti and Pompili.² In this cell a partition of iron separates the anode from the cathode, and this partition is prevented from becoming an intermediate electrode

by keeping the voltage applied to the cell too low for this to take place. The current flows from the anode to the cathode around the bottom of the iron partition.

Figure 55 is a longitudinal vertical section through the center, Figure 56 is a horizontal section of one end, Figure 57 is a vertical cross section of the apparatus, and Figure 58 a plan view of conductor and electrodes.

A tank *A* of wood lined with iron *a* contains the electrolyzer, which consists of an inverted tank *A'* which is divided into cells *E* by longitudinal diaphragms. This cell is made of iron and is open only at the bottom. The anodes *b* and cathodes *c* are placed one in each cell, taking care that each anode is between two cathodes.

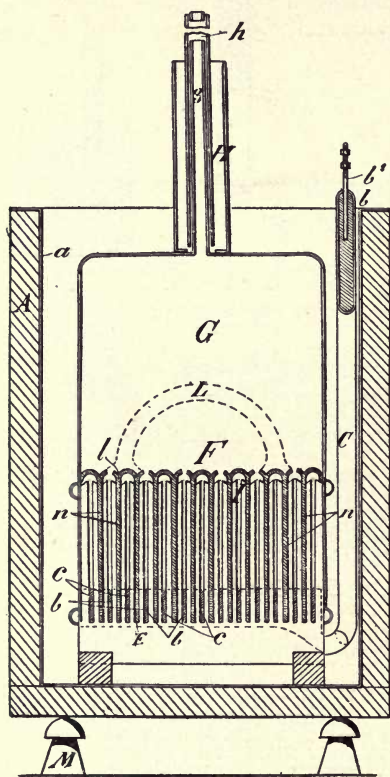

FIG. 57. — Garuti and Pompili's electrolyzer

The gas passes through an opening at the top of each chamber into the reservoir containing the same gas. The electrodes are insulated from the diaphragms by combs *I* made of wood, the teeth of which enter the cells and fill the spaces between the electrodes and diaphragm. *L* is a handle for lifting out the electrolyzer.

² U. S. Patent 629,070, (1899).

A 25 per cent solution of potassium hydrate is used. The voltage per cell is not allowed to exceed 3 volts, so there is no danger of the diaphragm acting as an electrode. The diaphragms may be perforated near the bottom with a large number of small holes, as there is very little danger of the gases becoming mixed at this point.

The hydrogen obtained from this apparatus is 98.9 per cent pure, the oxygen 97. This apparatus is used in Rome, Tivoli, Brussels, and Lucern.

The cell of the Siemens Brothers and Company and Obach³ employs a partition which consists of metal gauze below the water line. The current is conducted through the meshes, which are small enough to prevent the mixture of the gases.

Other cells, such as that of Schoop,⁴ have nonconducting partitions.

These examples complete the different principles on which technical cells for the decomposition of water are built.

³ Engelhardt, *l.c.* p. 67.

⁴ Engelhardt, *l.c.* p. 44.

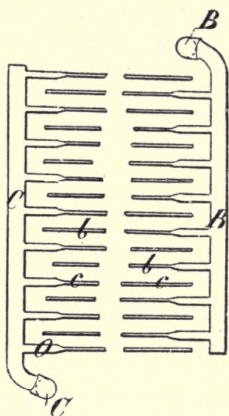

FIG. 58. — Garuti and Pompili's electrolyzer

CHAPTER VIII

PRIMARY CELLS

A PRIMARY battery is a cell so arranged that the energy of a chemical reaction is obtained as an electric current, and in which the chemicals are not regenerated by passing the current through the cell in the opposite direction. When the battery is run down, fresh chemicals must be supplied. A secondary battery, or accumulator, is a battery in which chemicals are regenerated by passing through the cell, after discharge, a reverse current from some other source.

Before the invention of dynamos, primary batteries were the main source of electric energy; but since this method of generating electricity is too expensive for use where a large quantity of energy is needed, they were employed only for very light work and for experimental purposes. They are still used extensively for electric bells, for exploding the gases in engines by electric sparks, railroad signals, and similar purposes. Primary batteries of special forms are also the standards of electromotive force, but this is rather a purely scientific branch of the subject than a technical application, and will therefore be omitted.

The first primary battery was due to Volta, and consisted in a negative pole of zinc and a positive pole of copper dipping into a solution of salt or dilute acid. The electromotive force of this battery rapidly falls off if an appreciable current is taken from it, on account of the hydrogen liberated on the positive pole. This develops a back electromotive force and also increases the resistance of the cell itself. The battery is then said to be polarized. In order to have a battery that is at

all efficient, polarization must be avoided. In the Smee cell, this was done by substituting platinized silver for the positive pole in place of the copper in the Volta cell. The rough surface caused the bubbles of hydrogen to escape more rapidly. In the Grove battery, devised in 1831,¹ the cathode consisted of platinum dipping into nitric acid contained in a porous cup. Outside the cup was dilute sulphuric acid and a zinc negative pole. In this case the nitric acid acts as a depolarizer, oxidizing the hydrogen to water and itself being reduced to nitrous gases. The electromotive force of this battery is between 1.6 and 1.7 volts.

The Bunsen cell is a Grove cell with carbon in place of platinum for the positive pole.

In the chromic acid battery, due to Poggendorff, the electrolyte is a solution of sulphuric acid and potassium bichromate. The positive pole is carbon and the negative zinc, which is withdrawn from the battery when not in use. The chromic acid acts as depolarizer. The electromotive force is about 1.3 volts.

These batteries have at present little more than historical interest. The use of primary cells is now nearly entirely confined to the Leclanché, the Lalande, and the Daniell cells. Leclanché brought out his cell in 1868.² It consists of a zinc rod forming the negative pole and dipping into a solution of ammonium chloride. The positive pole is carbon in contact with manganese dioxide for a depolarizer. When the circuit is closed, zinc goes in solution as zinc chloride and the ammonium radical is deposited on the carbon, which breaks up into ammonia and hydrogen. The ammonia dissolves and the hydrogen is oxidized by the manganese dioxide to water. This depolarization is not rapid, however, consequently not much current can be taken from a Leclanché cell at a time without the voltage dropping considerably, but it recovers on standing. The electromotive force of this cell on open circuit differs from one cell to another, varying from 1.05 to 1.8 volts.

This cell is put on the market under a large number of different

¹ Wiedemann, *Die Lehre von der Elektrizität*, 1, 867, (1893).

² Wiedemann, *l.c.* p. 850.

forms and under different names. One of the best Leclanché cells on the market is the Sampson cell.³ The carbon of this cell is shown upside down in Figure 59. It consists of a fluted hollow cylinder of French carbon provided with a removable seal at the lower end and filled with a mixture of carbon and manganese dioxide. The cell set up is shown in Figure 60.

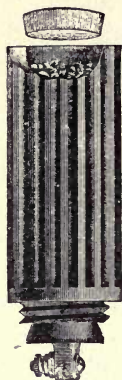

FIG. 59. — Carbon of Sampson cell

The Lalande cell, brought out in 1883,⁴ consists of zinc for the negative pole, a 30 per cent solution of potassium hydrate for the electrolyte, and a plate or box of iron or copper in contact with black copper oxide as depolarizer. The hydrate is protected from the carbonic acid of the air by a layer of oil. The zinc goes in solution as sodium zincate, and the hydrogen deposited on the positive plate is oxidized by the copper oxide. The positive plate may also be an agglomerate porous plate of copper oxide. The electromotive force of this cell is about 0.9 volt and is very constant. The oxide when reduced to copper is easily oxidized again by heating in the air. The original method of Lalande of making the porous copper oxide plates was to press a moist mixture of oxide, 4 or 5 per cent clay, and 6 to 8 per cent tar, and then to heat to redness. The plates so produced were porous and lasted well. This plate must be reduced to copper over its entire surface before its normal rate is reached, on account of the poor conductivity of copper oxide. This is done before assembling the plates.

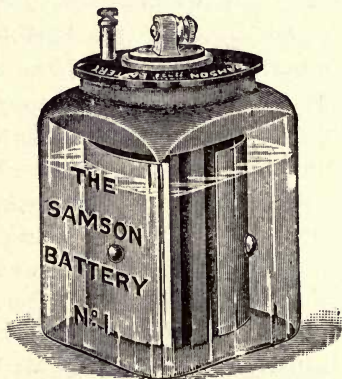

FIG. 60. — The Sampson cell

A modern type of the Lalande battery is made by the Edison

³ N. H. Sneider, *Modern Primary Batteries*, p. 10, (1905).

⁴ Wiedemann, *l.c.* p. 854.

Manufacturing Company at Orange, New Jersey, and is called the Edison-Lalande Battery. This battery, shown in Figure 61, consists of a copper oxide plate between two zinc plates dipping in a 20 or 25 per cent solution of sodium hydroxide. The containing jar is porcelain. The zinc plates have mercury added to them during casting, so that they are amalgamated throughout. The copper oxide plates are made from copper scale which is finely ground and then roasted until thoroughly oxidized. The oxidized powder is then moistened with a solution of sodium hydroxide and pressed into cakes a little larger than desired in the finished product. These cakes are then dried and baked at a bright red temperature, which partially welds the particles together. After cooling, the plates are reduced to copper at the surface by zinc dust, to make them conduct. They are then washed and are ready for use.⁵ The hydroxide solution is covered with a heavy mineral oil to prevent its creeping up the zinc plates and corroding them. This battery has an initial electromotive force of 0.95 volt, but on continuous discharge at normal rate it drops to about 0.6 volt. The capacity varies from 100 to 600 ampere hours, depending on the size of the battery.

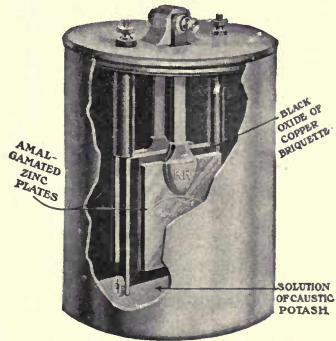

FIG. 61. — Edison Lalande battery

The Daniell cell, brought out in 1836,⁶ belongs to a different class of cells, in which there are two liquids separated by a porous partition. The positive pole is copper dipping in a concentrated solution of copper sulphate, and the negative is zinc dipping in sulphuric acid. Copper is deposited on the positive in place of hydrogen, thus avoiding polarization, and zinc goes in solution forming zinc sulphate. The electromotive force of this cell is about 1.1 volt.

The gravity cell, Figure 62, is a form of the Daniell cell

⁵ Private communication from the company.

⁶ Wiedemann, *l.c.* p. 859.

patented by Varley in 1854, but which did not become generally known until 1884. It is now the principal commercial form of the Daniell cell.⁷ The gravity cell derives its name from the way in which the two solutions are prevented from mixing. At the bottom of a glass jar is a horizontal copper electrode

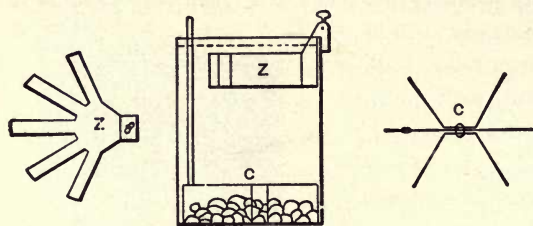

FIG. 62. — The gravity cell

covered with copper sulphate crystals and a saturated solution of copper sulphate. On this solution is carefully poured a dilute sulphuric acid solution, in which a horizontal zinc electrode is immersed. When in use the migration of the copper ions towards the cathode prevents their reaching the zinc, while if the cell stands on open circuit the copper sulphate would finally reach the zinc by diffusion and cover it with a layer of copper. This cell should therefore always be kept on a closed circuit through a few ohms resistance.

Dry cells are a type of primary battery that have recently come into very general use. It is estimated that 50 million a year are manufactured in the United States, a large majority of which are of a standard size, cylindrical in shape, 15 centimeters long and 6.25 centimeters in diameter.⁸ They are essentially Leclanché cells with a very small quantity of electrolyte. Their greatest field of usefulness is probably telephony and next the ignition through spark coils.⁹

The container or outside insulation is usually pasteboard, sometimes waterproofed by paraffine or pitch. Just inside of the container is the cylindrical zinc negative pole, usually 15 centimeters high, 6.25 in diameter, and 0.3 to 0.55 millimeters thick. Lining the zinc on the inside is a layer of a special grade of pulp board, moistened with a solution of zinc and

⁷ Schneider, *l.c.* p. 54.

⁸ D. L. Ordway, *Trans. Am. Electrochem. Soc.* **17**, 341, (1910).

⁹ Burgess and Hambuechen, *Trans. Am. Electrochem. Soc.* **16**, 97, (1909).

ammonium chlorides. The zinc chloride is added for reducing the local action. Inside the pulp board containing the electrolyte are placed the depolarizer and the positive pole. The depolarizer is manganese dioxide, mixed with carbon, graphite, or a mixture of both. Graphite is used to give the cell a lower resistance. A carbon rod at the center and surrounded by this mixture is the positive pole. An average composition of this filling mixture is the following:⁹

- 10 parts of manganese dioxide,
- 10 parts of carbon or graphite, or both,
- 2 parts of ammonium chloride,
- 1 part of zinc chloride.

Sufficient water is added to give a proper amount of electrolyte to the cell, depending on the original dryness of the materials, their fineness, the quality of the paper lining, and similar factors. The usual specifications for the manganese dioxide are that it shall contain 85 per cent of the dioxide and less than 1 per cent of iron. The cell is sealed up on top with a pitch composition to hold in the filling material and to prevent the cell from drying. The carbon rod extends above the seal and is provided with a binding screw.

The electromotive force of this cell is between 1.5 and 1.6 volts. On a short circuit through an ammeter, a cell will give from 18 to 25 amperes. The energy output of a cell of the dimensions given above, discharged to 0.2 volt continuously, varies from about 20 watt hours when discharged through 2 ohms to 57 watt hours when discharged through 40 ohms.⁸

The primary cells described above are comparatively unimportant compared with one which is not yet realized, but on which a great deal of time and work has been spent. This is the cell in which carbon and oxygen are the elements consumed. The present method of producing work by the combustion of coal to run steam engines is very inefficient, as only about 15 per cent of this energy is obtained as work, the rest being lost as heat. If it were possible to devise a cell in which carbon and oxygen would unite with the production of an

electric current and no other form of energy, at ordinary temperature, a much greater amount of energy could be obtained.

In order to calculate¹⁰ the free energy, or energy that is obtainable as useful work, of the reaction in question,

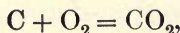

consider a reaction chamber, as shown in Figure 63, containing carbon, oxygen, carbon monoxide, and carbon dioxide in equi-

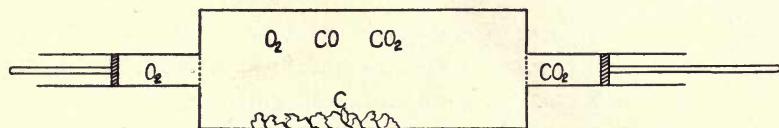

FIG. 63. — Reaction chamber

librium at a given temperature. The chamber has two pistons separated from it by semipermeable membranes. The semipermeable membrane at the end of the cylinder containing oxygen is permeable to oxygen only, and that at the end of the cylinder containing carbon dioxide is permeable only to carbon dioxide. The maximum work that this reaction can produce is then obtained by the following reversible process: one mole of oxygen is admitted to the oxygen cylinder at atmospheric pressure and is allowed to expand reversibly to the equilibrium pressure of oxygen p_{O_2} in the reaction chamber. The work produced is

$$W_1 = RT \log \frac{1}{p_{\text{O}_2}}.$$

The oxygen is then forced into the reaction chamber through the semipermeable membrane. In order to preserve equilibrium, one mole of carbon dioxide must be simultaneously withdrawn at the equilibrium pressure p_{CO_2} into the carbon dioxide cylinder. The work produced in these two steps is evidently zero. The carbon dioxide must then be compressed to atmospheric pressure, in which step the work produced is

$$W_2 = RT \log \frac{p_{\text{CO}_2}}{1}.$$

¹⁰ Nernst, *Theoretische Chemie*, 6th ed. p. 698, (1909).

The sum of W_1 and W_2 is the maximum work obtainable :

$$W_1 + W_2 = RT \log \frac{p_{\text{CO}_2}}{p_{\text{O}_2}}. \quad (1)$$

It would be impossible to measure the pressure of oxygen in this mixture directly, but its value at 1000° C. can be obtained as follows: It has been found experimentally that at 1000° C. carbon dioxide dissociates to 0.06 per cent, according to the reaction :

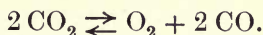

At a total pressure of one atmosphere, the equilibrium pressures for this system are then :

Carbon dioxide	0.9991 atmosphere
Carbon monoxide	0.0006 atmosphere
Oxygen	0.0003 atmosphere

Substituting in the equation for the mass action law,

$$K(p_{\text{CO}_2})^2 = p_{\text{O}_2} (p_{\text{CO}})^2, \quad (2)$$

$$K(1)^2 = (0.0003)(0.0006)^2. \quad (3)$$

It has also been found that at 1000° C. and atmospheric pressure an equilibrium mixture of carbon monoxide and dioxide in the presence of carbon has the following pressures :

Carbon monoxide	0.993 atmosphere
Carbon dioxide	0.007 atmosphere

Since K is known from equation (3), the pressure of oxygen in this system can be computed by substituting in equation (2) :

$$K(0.007)^2 = x(0.993)^2.$$

From this, $x = 5.4 \times 10^{-15}$ atmosphere.

Substituting in equation (1),

$$\begin{aligned} W_1 + W_2 &= 1273 R \log \frac{0.007}{5.4 \times 10^{-15}} \\ &= 70600 \text{ calories at } 1000^\circ \text{C.} \end{aligned}$$

This gives the free energy of the reaction at 1000° C., and it may be found at room temperature as follows: The heat of the reaction at room temperature is $Q = 97650$ calories, and it would be approximately the same at the absolute zero, on account of

the small change in the heat capacity of carbon and oxygen before and after uniting. This would also be the free energy at the absolute zero, since free energy and the total energy of a reaction are equal at this temperature. The free energy at the absolute temperatures 1273° and 0° being known, it may be interpolated for 20° by the formula,

$$W_1 + W_2 = 97650 - \frac{97650 - 70600}{1273} \times 293 \\ = 91470 \text{ calories at } 20^\circ \text{C.}$$

The ratio of the free to the total energy is therefore approximately $\frac{91}{97}$, corresponding to 94 per cent.

If the carbon of the carbon electrode enters the electrolyte as an ion with four positive charges, and the oxygen as an ion with two negative charges, the electromotive force of this cell would be found from the equation,

$$4EF = 91000 \text{ calories ;}$$

from which $E = \frac{91000}{4 \times 23100} = 0.99 \text{ volt.}$

The difficulties in realizing this cell consist in finding an electrolyte in which carbon will dissolve, and in making an oxygen electrode. So far they have been insuperable, and at present there seems very little prospect of success.

Attention has been called by Ostwald¹¹ to an important point in this cell, that the carbon and oxygen must form the opposite poles of the cell and must act on each other through an intervening electrolyte. If the carbon and oxygen acted directly on each other, local action would result, and no current would be produced.

A number of attempts have been made to make a carbon oxygen cell, all of which employed some fused salt or hydrate as electrolyte. This is a disadvantage to start with, for energy will be lost by radiation in keeping the cells at a temperature of several hundred degrees centigrade. One of the first of these attempts was made by Jablochhoff¹² in 1877. In this cell the

¹¹ Z. f. Elektroch. 1, 122, (1894).

¹² E. de Fodor, Elektrizität direkt aus Kohle, p. 41, (1897).

carbon was dipped into melted potassium nitrate, and the positive electrode was iron. This cell could never be successful, for the carbon is brought directly in contact with the oxidizing substance. Also, the oxygen was not taken directly from the air, but was in the expensive form of a nitrate.

In 1896, W. W. Jacques patented a cell which excited a good deal of interest at that time. This consisted of an iron pot containing a melted mixture of potassium and sodium hydrate, into which a carbon rod dipped; air was blown against the iron pot, which formed the positive pole, the idea being that this oxygen would combine with the carbon through the intervening electrolyte and produce a current. It is evident that the hydrate would be changed to carbonate and that some method would have to be used to regenerate it. The carbon was in the expensive form of electrodes. There was a certain amount of direct oxidation of the carbon, for the air also came in direct contact with the hot carbon electrode. For these and other reasons this cell has not been a success.

In conclusion, it may be said that the chance of finding any solvent in which carbon would dissolve as ions is very remote, and to find one in which both oxygen and carbon would thus dissolve is still more remote; consequently it seems hardly possible that this problem will be solved by such a direct method.

CHAPTER IX

THE LEAD STORAGE BATTERY

1. HISTORY AND CONSTRUCTION

THE lead storage battery in the charged state consists of a positive plate of lead peroxide and a negative plate of finely divided lead, both dipping in sulphuric acid of about 1.2 specific gravity. When discharged, the surface of both plates has been changed to lead sulphate. The plates may be brought back to their original condition by sending a current through the battery in the reverse direction.

This battery was invented in 1860 by Gaston Planté.¹ The original battery consisted of two lead plates separated by flannel and rolled together, and immersed in sulphuric acid. The flannel was soon replaced by thin strips of rubber, on account of its being eaten away by the acid. The battery was charged from two Bunsen elements in opposite directions six or eight times on the first day, allowing the cell to discharge itself between each change in direction of charging. It was noticed that the period of discharge continued to increase regularly. The period during which the battery was submitted to the action of the current in the same direction was then increased, and the battery was allowed to rest for eight days, after which it was charged in the opposite direction. The period of rest was then extended to two weeks, one month, two months, and so on, and the duration of discharge continued to increase. When sufficient capacity was reached, the plates

¹ Gaston Planté, *The Storage of Electrical Energy*, p. 30, (1887).

were considered formed, and the charging current was then always sent through the cell in the same direction. The reason a thick layer of peroxide cannot be produced in one charge is that it conducts the current and prevents the lead below it from being attacked.

It is evident that this method of formation would be very expensive. To overcome this difficulty, Metzger and Faure, independently and approximately simultaneously, devised methods of applying the active material to the plate in the form of lead oxides. This method was patented by Faure² in 1880, and has since been known by his name. Faure's original method of applying the oxides was to coat the plate with a paste made of the material and to hold it in place by means of some porous material, such as felt or asbestos paper.

Charles F. Brush of Cleveland applied for a patent covering this same field about a month before Faure, and the patent was finally awarded to him. Eventually all of the essential patents were acquired by the Electric Storage Battery Company of Philadelphia.³

The two general methods of making storage battery plates now in use are only modifications of the original Planté or Faure process.

The Planté process includes all methods in which the active material is made from the plate itself, which must be of pure soft lead.⁴ Formation is accelerated in a number of ways. Usually the first operation is to work up the surface mechanically by cutting grooves, unless it is cast in this form. The next operation is to produce the necessary amount of active material. This is frequently done by allowing the plates to stand for a certain time in some corroding solution of acids that produces a thick layer of lead sulphate. This may then be reduced electrolytically to lead or oxidized to lead peroxide. The acids other than sulphuric must be thoroughly washed out before the battery is ready for use. For example, a mixture of nitric and

² U. S. Patents 252,002, (1882) and 309,939, (1884).

³ Watson, Storage Batteries, p. 10, (1908).

⁴ Watson, *l.c.* p. 21.

sulphuric acids would have this effect of producing a layer of sulphate. The other method of rapid Planté formation is entirely electrolytic, according to the following principle :

The plate is electrolyzed as an anode, but lead peroxide, which would protect the plate from further action, is prevented from forming by adding some salt or acid to the solution, the anion of which separates at a lower potential than the peroxide ion and causes the production of sulphate. Lead sulphate does not conduct, so the current has to penetrate to the lead below, and as much sulphate may be produced in one step as is desired. Such additions are acetates, tartrates, chlorides, nitrates, chlorates, perchlorates, and the corresponding acids.

Peroxide is not always formed on a lead anode in sulphuric acid, even when no substance is added to the solution to prevent it, as is shown by the fact that the lead plate, which is the anode, on discharging, becomes covered with sulphate. If therefore a lead plate is short circuited in a solution of sulphuric acid with a peroxide plate, it will become covered with sulphate, proportional in amount to the current that flows through the plate.⁵

In the Faure batteries the plates for holding the active material consist of lead with about 5 per cent of antimony. The active material is made by making a paste of lead oxide and sulphuric acid and applying it to grooves cast in the supporting grid. This paste sets and becomes hard, after which it is changed to lead sponge and peroxide by electrolysis in a solution which may, or may not, be sulphuric acid.

The negative plates of the chloride battery, formerly made by the Electric Storage Battery Company of Philadelphia, but given up about eight years ago,⁶ were made in an entirely different way. Lead and zinc chlorides were melted together and poured into the supporting grid. The zinc chloride was then dissolved in water, leaving the lead chloride in a porous condition. This was then reduced to sponge lead electrolytically. The positive plates of this battery were made by the Planté

⁵ Dolezalek, *The Theory of the Lead Accumulator*, p. 194.

⁶ Private communication from the company.

process. Though the method is no longer employed, the name is retained. Figure 64 shows the positive and negative plates of the chloride accumulator

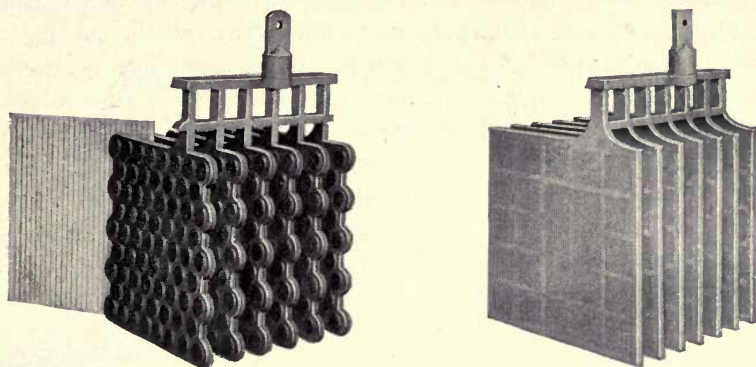

FIG. 64. — Positive and negative plates of the chloride accumulator

of one type of the so-called chloride accumulator. The positive plate contains buttons of lead strips wound up and held in a grid. In the negative plate the active material is held in posi-

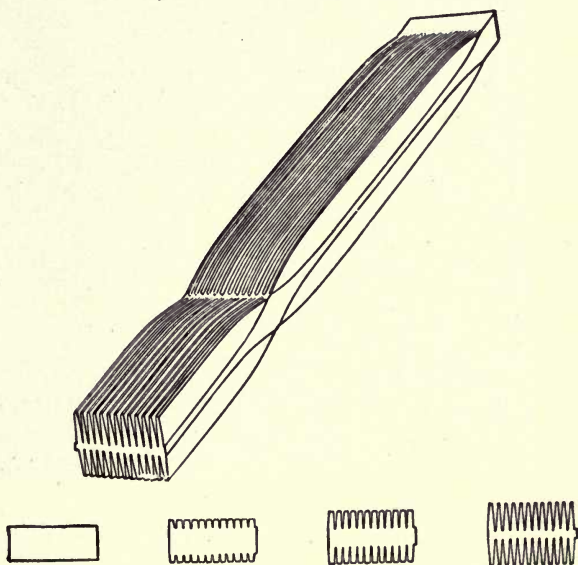

FIG. 65. — The Gould battery plate

tion by perforated sheet lead, while the positive plate is of the Planté type.

In the Gould battery, both plates are made by the Planté method. A pure lead sheet is stamped out, and the surface is worked up into the shape shown in cross section in Figure 65, by rolling the surface a number of times with steel disks. This process is called spinning. An unspun portion of the plate is left where the wheels stop, forming a number of cross-bars in each plate. A thin layer of lead peroxide is then produced by an electrolytic process. Negative plates are made by

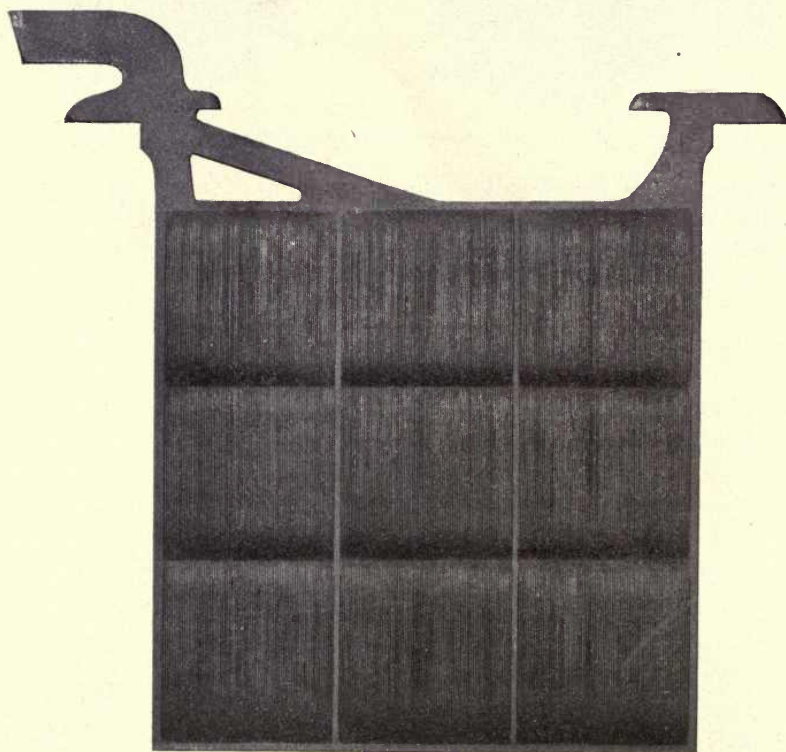

FIG. 66. — Positive Gould plate

reducing peroxide plates.⁷ Figure 66 shows a positive plate ready to be formed.

⁷ Catalogues of the Gould Company.

There are a large number of different types of batteries made by different companies, information concerning which is best obtained from their catalogues.

2. THEORY OF THE LEAD STORAGE BATTERY¹

The theory of the lead storage battery now generally accepted is known as the sulphate theory, and is due to Gladstone and Tribe. According to this theory sulphuric acid combines with the plates on discharge, and is set free on charge. On discharge hydrogen is deposited on the lead peroxide and reduces it to lead oxide, which is changed to lead sulphate. This is represented by the equation:

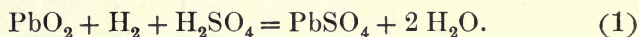

At the same time the sulphate radical is deposited on the lead plate and changes it to lead sulphate:

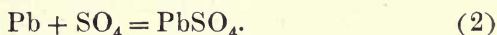

The total change in the storage battery on discharge is the sum of equation (1) and (2):

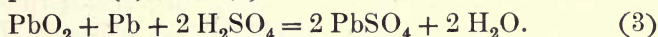

In the discharged state both plates are covered with sulphate.

On charging, the reaction on the positive plate is:

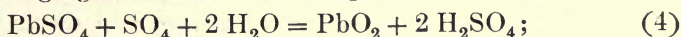

and in the negative plate:



The sum of equations (4) and (5) represents what takes place in the whole battery on charging:

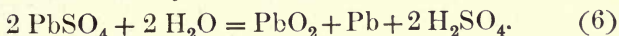

Equation (6) is identical with equation (3) read from right to left. The changes taking place both on discharge and charge may therefore be represented by the following reversible equation:

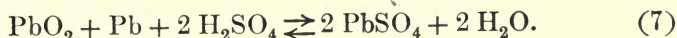

¹ This discussion is taken mainly from Dolezalek's *The Theory of the Lead Accumulator*, translated by Carl L. von Ende. John Wiley and Sons, (1904).

From right to left this represents the discharge, and from right to left the charge.

In order to show that this equation represents what takes place in the lead cell, it is necessary to show that the formation or disappearance of each of the substances involved is proportional to the amount of electricity that has passed. It must also be shown that the substances involved are those given in the equation.

That the charged positive plate is the peroxide of lead and not some other oxide or hydrate was shown by measuring the electromotive force of different lead oxides and hydrates on lead against a zinc electrode and comparing with a charged positive plate. The results were the following :

Pb Pb ₂ O	- Zn = 0.42 volt
Pb PbO	- Zn = 0.46 volt
Pb Pb ₃ O ₄	- Zn = 0.75 volt
Pb H ₂ PbO ₃	- Zn = 0.96 volt
Pb PbO ₂	- Zn = 2.41 volts

A charged positive plate has a potential of 2.4 volts, showing that lead peroxide is the compound that exists on the positive plate.

Gladstone and Tribe showed, by analyzing the active mass of the plates at different stages of charge and discharge, that the production of sulphate on each plate is proportional to the

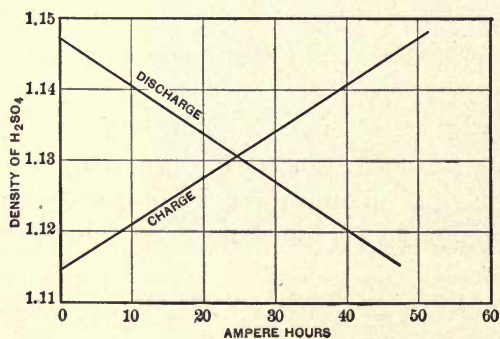

FIG. 67. — Change in density of acid with charge and discharge

quantity of electricity that has been taken from the cell.

The same thing was shown by W. Kohlrausch and C. Heim by measuring the specific gravity of the acid on charge and discharge. The density changed exactly in proportion to the

quantity of electricity that had passed through the cell, as shown in Figure 67. A calculation of the change in specific gravity by means of equation (7) agrees with that found. This calculation is as follows:

The uncharged battery contained 3350 cubic centimeters of acid of 1.115 specific gravity, corresponding to 16.32 per cent acid. The total solution therefore weighed

$$3350 \times 1.115 = 3735 \text{ grams,}$$

and contained

$$0.1632 \times 3735 = 610 \text{ grams of acid,}$$

and therefore 3125 grams of water.

After charging with 50 ampere hours, according to equation (7), the amount of water that disappeared was

$$50 \times 2 \times 0.336 = 33.6 \text{ grams,}$$

and the amount of sulphuric acid formed was

$$33.6 \times \frac{98}{18} = 183 \text{ grams.}$$

The solution therefore contained after charging

$$3125 - 33.6 = 3091.4 \text{ grams of water, and}$$

$$610 + 183 = 793 \text{ grams of sulphuric acid.}$$

The total weight was therefore 3884 grams, and the amount of sulphuric acid contained was $\frac{793}{3884} \times 100 = 20.42$ per cent, corresponding to a density of 1.146. The observed density was 1.147.

In order to see whether the heat of the reaction of equation (7) and the electromotive force of the cell are in agreement, the heat of the reaction may be substituted in the equation:²

$$E = \frac{Q}{23070} + T \frac{\partial E}{\partial T}, \quad (8)$$

when E is the electromotive force and $2Q$ is the heat of the reaction of equation (7). Half of this value is used in equation (8), for $2Q$ corresponds to the amount of material changed by the passage of 2 coulombs of electricity. The value of Q has been measured by Tscheltzow and by Streintz, who found 43,800 calories and 42,800 calories respectively, for

² Le Blanc, *Electrochemistry*, p. 173, (1907).

acid of a density 1.044, corresponding to 0.70 mole of acid per liter. This concentration is taken, since at this value the temperature coefficient of the electromotive force is zero. The values of E computed are

$$E = 1.86 \text{ volts (Streintz),}$$

$$E = 1.90 \text{ volts (Tscheltzow),}$$

and the measured value for this density of acid gives 1.89 to 1.90 volts.

For acid of specific gravity 1.15, the values of Q are 42,600 calories and 43,600 calories respectively, and the value of $\frac{\partial E}{\partial T}$ is $+0.4 \times 10^{-3}$ volt. At 17°C ., $T = 290$. Substituting in equation (8), $E = 1.96$ and 2.01 volts respectively. The measured value is 1.99 to 2.01 volts. This calculation furnishes a conclusive proof that the reaction given in equation (7) is the one that takes place in the lead accumulator.

It is evident that since the acid becomes more dilute on discharging a lead battery, the electromotive force must decrease with decreasing concentration. Table 18 shows the relation between the concentration of the acid and the electromotive force, from direct measurements.

TABLE 18

DENSITY OF H_2SO_4	PER CENT H_2SO_4	ELECTROMOTIVE FORCE AT 15°C .
1.050	7.31	1.906
1.150	20.91	2.010
1.200	27.32	2.051
1.300	39.19	2.142
1.400	50.11	2.330

It will be noticed that the electromotive force of the lead storage battery, with the concentration of acid ordinarily used, has the unusually high value for a battery of over two volts. Sulphuric acid, if electrolyzed between platinum and electrodes, gives a weak evolution of gas at 1.7 volts and at 1.9 a strong evolution. If lead sulphate were spread in platinum, it would therefore not be possible to reduce it to lead and oxidize it to

peroxide, for the potential required could not be reached. On lead, however, the overvoltage is so great that the gas evolution does not take place below 2.3 volts, which is greater than

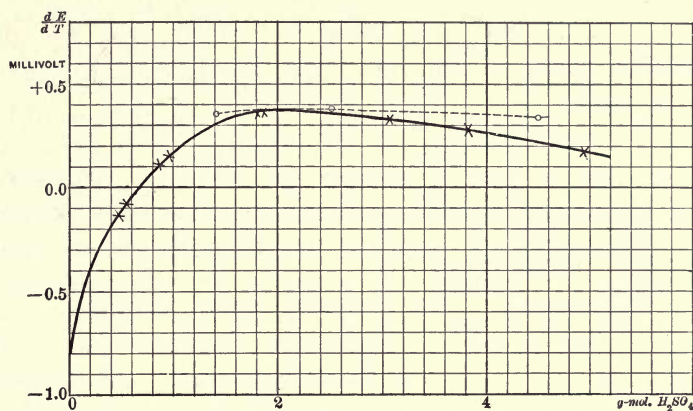

FIG. 68. — Temperature coefficient of electromotive force of lead storage battery as function of the acid concentration

the voltage needed to change the sulphate in lead on one electrode and peroxide on the other. If it were not for this high overvoltage on lead, the lead storage battery would be an impossibility.

The temperature coefficient of the lead storage battery for the concentration of acid used is positive, but on decreasing the concentration of acid the temperature coefficient falls to zero and then becomes negative. This is shown by the curve in Figure 68, representing the results of experiments in which the temperature coefficient was determined between 0° and 24° C. The temperature coefficient is constant in value between 10° and 70° C. The heavy line in the plot gives the experimental results, and the dotted curve the values calculated from equation (8).

The mechanism of the reactions taking place in the lead storage battery has been explained with the help of the osmotic theory by Le Blanc and by Liebenow. The difficulty in applying this theory to the lead storage battery is to know what are the ions in the case of the lead peroxide plate. According to Le

Blanc's theory, the lead peroxide, having a definite, though slight solubility, dissolves in the dilute sulphuric acid and then reacts with water according to the equation:

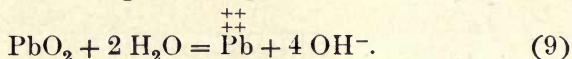

During discharge the tetravalent lead ions give up two charges of electricity and combine with the $\overline{\text{SO}}_4$ ions to form lead sulphate. The tetravalent lead ions are replaced, as they are used up, by the solution of more lead peroxide. There is no loss in free energy in this solution and reaction with water, for both of these reactions take place at equilibrium concentrations. The spongy lead electrode is similar to the zinc in a Daniell cell. It goes in solution as a lead ion, but is precipitated on the lead plate because of the low solubility of lead sulphate. The hydrogen ions of the sulphuric acid combine with hydroxyl ions of equation (9) to form water. The equations representing the reactions that take place subsequent to the reaction of equation (9) for the entire battery are accordingly:

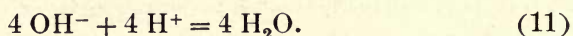
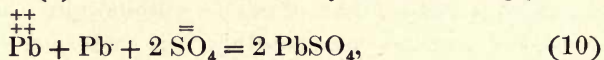

On charge the reverse of the above reactions takes place. Both the positive and negative plates are covered with lead sulphate, and the sulphuric acid surrounding the plates must also be saturated with lead sulphate. On the negative plate the lead ions are deposited as spongy lead, and on the positive plate the bivalent lead ions are oxidized to tetravalent lead. The solution and electrolysis are represented by the equations:

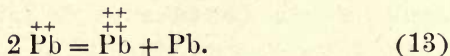
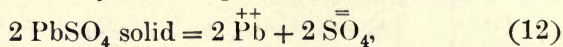

The tetravalent ions then react with the hydroxyl ions according to equation (9) taken in the reverse direction:

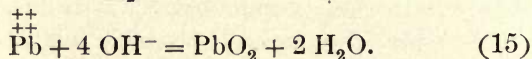
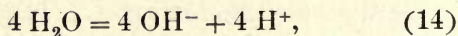

The hydrogen ions corresponding to the hydroxyl ions and the sulphate ions from equations (12) unite to form sulphuric acid :

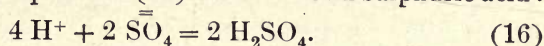

The sum of equations (9) to (11) and of equations (12) to (16) will be found to result in equation (7). In support of Le Blanc's theory it may be stated that tetravalent lead ions do exist, and they are therefore probably capable of forming by the electrolysis of lead sulphate solutions.

Liebenow's theory differs from Le Blanc's only as to the action of the peroxide electrode. According to this theory the lead peroxide goes into solution as doubly charged lead peroxide ions, so that the peroxide plate is to be considered a reversible electrode with respect to the peroxide ions. On discharge, the peroxide passes into the solution surrounding the peroxide plate, which is already saturated with respect to these ions. They then react with the hydrogen ions of the acid as follows :

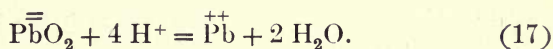

The lead ions then combine with the sulphate ions to form solid lead sulphate :

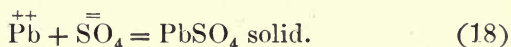

During charge, just the reverse reactions take place. The lead peroxide ions are deposited on the positive plate, and are replaced as they are used up by the solution of the sulphate from the electrode and its hydrolysis :

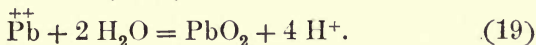

In order to give Liebenow's theory some foundation it is necessary to prove the existence of lead peroxide ions. This was done by showing that on electrolyzing a solution of lead in sodium hydroxide the concentration of the lead in anode compartment increased. This shows that the sodium plumbite must be dissociated according to the equation :

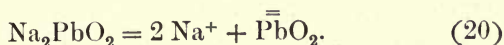

The electromotive force of the lead storage battery can be

expressed by the Nernst formula by the aid of Liebenow's theory. If P_{PbO_2} is the electrolytic solution pressure of lead peroxide and P_{Pb} that of lead, and if the p 's refer to the osmotic pressure of the ions, the potential difference between the peroxide plate and the solution is

$$e_1 = -\frac{RT}{2} \log \frac{P_{\text{PbO}_2}}{p_{\text{PbO}_2}}, \quad (21)$$

and between the lead plate and the solution is

$$e_2 = \frac{RT}{2} \log \frac{P_{\text{Pb}}}{p_{\text{Pb}^{++}}}. \quad (22)$$

The electromotive force of the cell is therefore

$$E = e_1 + e_2 = \frac{RT}{2} \log \frac{P_{\text{PbO}_2} \cdot P_{\text{Pb}}}{p_{\text{PbO}_2} \cdot p_{\text{Pb}^{++}}}. \quad (23)$$

In confirmation of this theory, it has been found, as would be predicted from equation (23), that in an alkaline solution, in which the concentrations of the lead and lead peroxide would be greater than in acid solutions, the value of E is less than in acid solutions.

The work obtainable from a storage battery depends on its capacity and the electromotive force measured at its poles while the current is flowing. If V is the voltage on charging, E is the open circuit electromotive force, I is the charging current, and R is the resistance of the battery, then

$$V = E + IR, \quad (24)$$

and on discharge

$$V' = E - IR. \quad (25)$$

If the current is kept constant and the value of V is measured at short intervals, the charge and discharge curves obtained are of the form shown in Figure 69. The value of V rises rapidly in the first few minutes of the charge from 2.0 to 2.1 volts, and during the rest of the charge continues to rise slowly, until at the end it suddenly rises to 2.5 to 2.7 volts. During this period of rapid rise in the value of V , the cell begins to evolve gas, after which the value of V changes only slightly. On allowing the battery to stand on open circuit

for several hours, the electromotive force E falls to the value corresponding to the density of the acid. If the battery is then allowed to discharge with the same constant value of the current as used in charging, the value of V' at first falls rapidly

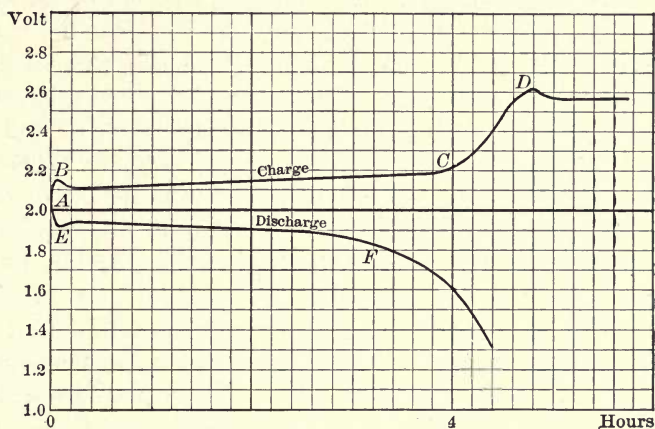

FIG. 69. — Charge and discharge curves of the lead storage battery

to 1.9 volts and then gradually to 1.85 volts, after which it decreases more rapidly to zero. The curves given in Figure 69 were obtained with about 20 per cent acid and a current density of about 0.005 ampere per square centimeter of electrode surface. With a greater current density the distance between the charge and discharge curves would increase. The general character of the curves for different makes of batteries is the same, though for those having a thin layer of active material the curves are more marked, and for those having a thick layer, they are more rounded.

From the fact that the charging potential V is several tenths of a volt higher than the discharging potential V' , as is shown in Figure 69, it is evident there is a loss of from 20 to 30 per cent in the energy stored. It might seem at first sight that it is due to the loss of energy due to the resistance of the cell itself, to the IR value in equations (21) and (22), but the value of the resistance of the cell is too small to account for such a large loss. On open circuit the resistance of the

smallest cells used is only several hundredths of an ohm, and no large increase in its value takes place when a current is passing. The cause of this loss in energy is the polarization of the electrodes caused by the change in concentration of the acid in the pores of the plates. On charging, acid is formed in the pores of the plates where it becomes more concentrated than in the rest of the battery on account of the fact that diffusion does not take place with sufficient rapidity to equalize it. Since the electromotive force of the battery increases with the concentration of the acid surrounding the plates, a higher impressed electromotive force will therefore be necessary in charging. On discharge, the acid is used up in the plates and becomes more dilute than in the rest of the battery, and the voltage falls correspondingly. The charge and discharge curves of the lead battery may now be taken up in detail.

The Charging Curve. — On closing the charging current, sulphuric acid is immediately set free at both electrodes and the electromotive force therefore rises rapidly, as shown by the portion of the curve *AB*. The rate of diffusion increases with the difference in concentration of the acid on the plates and in the rest of the battery, and when concentration difference has become so great that the rate of diffusion and of formation are equal, this rapid increase ceases. The maximum point at *B* is probably due to the destruction of the thin continuous layer of sulphate which forms on the electrodes during rest, thus reducing the resistance of the cell. The slow regular rise to *C* is due to the gradual increase in the density of the acid and also to the deeper penetration of the current lines into the active mass and the corresponding greater difficulty in equalizing the acid concentration by diffusion. The final rise *CD* takes place when all of the lead sulphate on the surface of the plates has been used up, and consequently the sulphate does not dissolve rapidly enough to replace that electrolyzed out. Very soon the lead and peroxide ions become so dilute that the work necessary to deposit these ions is equal to that required to produce hydrogen on the cathode and oxygen on the anode. If allowed to stand on open circuit, sulphate diffuses from within the plate and brings

back the electromotive force to the normal amount. The maximum point at D is due to the mixing of the concentrated acid in the electrodes with that outside by the gas bubbles.

The Discharge Curve.—In discharge the acid is used up in immediate proximity to the electrodes, and this continues until the concentration difference between the acid on immediate proximity to the electrodes and in the rest of the battery has become so great that diffusion just supplies the quantity used up. During this time the value of V' falls rapidly along AE . The minimum point at E is possibly caused by the formation of a supersaturated lead sulphate solution. The solubility of lead sulphate in a 20 per cent solution of sulphuric acid decreases with decreasing concentration, so that at the beginning of the discharge, when little solid sulphate is present, a supersaturation of short duration is probable, and the electromotive force of the battery decreases with increasing concentration of lead ions, as seen from equation (23). The subsequent gradual fall in the value of V' represented by EF is due to the gradual decrease in the density of the acid in the entire accumulator, but more especially to the greater difficulty in the acid diffusing deeper into the plate as the current penetrates deeper. Finally the rate at which the acid diffuses cannot supply the acid used up by the action of the current, and the value of V' falls off rapidly.

According to this explanation, the loss in energy on charge and discharge is due entirely to the concentration changes that take place in the electrolyte within the active mass. The smaller these concentration changes are, the more nearly will the accumulator approach complete reversibility. This is illustrated in Figure 70. These curves were obtained with accumulator of 200 ampere hours capacity. It is seen that for a current of 0.1 ampere, corresponding to a current density of 0.0017 ampere per square decimeter, the charging and discharging potential differ by only 0.006 volt, or 0.3 per cent of the electromotive force of the cell, and that by reducing the current this loss may be still further reduced.

This loss is not distributed equally between the two plates.

The porosity of the lead plate made from the same sulphate paste as the peroxide is about 1.4 times as great as the peroxide, the potential of the peroxide plate falls off about 1.6 times more than the lead plate for a given change in the concentra-

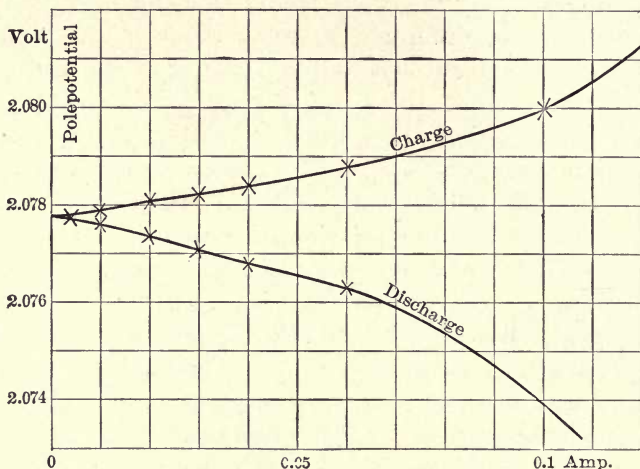

FIG. 70.—Pole potential of the lead storage battery on charge and discharge as a function of the current

tion of the acid, and finally the concentration change on the peroxide plate is greater than on the lead, because not only is sulphuric acid used up on discharge, but water is also formed. All of these facts tend to make the loss on the peroxide plate greater than that on the lead plate. When the positive and negative plates are made of similar frames and paste, and have approximately the same capacity, it has been found that 60 to 70 per cent of the loss takes place on the peroxide plate.

The capacity of an accumulator in actual practice means the number of ampere hours that can be taken from it if discharged to about nine tenths of its original electromotive force, the point where the rapid falling off in the electromotive force takes place. The capacity therefore is determined by the rate of discharge, for the smaller the current the more time the acid has to penetrate by diffusion deeper into the plate, when all of the active material on the surface has been used up. It is also evident

that the conductivity of the acid will affect the capacity, for the higher the conductivity the deeper will the current lines be able to penetrate into the plate. Since there is a density of sulphuric acid at which there is a maximum conductivity, it would be expected that the capacity of a lead storage battery would have a maximum value for this density, and this has been shown experimentally to be the case.

The current efficiency of a lead storage battery, or the ratio of the number of ampere hours obtainable on discharge to the number put into the battery on charge, is from 94 to 96 per cent. The small loss of 4 to 6 per cent is due to self-discharge and to the small amount of gasing that cannot be avoided. The energy efficiency, on the other hand, which is the ratio of the energy obtainable in the external circuit on discharge to the energy put into the battery on charge, is only from 75 to 85 per cent. The cause of this comparatively low value, as explained above, is the difference between the charge and discharge potential. The loss in voltage due to the internal resistance is only about 3 per cent with the usual acid concentration and current density. The loss due to polarization is a minimum when the conductivity of the acid in the battery is a maximum, for in that case the lines of current spread over a larger surface by penetrating deeper into the plate.

If a battery is allowed to stand on open circuit after charging, the electromotive force falls in fifteen or twenty minutes to the value corresponding to the density of the acid. This is due to solution around the plates becoming saturated with lead sulphate. On discharge, when the voltage has fallen below the value corresponding to the density of the acid, standing on open circuit brings it back to the normal value. In this case the recovery, as it is called, is due to the diffusion of the sulphuric acid into the pores of the plate where it has become exhausted.

If a charged cell is allowed to stand idle, the density of the acid slowly decreases, and the amount of electricity obtainable from it becomes less from day to day. This is known as self-discharge, and for a cell in good condition amounts to from one to two per cent a day; if the acid contains impurities, however,

it may amount to 50 per cent a day. The self-discharge of the lead sponge plate is more likely to take place than that of the peroxide plate, as it is affected by a greater number of causes. It is fatal for the lead plate if the acid contains any metal more electronegative than lead in contact with sulphuric acid, such as platinum or gold, for the impurity would be precipitated on the plate and produce a short-circuited local element. The lead would then tend to dissolve and deposit hydrogen on the impurity. If the over-voltage of the impurity is not too great, this would in fact take place, and the lead plate would be changed to sulphate. Now the potential of the cell:

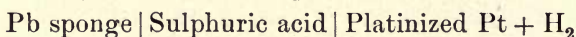

is 0.33 volt, hydrogen being the positive pole. A current could be taken from this cell on closing the external circuit; lead sulphate would be formed on the lead pole and hydrogen would be deposited on the positive pole. But if some metal were substituted for platinum for which the over-voltage is 0.33 volt or more, evidently hydrogen could not be liberated, and no action would take place. Consequently only the metals standing on the left in the following table would be dangerous for the accumulator; those on the right could exist as impurities in the acid without the least danger, even though some of them are more electro-negative than lead.

	OVER-VOLTAGE		OVER-VOLTAGE
Platinized Platinum	0.005	Palladium	0.46
Gold	0.02	Cadmium	0.48
Iron	0.08	Tin	0.53
Platinum, polished	0.09	Lead	0.64
Silver	0.15	Zinc	0.70
Nickel	0.21	Mercury	0.78
Copper	0.23		

As seen from this table, platinum is the most injurious impurity. It has been found that one part of platinum in a million of acid will produce a rapid self-discharge of the lead plate.

It has been found, however, that metals when present together can produce a rapid self-discharge, which alone cause scarcely any action. An explanation of this cannot be given at present.

Contamination by platinum can easily occur when sulphuric acid is used that has been concentrated in platinum retorts, and plates once contaminated cannot be made available again. All other metallic contaminations, if present only in traces, become inactive on continued use of the cell, probably by gradually alloying with the lead.

The self-discharge of the positive plate takes place more slowly than that of the lead sponge plate. Metallic impurities are of no effect on the lead peroxide, for they would not be precipitated on it. The only kind of spontaneous discharge is due to local action between the peroxide and the lead of the support, which together form a short-circuited element, and this is of importance only for plates with a thin layer of peroxide.

Another cause of self-discharge of a battery is the presence of salts of metals that can exist in more than one stage of oxidation. For example, an iron salt would be oxidized to the ferric state on the lead peroxide, and would then diffuse to the lead plate and oxidize it to sulphate, thus gradually discharging both plates.

Sulphating.—The plates of a strongly discharge battery on standing gradually become covered with a white coat of lead sulphate. If we attempt to recharge the battery, it is found that the internal resistance has considerably increased, and it does not begin to diminish until the charging current has passed through the cell for some time; it then gradually approaches its normal value. A test of the capacity would show that this has lost considerably in value. The phenomenon just described is known as *sulphating*. This is not a very suitable term, since in every discharge sulphate is formed on the plates, which is changed back into peroxide and lead without any difficulty. Elbs explains sulphating as follows: During discharge there is formed on every particle of lead or peroxide a thin layer of finely divided sulphate in contact with an acid solution

saturated with the sulphate. If the accumulator is allowed to stand in this condition, and is subject to any variation in temperature, the large crystals will grow at the expense of the smaller ones, for the sulphate increases in solubility as the temperature rises, and the smaller crystals would be used up first, both on account of their size and because the solubility of small crystals is greater than that of large ones. When the temperature falls, the sulphate would be precipitated on the crystals still remaining, and in this way the plate gradually becomes covered with a continuous layer of lead sulphate crystals. Sulphating may be so bad that it is cheaper to replace the plates than to regenerate them by charging.

CHAPTER X

THE EDISON STORAGE BATTERY

1. GENERAL DISCUSSION

THE Edison storage battery is the only accumulator besides the lead battery that has any commercial importance. In this battery the active material of the positive pole is an oxide or oxides of nickel, and that of the negative pole, very finely divided iron. The solution is 21 per cent potassium hydrate with a small amount of lithium hydrate.¹

Edison began to investigate alkaline accumulators in 1898, and after trying a great number of different combinations had the nickel-iron combination fairly well developed in 1900.² It then passed through several more stages of development, and arrived in 1904 at what was called the type E 18 battery. This had twelve nickel plates and six iron plates. The active material of each plate was held in 24 perforated nickel-plated steel pockets 7.5 centimeters in length, 1.27 centimeters in width, and 3 millimeters in thickness. The iron plate was mixed with mercury, the effect of which will be explained below, and the nickel oxide with graphite, to increase its conductivity. This battery had two defects: (1) the nickel plate continually expanded on charging and did not contract on discharge, so that the contacts between the active material and the supports became bad, and (2) the graphite mixed with the nickel oxide gradually disintegrated and did not fulfill its function of conducting the current into the interior of the nickel plate, causing the battery to lose its capacity.¹

¹ Walter E. Holland, *El. World*, **55**, 1080, (1910).

² Kennelly and Whiting, *Trans. Am. Electroch. Soc.* **6**, 135, (1904).

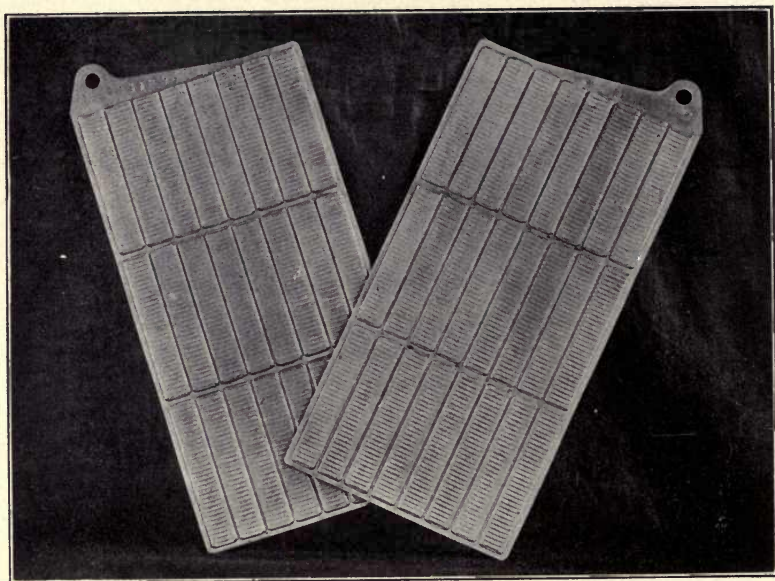

FIG. 71. — Iron electrodes of the Edison storage battery

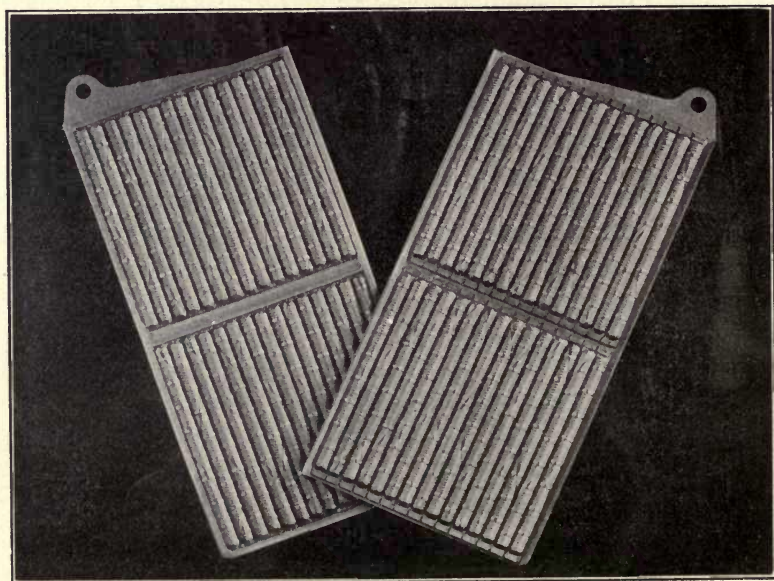

FIG. 72. — Nickel electrodes of the Edison storage battery

Both of these difficulties seem to have been overcome in the latest form of this battery, the A type, which has been on the market since 1908. The construction of the iron electrode, shown in Figure 71, has not been altered, and its dimensions are the same as in the E type, but the nickel electrode has been con-

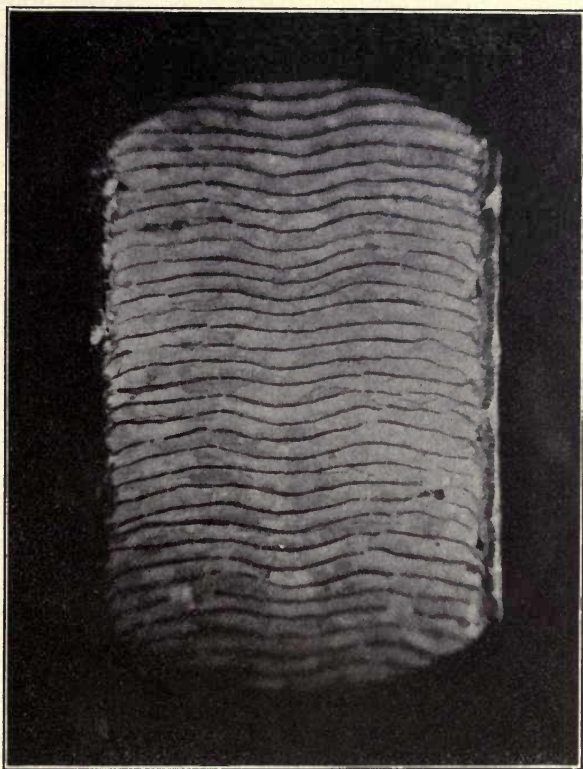

FIG. 73. — Section of pencil from the nickel plate of the Edison storage battery

siderably changed. The nickel plate, shown in Figure 72, was formerly made just like the iron plate, but in the A type it consists of two rows of 16 round pencils, held in position by a steel frame. They have flat flanges at the ends by which they are supported and by which electrical connection is made. These pencils are perforated nickel-plated steel tubes filled with the active material, 0.65 centimeter in diameter and 10.5 centi-

meters in length. They are put together with a spiral seam to resist expansion, and each cylinder also has eight steel rings slipped over it as a further precaution. The graphite is replaced by nickel made into thin flakes, and distributed in regular layers through the active material, as shown in Figure

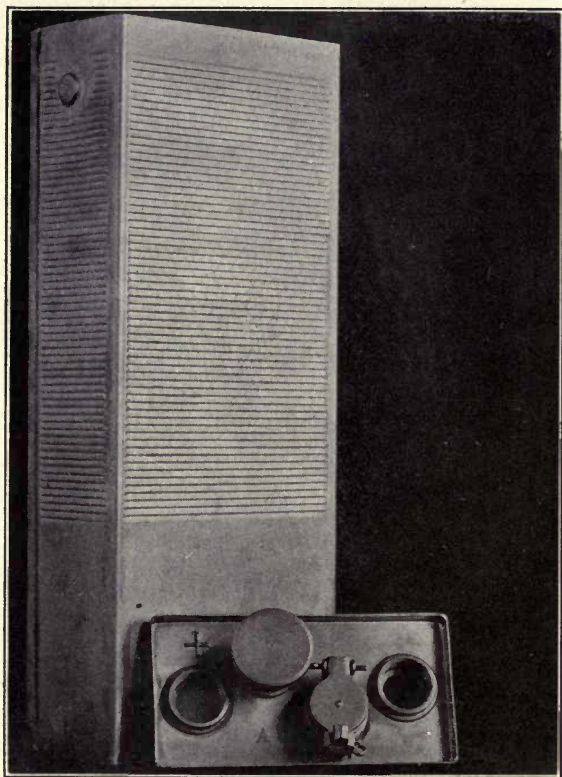

FIG. 74. — Containing can of the Edison storage battery

73, a section of a pencil taken through its axis. The dark layers are nickel flake, and the light-colored layers are the active material. A pencil contains about 350 layers of each kind of material, each layer of active material being about 0.01 inch thick.

As in the earlier battery, the containing can is of nickel-

plated steel, as shown in Figure 74. The top of the can is permanently put in place after the plates are in position. There are four openings in the top, two of which are for the terminals bolted to the groups of positive and negative plates, while the third is for filling, and the fourth contains a valve which allows the gas to escape, but which does not allow any to enter from the outside. The valve is covered with a fine wire gauze to hold back any particles of water coming off with the gas during charging.

The batteries are now made in five sizes. Table 19 gives the principal facts regarding these cells:³

TABLE 19

TYPE	NO. OF POSITIVE PLATES	NORMAL DISCHARGE RATE. AMP.	NORMAL OUTPUT. AMP. HRS.	WT. OF ONE CELL. KGS.	PRICE PER CELL. DOLLARS
A 4	4	30	150	6.1	13.50
A 6	6	45	225	8.7	20.00
A 8	8	60	300	11.4	26.00
B 2	2	—	—	—	6.00
B 4	4	—	—	—	8.00

The average discharge voltage for any type is 1.2 volts, when discharged to 1 volt. As will be explained below, the capacity can be considerably increased by overcharging. According to the catalogue of the Edison Storage Battery Company, the normal capacity of these cells can be increased 30 per cent when charged at the normal rate for ten hours. The continuous rate of discharge may be 25 per cent above the normal rate without injury, and for occasional short intervals it may be four times the normal rate. A cell may stand unused for any length of time without injury, but it is said to be better to leave it discharged in this case. As stated above, this must never be done in the case of a lead storage cell.

³ Catalogue of the Edison Storage Battery Company, and a private communication from Mr. Holland, of this company.

2. THEORY OF THE EDISON STORAGE BATTERY ¹

The active material of the nickel plate when first manufactured consists of green precipitated nickelous hydroxide compressed in a steel pocket under hydraulic pressure. Since it has been found that when nickelous hydroxide is oxidized chemically, it always first changes to nickel peroxide, NiO_2 , it is assumed that the same is true of electrolytic oxidation. This assumption is justified, for it offers an explanation of the behavior of the nickel plate that is in agreement with all of the facts. When the nickelous hydroxide is electrolyzed as anode in a potassium hydroxide solution, it therefore first changes to nickel peroxide. In fact, analysis shows that a freshly charged plate contains as much more oxygen than corresponds to the formula Ni_2O_3 as would correspond to at least 8 per cent of nickel peroxide. The nickel peroxide then reacts on the nickelous oxide as follows:

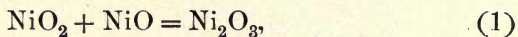

or if no nickelous oxide is in immediate contact with it, it decomposes of itself:

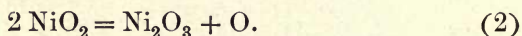

Analysis showed that the charged nickel plate, when dried over sulphuric acid, has the composition represented by the formula $\text{Ni}_2\text{O}_3 \cdot 1.3 \text{H}_2\text{O}$ to $\text{Ni}_2\text{O}_3 \cdot 1.1 \text{H}_2\text{O}$. Any nickel peroxide originally in the plate therefore disappears on drying. It is of course impossible to tell from this whether the nickel oxide is combined with more water before drying or not. In the hydrates given above, the ratio of atoms of nickel to moles of water is 1 : 0.55 to 1 : 0.65, while after the discharge the ratio is 1 : 1. The nickel plate therefore takes up water on discharging, assuming that the oxides have the same amount of water in combination while in the potassium hydrate as after drying. The nickelous compound formed when the nickel plate discharges would then be $\text{Ni}(\text{OH})_2$.

The potential difference between a freshly charged nickel

¹ F. Foerster, Z. f. Elektroch. 13, 414, (1907). The discussion of the nickel plate is taken from this article, except where the contrary is stated.

plate and a 2.8 normal solution of potassium hydrate is -0.88 volt, referred to the dropping electrode as zero. The negative sign refers to the charge on the solution surrounding the electrode. In 50 minutes this potential difference falls to -0.86 volt and in 61 days to -0.75 volt. Analysis of this plate showed the nickel oxide to correspond to the formula Ni_2O_3 . It was also found that the potential difference of an electrode covered electrolytically with nickelic oxide was -0.77 volt. This constant potential reached by the charged plate on standing therefore corresponds to nickelic oxide, and the potential of a freshly charged plate must be due to the nickel peroxide. The peroxide is not stable, but gradually decomposes with the evolution of oxygen, changing to nickelic oxide, and this explains the constant potential arrived at. There is no sudden change when all the nickel peroxide is used up, consequently

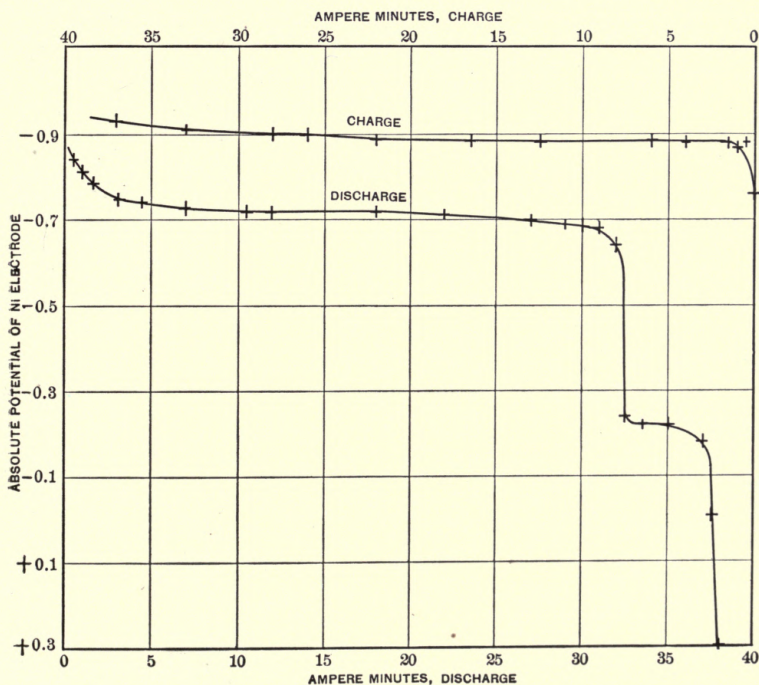

FIG. 75. — Potential of nickel electrode on charge and on discharge

the nickel peroxide and nickelic oxide must form one phase, such as a solid solution. This evolution of oxygen is the cause of the loss in capacity on standing, amounting to 10 per cent in 24 hours, for in this battery the capacity is determined by that of the positive plates.

The change in the potential of the nickel electrode on discharging is shown by the curve in Figure 75. It is of course similar to the discharge curve of the whole battery, since the capacity is determined by this plate. The first part of the curve, concave upwards, is due to the discharge of the solid solution of nickel peroxide in nickelic oxide, as is shown by the fact that this part of the curve entirely disappears if the battery stands idle for twelve hours after charging. The drop towards the end of the discharge of 0.55 volt was shown by analysis to be due to an oxide of nickel lying between Ni_2O_3 and NiO , possibly Ni_3O_4 , as this oxide is known to exist. This second constant potential becomes shorter as the current density increases, and finally disappears altogether.

The charging potential of the nickel plate is more above the potential corresponding to nickelic oxide than the discharge curve is below. This is because the first action in charging is to produce nickel peroxide, which requires a potential at least equal to that of a solid solution of nickel peroxide. The nickel peroxide at first finds a large amount of nickelous oxide which it oxidizes to nickelic oxide. The nickel peroxide therefore disappears rapidly at first, and with a low current density the potential of the plate is not much above that of nickelic oxide. Gradually, however, the peroxide becomes more concentrated and the potential rises. The nickel peroxide then begins to decompose with the evolution of oxygen, until its rate of decomposition equals its rate of formation. Nickel peroxide is formed also by the electrolytic oxidation of nickelic oxide, so that its formation continues even after all of the nickelous oxide has been oxidized.

The efficiency of charging the nickel plate is determined by the amount of oxygen evolved. The curves in Figure 76 show this efficiency for three different current densities, when the

discharge was stopped before the second step was reached. It is evident from these curves that the full capacity cannot be obtained without a loss in the current efficiency. This is quite different from the lead storage battery, in which the efficiency of charging is nearly 100 per cent throughout the whole charge, and then suddenly falls to zero at the end. In speaking of the current efficiency in an Edison storage battery, the capacity must therefore also be given.

The Negative Plate.—The negative or iron plate when charged consists of finely divided metallic iron in the active state. If iron is reduced at a high temperature by hydrogen

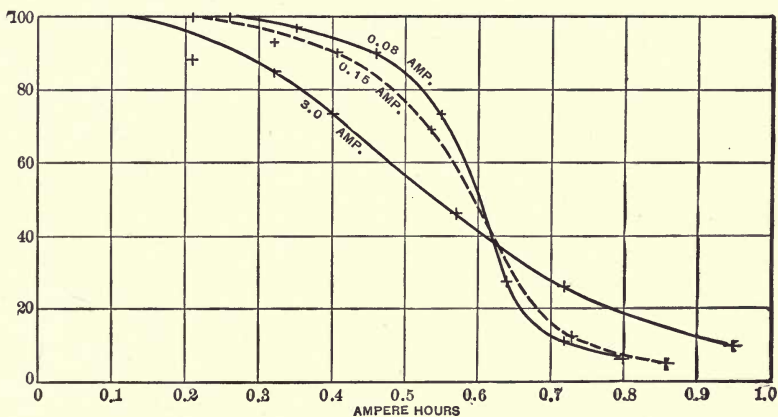

FIG. 76. — Efficiency of charging the nickel plate

and then placed in potassium hydrate, it remains inactive, but after electrolyzing for a short while as cathode in a potassium hydrate solution it becomes active and has considerable capacity.²

The iron electrode also has two stages in its discharge,³ as seen in Figure 77. The first consists in the oxidation of iron to ferrous oxide.² The second step is due to the oxidation of ferrous to ferric iron, due to the iron becoming passive and the velocity of the oxidation of metallic iron becoming too

² F. Foerster and V. Herold, *Z. f. Elektroch.* **16**, 461, (1910). The discussion of the iron electrode is taken from this article, where the contrary is not stated.

³ M. W. Schoop, *Electrochem. Ind.* **2**, 274, (1904).

slow. The oxidation of iron to ferrous hydrate is then replaced partly or entirely by the oxidation of ferrous to ferric iron. If the ferrous hydrate is not supplied rapidly enough by electrochemical oxidation, the metallic iron is oxidized to the ferrous state by the ferric iron. The result of the second step is, there-

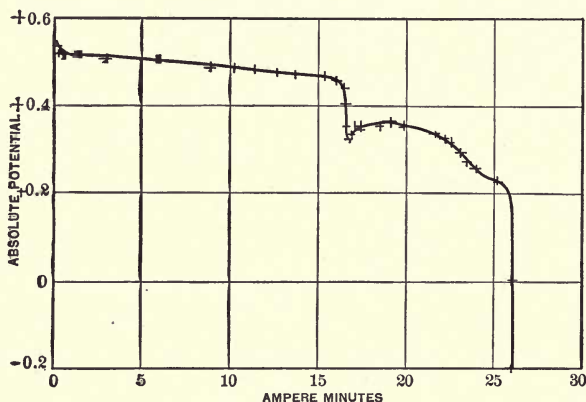

FIG. 77. — Potential of iron electrode on discharge

fore, to change metallic iron to the ferric state. In a 2.85 normal solution of potassium hydrate the potential of the first process is +0.60 volt referred to the dropping electrode as zero, the positive sign referring to the charge on the solution surrounding the electrode. The potential difference between the ferro-hydroxide electrode and a 2.85 normal potassium hydrate solution is +0.47 volt. This difference in voltage between the two steps for the iron electrode is therefore only 0.13 volt, while in the case of the nickel electrode it is 0.55 volt. This second step is of no practical importance, for the iron plate would not reach it when its capacity is greater than the nickel.

The effect of the addition of mercury to the iron plate is to increase its capacity by keeping the iron in the active state. The beneficial effect of mercury was discovered by Edison empirically, but just how it keeps the iron active is not yet understood. The mercury makes it possible, however, for the plate to have a constant capacity for the first step, independent

of the current density, and is therefore of great practical importance. It has no effect on charging. The reason for making the capacity of the iron plate greater than that of the nickel is that the iron electrode should never be discharged as far as the second step, for ferric iron cannot be completely reduced again, and the plates lose in capacity. It has an equally bad effect to allow the iron plate to stand unused in potassium hydrate exposed to the air or to allow it to stand in the air when moist.

In charging, hydrogen is liberated on the iron plate from the start, so that the iron plate causes a greater loss in current than the nickel, on which no gas is liberated during the first part of the charge. It was shown above that the nickel plate changes from $\text{Ni}_2\text{O}_3 \cdot 1.2 \text{H}_2\text{O}$ to $\text{Ni}(\text{OH})_2$ on discharging, and the iron plate from iron to ferrous hydrate. These changes may be represented by the equations: ⁴

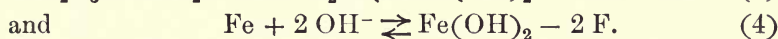
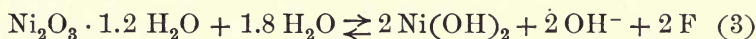

The sum of these equations is

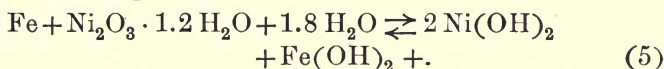

This equation represents the final result in the whole cell on discharge, when taken from left to right, and on charge, when taken from right to left. These equations are not reversible in the ordinary sense, however, for they do not show that hydrogen and oxygen are evolved on charging or that the nickelous hydrate is first oxidized to nickel peroxide. The Edison cell is therefore not strictly reversible, and the equations, though written as reversible, are to be taken only as referring to the initial and final states of the cell. It is also to be noticed that in adding the two equations for the iron and the nickel plates the two quantities of electricity, 2 F, cancel out. This means the two quantities neutralize each other, thereby producing the current.

The Electrolyte. — From the equation (5) it is evident that water is taken up from the electrolyte on discharging by the plates and is given up again on charging. This can be seen by

⁴ Foerster, *Z. f. Elektroch.* 14, 285, (1908).

the change in level in the solution on charging and discharging. According to equation (5), 0.9 mole of water would be combined or set free to one faraday of electricity passing through the cell. Other experiments made for the purpose of determining this quantity gave an average of 1.45 moles of water. This agreement is not all that could be desired. There is no question, however, that water is removed from the solution on discharging, and it therefore follows that the electromotive force of the battery will decrease with the increasing concentration of the electrolyte. This is verified by the measurements of the following table:⁴

NORMALITY OF HYDRATE SOLUTION	E. M. F. OF CELL
1.0	1.3510
1.15	1.3368
2.82	1.3377
5.3	1.3349

From what has preceded, it will be evident that the current efficiency and capacity depend on each other. If the battery is not fully charged, the current efficiency will be high, but the full capacity is not obtained. This can be obtained only by charging after gas evolution has begun, which reduces the current efficiency. When the cell was charged and discharged at the normal rate of 4 hours, the ampere hour efficiency was about 75 per cent, and the voltage efficiency about 70 per cent, making the energy efficiency about 50 per cent.⁵

⁵ Kennelly and Whiting, *Trans. Am. Electrochem. Soc.* **6**, 146, (1904).

CHAPTER XI

THE ELECTRIC FURNACE

1. GENERAL DISCUSSION

THE electric furnace industries are at present in a state of rapid development. This is due partly to the manufacture of a large number of new products made possible by the high temperature attainable in the electric furnace, and partly to improved methods in the manufacture of products previously obtained by other methods.

The electric furnace was probably first used on a commercial scale by the Cowles Brothers in 1884 in their manufacture of aluminum alloys, but the rapid increase in its use began about 1893 with the production of calcium carbide, carborundum, and aluminum.

In the manufacture of many electric furnace products, heat at a high temperature is the form of energy that brings about the change desired. The question naturally arises, how is it possible that it should be economical to obtain heat from such an expensive form of energy as electricity. There are several reasons why it is economical. In the first place, the temperature required for the formation of many electric furnace products is above that attainable by any commercial fuel. In such cases it is evident that if the product is to be formed at all, it must be formed in an electric furnace. On the other hand, it has been found economical to use heat generated from electricity in cases where fuel was formerly used. This is due to a simplification in the apparatus and a saving of time and labor. While electric heat costs more per unit, it may be possible to reduce the time during which it has to be applied to such an extent

that the quantity of heat required is so much less than when fuel is used that it more than saves the extra cost per unit. This is often the case on account of the fact that electric heat is generated inside the furnace or container just where it is wanted, while in the use of fuel the heat is generated outside the furnace and has to penetrate the walls before reaching the material to be heated. It is evident that more heat will be lost in the latter than in the former process.

In those furnaces in which the electricity flows through a core especially made for the purpose and not through the charge itself, the temperature to which the core is raised is one of the factors that determines the time required to bring the charge up to the desired temperature, since the flow of heat between two bodies is proportional to their difference in temperature.

Furnaces may be divided into three classes: arc furnaces, resistance furnaces, and induction furnaces. In the first, as the name indicates, the source of heat is an arc. A solid body to be heated is placed near the arc and is heated by radiation. By adjusting this distance the temperature to which it is raised may be regulated. In case a gas is to be heated, the passage of the arc through the gas itself brings about the desired result. In the resistance furnaces the current generates heat by passing some suitable *resistor*. It is evident that arc furnaces are simply resistance furnaces where the resistor is a gas; but nevertheless this distinction is a convenient one. Resistance furnaces may be of two kinds, first, those in which the current passes through the charge to be treated and develops heat in consequence of the resistance of the charge, and second, those in which the current passes a resistor surrounded by the charge. The latter furnace is used in those cases where the charge itself does not conduct well. The first class of resistance furnace may be divided into two classes, in which (1) the thermal effect is alone active, and (2) in which electrolysis also takes place.

The induction furnace is the latest type, and is used in the steel industry. The metal to be heated forms the secondary winding of a transformer, and forms a closed ring in an annular

crucible. A current is induced from the primary winding sufficiently great to melt the metal.

The following table summarizes this classification.

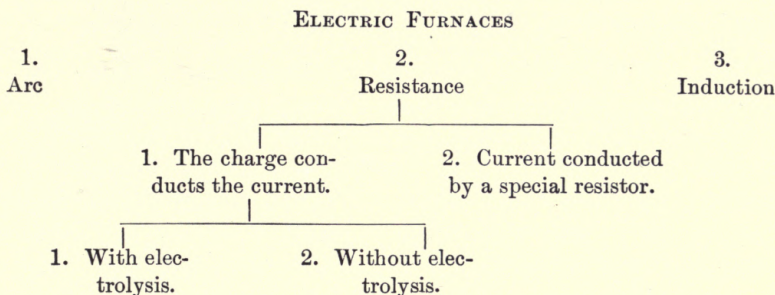

2. ELECTRIC FURNACE DESIGN

In spite of the fact that the heat is generated inside the furnace, there is always some heat lost by conduction through the walls of the furnace, through the electrodes, and in some cases by hot gases. To increase the economy of furnaces these losses must be made as small as possible. The case when the loss is due to gases requires no special consideration, but it will be desirable to consider the losses through the walls and the electrodes.

If H equals the number of calories conducted in one second through a wall of cross section S , thickness l , and specific conductivity k , when the difference in temperature of the two faces is T and no heat is lost through the ends of the walls,

then

$$H = \frac{SkT}{l}.$$

In the case of a furnace, the cross section of the wall is not constant, but increases from the inner to the outer surface. Generally in making this calculation the average cross section is taken. Where the walls are thin, this is fairly accurate, but with thick walls a very great error may be introduced.¹

¹ Carl Hering, Trans. Am. Electrochem. Soc. 14, 215, (1908). The discussion in the text is taken from this article.

For a complete sphere, inner surface s , outer surface S , and thickness of wall l , the heat conducted per second for unit difference of temperature is ²

$$H = \frac{k\sqrt{Ss}}{l} = \frac{\pi k D d}{l},$$

where D is the outside and d the inside diameter. For a cube

$$H = \frac{k\sqrt{Ss}}{l} = \frac{6 k D d}{l},$$

where D is the length of the outer edge and d that of the inner edge. For a cylindrical shell of length C , thickness of wall l , outside diameter D , and inside diameter d ,

$$H = \frac{2 \pi C}{2.3 \log_{10} \frac{D}{d}}.$$

² The derivations of this and the following formulæ, not given by Hering in the article referred to, are very simple. The resistance of a spherical shell of thickness dx , where the radius of the shell is x , is

$$dR = \frac{r dx}{4 \pi x^2}, \text{ if } r = \text{specific resistance.}$$

Integrating between the limits $x = a_1$ and $x = a_2$, where a_1 and a_2 are the inner and outer radii respectively,

$$R = \frac{r}{4 \pi} \left(\frac{a_2 - a_1}{a_1 a_2} \right).$$

But if S is the outer surface and s the inner, $S = 4 \pi a_2^2$, $s = 4 \pi a_1^2$, and $a_2 - a_1 =$ the thickness of the shell. Substituting these values,

$$R = \frac{r l}{\sqrt{S s}}.$$

To get the formula for the cylinder of length C all that is necessary is to integrate the equation

$$dR = \frac{r dx}{2 \pi x} \text{ between } x = a_2 \text{ and } x = a_1,$$

$$\text{giving } R = \frac{r}{2 \pi C} \log_e \frac{a_2}{a_1}.$$

For the cubical frustum

$$dR = \frac{r dx}{n x^2}, \text{ whence } R = \frac{r}{n} \left(\frac{a_2 - a_1}{a_1 a_2} \right) = \frac{r l}{\sqrt{s S}} = \frac{r l}{d D},$$

where n is given by the equation $S = n a_2^2$.

The curves in Figure 78 give an idea of the error that would result from using the mean value of the cross section in place of the above formulæ. As abscissæ are taken the thickness of wall in terms of the inner diameter or edge, and as ordinates the conductivity for one degree difference in temperature and for a substance whose specific conductivity is one. The dotted

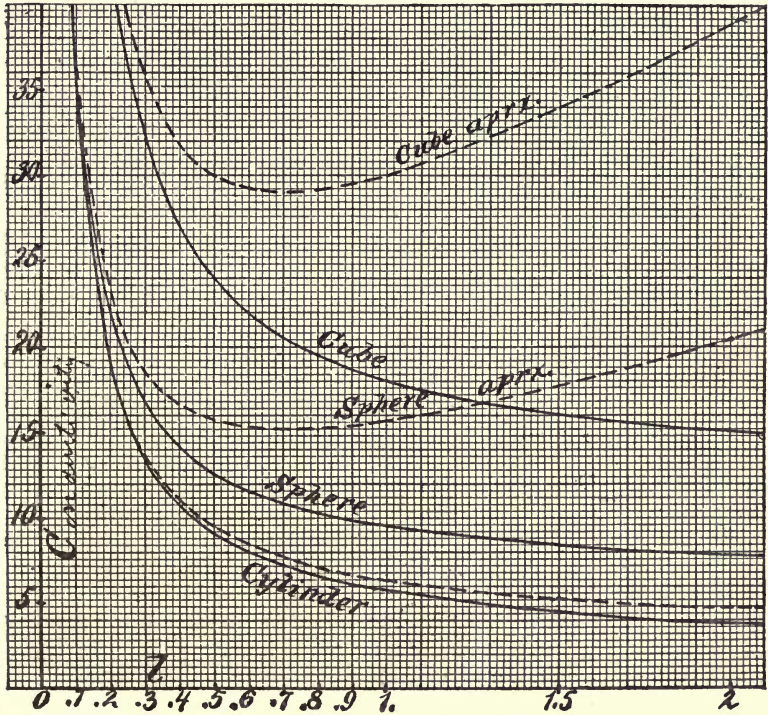

FIG. 78. — Heat loss as function of thickness of walls

lines show the conductivity as given by the approximate formula, and the full lines show the true value. It is evident that the greatest errors occur in the cases of the cube and sphere, where they are quite appreciable when the thickness of the wall equals one half the diameter or one half the inner edge. In Table 20 the values of the heat conducted through the walls of the three typical furnaces are collected, which are those given

in the plot.³ The conductivity and difference in temperature are assumed unity.

TABLE 20
Heat Conductivity of Spherical, Cubical, and Cylindrical Furnaces

THICKNESS	SPHERES		CUBES		CYLINDERS	
	CONDUCTANCE		CONDUCTANCE		CONDUCTANCE	
	By Correct Formula	By Approximate Formula	By Correct Formula	By Approximate Formula	By Correct Formula	By Approximate Formula
0.10	37.70	38.3	72.0	73.2	34.40	34.60
0.15	27.20	28.2	52.0	53.8	23.90	24.10
0.20	22.00	23.2	42.0	44.4	18.70	18.80
0.25	18.90	20.4	36.0	39.0	15.50	15.70
0.30	16.80	18.6	32.0	35.6	13.40	13.60
0.35	15.30	17.5	29.1	33.3	11.80	12.10
0.40	14.10	16.7	27.0	31.8	10.70	11.00
0.45	13.30	16.1	25.3	30.7	9.79	10.10
0.50	12.60	15.7	24.0	30.0	9.06	9.43
0.60	11.50	15.3	22.0	29.2	7.97	8.38
0.70	10.80	15.2	20.6	29.0	7.18	7.63
0.80	10.20	15.2	19.5	29.1	6.58	7.07
0.90	9.77	15.4	18.7	29.5	6.10	6.63
1.00	9.42	15.7	18.0	30.0	5.72	6.28
1.50	8.38	17.8	16.0	34.0	4.53	5.24
2.00	7.85	20.4	15.0	39.0	3.90	4.71
3.00	7.33	26.2	14.0	50.0	3.23	4.19

The following example will show how this table may be used in the case of a furnace of one of these types. Let the inner diameter of a spherical furnace be 15 inches, the thickness of wall 9 inches; to find the heat conductance if the wall consists of infusorial earth whose specific heat conductivity is $k = 0.001$ in gram calorie cubic inch units, and if the difference in temperature between the inside and outside face is 700°C . The

³ Hering, *l. c.* In the original table four and five places of significant figures are given. Since the specific conductivity of refractory substances at high temperatures is not known to more than two places, only three places are here retained.

thickness in terms of the diameter is $\frac{l}{d} = \frac{9}{15} = 0.6$. Opposite

0.6 in the table the conductance is 11.5. This number evidently must be multiplied by d , k , and 700, giving a loss of 121 grams calorie per second. On the other hand, if the loss is given and the temperature difference and conductivity are known, the corresponding thickness can be found.

In the case of the cylinder, the conductivity calculated is for the cylindrical part alone. These values must therefore be multiplied by the length of the cylinder, but not by the inside diameter, and the loss at the two ends must be added.

Unfortunately heat conductivities of refractory substances are not accurately known above 1000°C . Recently, however, the mean conductivities between room temperature and 1000°C . of a number of refractory substances have been determined under the direction of Le Chatelier by Wologdine. The results⁴ have been collected by Queneau in Table 21. Data are also

TABLE 21
Conductivity of Refractory Materials

MATERIAL	CONDUCTIVITY	
	Gram Calorie per Cm. Cube per 1°C . Diff. in Temp.	Relative Conductivity in Per Cent of Value for Graphite
Graphite brick	0.0250	100.0
Carborundum brick	0.0231	92.0
Magnesia brick	0.0071	28.0
Chromite brick	0.0057	23.0
Fire brick	0.0042	17.0
Checker brick	0.0039	16.0
Gas retort brick	0.0038	15.0
Building brick	0.0035	14.0
Bauxite brick	0.0033	13.0
Glasspot brick	0.0027	12.0
Terra cotta	0.0023	9.3
Silica brick	0.0020	7.8
Infusorial earth brick	0.0018	7.1

⁴ Electrochem. and Met. Ind. 7, 383, (1909).

given in the same article on the porosity and gas permeability of these materials.

The principal refractory substances for electric furnaces are carbon, carborundum, and siloxicon.⁵ The use of siloxicon is limited to temperatures below that at which it is converted into carborundum, and of carborundum to temperatures below which it breaks up into silicon and graphite. These substances all have a higher thermal conductivity than the other less refractory materials, as seen in the above table, and for this reason it is usual to build furnace walls in sections, with highly refractory material inside, where the temperature is highest, and with material offering a high resistance to the passage of heat outside. Carborundum, for instance, is one of the most refractory materials, but as seen from the table its conductivity is high. It would, therefore, be well to use this as a lining of such a thickness that the temperature on the outside of the lining would not be too high for some material with a lower heat conductivity, such as fire brick or infusorial earth. Knowing the dimensions, the total loss in power, and the conductivity, the temperature of the cool side of the lining is easily calculated.⁶

The loss of heat due to conductance through the electrodes will next be considered. This loss is made up of two quantities, the heat generated in the electrode by the passage of the current and the heat which would flow from the hot to the cold end if the temperature at the hot end were maintained without passing a current through the electrode. The following demonstration⁷ will show how the total heat loss due to the electrodes is related to these two losses, and how electrodes should be proportioned to make this loss a minimum.

In Figure 79, let ab be a conductor of heat and electricity imbedded, except at its ends, in a perfect insulator of heat and electricity. Let the temperature at a be T° C. and at b , 0° C.

⁵ FitzGerald, *Electrochem. and Met. Ind.* **2**, 349, (1904).

⁶ For examples see Hering, *Electrochem. and Met. Ind.* **7**, 11, (1909).

⁷ Hering, *Trans. Am. Electrochem. Soc.* **16**, 287, (1909); also *Electrochem. and Met. Ind.* **7**, 442, (1909).

Let a current also pass through the electrode. The problem is to find the quantity of heat flowing out the cold end, when a steady state has been reached.

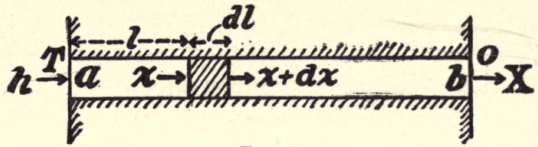

FIG. 79

Let X = total energy in watts pressing out of the cold end.

x = energy passing any cross section at distance l from the hot end.

H = number of watts that would flow from the hot to the cold end were there no current.

h = number of watts entering the hot end.

W = number of watts generated by the current in the electrode.

$w = \frac{W}{L}$ where L = total length of electrode.

T = total fall in temperature from hot to cold end, when cold end is at 0° .

t = temperature at any length l from hot end.

L = total length in centimeters.

l = any distance from hot end.

S = cross section in square centimeters.

k = mean heat conductivity for the given range of temperature in gram-calorie centimeter centigrade degree units.

r = mean electrical resistivity for the given range in ohms for a cube of one centimeter edge.

I = current in amperes.

R = total resistance.

j is the factor 4.19 by which a given number of calories per second is multiplied to change to watts.

Let dl be an infinitely short section at distance l from the hot end, and let the heat flowing into this section be x . The heat generated in the section by the current will be

$$w dl = dx. \tag{1}$$

Also
$$x = -jkS \frac{dt}{dl}, \quad (2)$$

where $\frac{dt}{dl}$ is the heat gradient at l .

Differentiating this gives

$$dx = -jkS \frac{d^2t}{dl^2} dl, \quad (3)$$

and eliminating dx between equations (3) and (1)

$$\frac{d^2t}{dl^2} = -\frac{w}{jkS} = -\frac{I^2r}{jkS^2}. \quad (4)$$

Since r and k are functions of t , to be strictly accurate these quantities should be expressed as such before integrating. For the sake of simplicity, however, mean values for r and k for the temperature interval considered are taken, and these quantities in equation (4) are treated as constants. Integrating once under this assumption gives

$$\frac{dt}{dl} = a - \frac{wl}{jkS}, \quad (5)$$

and a second time

$$t = b + al - \frac{wl^2}{2jkS}. \quad (6)$$

In this equation a and b are determined by the fact that when $l=0$, $t = T$, and when $l=L$, $t = 0$.

Substituting these values in (6) gives

$$b = T, \\ a = \frac{wL}{2jkS} - \frac{T}{L}.$$

Substituting this value of a in (5) and the value of $\frac{dt}{dl}$ thus obtained in (2) gives

$$x = \frac{jkTS}{L} - \frac{wL}{2} + wl. \quad (7)$$

This equation states that the energy passing any given cross section is equal to the energy that would pass were no current flowing, minus one half the I^2R energy, plus the I^2R energy generated in the hot end. When $L=l$, since $wL = W$,

$$X = H + \frac{W}{2}. \quad (8)$$

This states that the energy passing out the cold end as heat equals the energy that would pass out when no current is flowing, plus one half the I^2R energy.

Suppose that in (7) $l = 0$, then $x = h$ and $h = H - \frac{W}{2}$. In order that no heat shall enter the hot end, $h = 0$, whence $H = \frac{W}{2}$. The last equation states that if no heat enters the hot end from the furnace, the heat flowing from the hot to the cold end of the electrode if there were no current equals $\frac{1}{2} I^2R$. Now the product of $H \times \frac{W}{2} = \frac{jI^2rkT}{2}$, which is independent of S and L . When the product of two variables is a constant, their sum is a minimum when the two variables are equal; that is, in the equation $X = H + \frac{W}{2}$, X will be a minimum when $H = \frac{W}{2}$, or the minimum loss = I^2R . Substituting the values of H and W in $H = \frac{W}{2}$, we have the equation

$$4.19 kT \frac{S}{L} = \frac{I^2r}{2} \cdot \frac{L}{S},$$

Solving this for $\frac{S}{L}$

$$\frac{S}{L} = 0.346 I \sqrt{\frac{r}{kT}}, \quad (9)$$

and substituting this value in the equation (8),

$$X = 2.89 I \sqrt{krT}. \quad (10)$$

If, in place of using mean values of the specific heat conductivity and electrical specific resistance, the variable values⁸

$$k_t = k_0(1 + at)$$

and

$$r_t = r_0(1 + a_1t)$$

are substituted in the formulæ above, the following results are obtained :

⁸ H. C. Richards, Trans. Am. Electrochem. Soc. 16, 304, (1909).

$$\frac{S}{L} = 0.346 I \sqrt{\frac{r_0}{k_0 T}} \left(1 + \frac{5 a_1 - 3 a}{12} T \right),$$

and

$$X = 2.89 I \sqrt{k_0 r_0 T} \left(1 + \frac{a + a_1}{4} T \right).$$

The errors introduced by using mean values of k and r and treating them as constants will be small unless the temperature coefficients are enormous.

As was shown above, the minimum loss of one electrode is $I^2 R$ or Ie . Substituting this in (10),

$$e = 2.89 \sqrt{krT}. \quad (11)$$

This voltage is seen to be dependent only on the thermal conductivity, electrical resistivity, and temperature difference of the ends of the electrodes, which means that for every material there is a characteristic minimum drop of potential in the electrodes for one degree difference in temperature below which it is not possible to go without increasing the loss. This minimum drop in

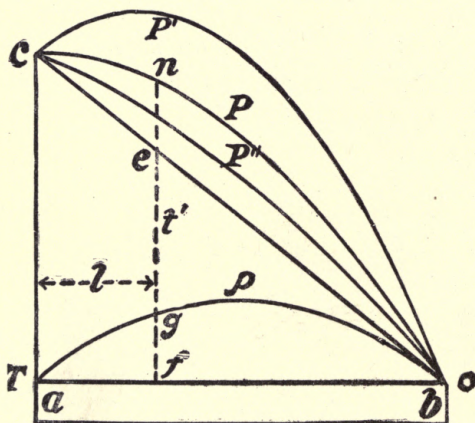

FIG. 80

potential has been called the *electrode voltage*.

The temperature distribution in the electrode is given by the equation:

$$t = T - \frac{Tl}{L} + \frac{Wl}{2jkS} - \frac{wl^2}{2jkS}, \quad (12)$$

obtained from equation (6) by substituting in the values of a and b . The variables being t and l , the curve is evidently a parabola. If no current flows, $w = 0$ and the equation becomes the straight line ceb in Figure 80.

Making $T = 0$ gives $t = \frac{(W - wl)l}{2jkS}$, the parabola p . To find the temperature distribution for minimum loss, solve for T in the equation $jKT\frac{S}{L} = \frac{W}{2}$, and substitute in (12), obtaining

$$t = \frac{w}{2jkS}(L^2 - l^2), \quad (13)$$

the parabola P . When $\frac{W}{2}$ is greater or less than H , the temperature distribution is given by P' or P'' respectively.

In any problem involving the design of electrodes, the temperature difference between the hot and cold ends of the electrode and the kilowatts to be absorbed in the furnace will be given. From the value of the power the voltage would then be made as high and the current as low as practicable. From formula (9) compute the proportion of the section to the length. The length, which should be as short as possible, will be determined by the thickness of the walls of the furnace. Having fixed the length, the section is then obtained from the ratio of the section to the length. The two remaining factors which must be known are the values of the heat and electrical conductivities of carbon and graphite, the only two substances used for electrodes in resistance furnaces. These values have not yet been determined accurately for high temperatures, but the mean values have been determined by Hering between 100° C. and 900° C.⁹ The method of determining heat conductivity depends on the demonstration above.

If in equation (13) $l = 0$, then $t = T$ and $k = \frac{WL}{8jTS} = 0.0299 \frac{WL}{TS}$.

In order to measure k , a conducting rod of length L and section S , embedded in a nonconducting material, is heated by a measured amount of electrical energy and the temperature T measured at the center. In order to have no heat pass out the sides of the rod, it is surrounded by a number of similar rods at the same temperature as the one measured. The electrical conductivity is obtained from the ammeter and voltmeter read-

⁹ Trans. Am. Electrochem. Soc. 16, 317, and 315, (1909).

ings and the dimensions. The values in Table 22 have been obtained by this method.⁹ The units are centimeters, gram calories, and ohms, and centigrade degrees.

TABLE 22

BETWEEN 100° C. AND TEMPERATURE GIVEN BELOW	GRAPHITE		CARBON	
	Heat Conductivity	Electrical Resistivity	Heat Conductivity	Electrical Resistivity
900°	0.291	0.000820	0.129	0.00276
390°	0.339	0.000838	—	—
360°	—	—	0.0890	0.00422

The accuracy of these figures is estimated at a few per cent. The electrode voltage (equation (11)) from these data for one degree for graphite is 0.0447 and for carbon is 0.0639, which means that the minimum loss for carbon is about 50 per cent greater than for graphite. Later measurements by Hering¹⁰ gave results from which the following Table 23 has been computed. The values of heat conductivity and for electrical resistivity are for centimeter cubes.

TABLE 23

TEMPERATURE, C.°		HEAT CONDUCTIVITY	ELECTRICAL RESISTIVITY
Hot End	Cold End		
Carbon			
300	40	0.0891	0.00422
701	50	0.124	0.00381
902	60	0.130	0.00377
Graphite			
355	66	0.339	0.000837
516	70	0.325	0.000827
707	87	0.309	0.000802

¹⁰ Trans. Am. Electrochem. Soc. 17, 166, (1910).

The following data were obtained by Hansen.¹¹ The units are the same as in the table above.

TABLE 24

TEMPERATURE	ACHESON GRAPHITE		NATIONAL CARBON Co.'s ELECTRODES	
	Heat Con- ductivity	Electrical Resistivity	Heat Con- ductivity	Electrical Resistivity
25	—	0.00066 to 0.00260	—	0.00287 to 0.0254
Between 3200 and 200	—	0.00081	—	—
2830 and 30	0.155	—	—	—
3500 and 30	—	—	0.0155	—

The electrical and thermal conductivities of carbon electrodes cannot be determined above 1600°, because on cooling the values do not come back to the original ones, due to a partial conversion of the carbon into graphite.¹¹

Besides the loss in the electrode itself, a large loss occurs at the contact between the electrode and the cable, due to the contact resistance. This resistance varies with the current density, and where brass clamps are used on graphite it amounts to 0.0117, 0.0045, and 0.0039 ohms per square centimeter for current densities of 3.7, 5.6, and 7.4 amperes per square centimeter.¹¹

With the aid of the constants above, a numerical example may be given. Let the capacity of the furnace be 500 kilowatts, the current 10,000 amperes, and the temperature 1700° C. inside and 100° at the cold end of the graphite electrode. Assuming $r = 0.000820$ and $k = 0.291$, by formula (10), $X = 17.8$ kilowatts for each electrode. Assuming for carbon, $r = 0.00276$ and $k = 0.129$, $X = 21.8$ kilowatts. Of course, the cross sections of the graphite and carbon electrodes are not equal for equal lengths.

¹¹ Trans. Am. Electrochem. Soc. 16, 329, (1909).

The discussion so far has been for the case that the dimensions of the furnace and the power to be applied in order to bring about a desired result are known. If these are not known, an experiment would usually be made on a small scale in order to determine the relation between the size of furnace and the power. There are two cases to be considered, (1) when there is a central core for carrying the current, and (2) when the charge to be heated itself carries the current.

In the first case the heat has to be conducted from the core to the surrounding charge.¹² The rate of this flow is proportional to the difference in temperature of the core and the surrounding charge, the thermal conductivity of the charge, and the surface area of the core. If heat is generated in the core at a given rate, the temperature to which it will rise in a given time will depend on the specific heat of the core and the rate at which the heat flows into the surrounding charge. This rate of flow depends on the area of the core and the conductivity of the charge. Suppose that to bring about the desired reaction in a given charge with a core of a given material experiments are made with a small furnace until the conditions are found under which the desired reaction is brought about. This means that a definite amount of heat must pass per unit surface of the core, which is a constant for these materials and is independent of the dimensions. If the voltage is E and the

current I , the energy in watts per unit surface is $a = \frac{EI}{2\pi PL}$,

when P is the radius and L the length of the core. Collecting the constants in one factor, this may be written $PL = AEI$.

If r is the specific resistance of the core, we also have $\frac{E}{I} = \frac{rL}{\pi P^2} = B \frac{L}{P^2}$. For any furnace of any other dimensions

L_1 and P_1 , the voltage and current E_1 and I_1 are given by the

equations $P_1 L_1 = AE_1 I_1$ and $\frac{E_1}{I_1} = B \frac{L_1}{P_1^2}$. From these equa-

tions we could solve for the new values E_1 and I_1 , if L_1 and P_1

¹² FitzGerald, *Electrochem. and Met. Ind.* **2**, 342, (1904).

are given. Usually, however, the power is given, and the proper dimensions L_1 and P_1 are desired. Solving for these

quantities,
$$P_1 = P \left(\frac{I_1}{I} \right)^{\frac{3}{2}},$$

and
$$L_1 = L \frac{E_1}{E} \left(\frac{I_1}{I} \right)^{\frac{1}{2}}.$$

The following is an example of the use of these formulæ. It was desired to design a 200-kilowatt furnace using a current of 4000 amperes and 50 volts. Experiments on a small scale showed that the right conditions were obtained with 200 amperes at 100 volts and a core 365 centimeters long and 5.1 centimeters in radius. From these values the proper length and radius for the large furnace are found to be 495 centimeters and 37.6, respectively.

For the second case, where the current passes through the charge itself, it is simply necessary to know the amount of heat required to raise a given mass to the desired temperature, that is, the number of watts per unit mass. If the specific heat of the charge is known, this can be computed; if not, an experiment on a small scale with a given mass will determine the energy required.

CHAPTER XII

PRODUCTS OF THE RESISTANCE AND ARC FURNACE

1. CALCIUM CARBIDE

THE discovery of calcium carbide is due to Wöhler,¹ who prepared it by the action of carbon on an alloy of calcium and zinc. Even previous to Wöhler, E. Davy had also produced it in an impure state without identifying it.² The commercial importance of calcium carbide, however, dates from its rediscovery by Thomas L. Willson,³ which was nearly simultaneous with that of Moissan (1892).

The reaction between lime and carbon by which calcium carbide is produced is the following :

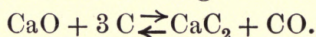

As indicated, this is a reversible reaction, and according to the Phase Rule has one degree of freedom ; that is to say, at a given temperature there is one definite pressure of carbon monoxide which corresponds to equilibrium. At 1475° C. this pressure has been found to be 0.82 millimeter of mercury.⁴ Above 1500° calcium carbide decomposes into its elements, but of course not as rapidly as it is produced, otherwise its manufacture would be impossible.

When calcium carbide is formed from calcium and diamond, 7250 calories are absorbed at room temperature. When formed from lime and carbon, 121,000 calories are absorbed at room temperature, and the temperature coefficient of the heat of the

¹ Ann. d. Chem. und Pharm. **125**, 120, (1863).

² Lieb. Ann. **23**, 144, (1836). See Abegg, Handbuch der anorganischen Chem. **2**, 119.

³ Lewes, Acetylene, p. 24, (1900).

⁴ Thompson, Proc. Am. Acad. **45**, 431, (1910) ; also Met. and Chem. Eng. **8**, 327, (1910).

reaction has been calculated to be 3.3 calories per degree.⁵ The fact that heat is absorbed when the above reaction proceeds from left to right shows that the equilibrium pressure of carbon monoxide increases with the temperature, and it can be calculated that at about 1840° the pressure equals one third of an atmosphere. If carbon were heated in the presence of air much above red heat, all the oxygen would be converted to carbon monoxide, and if none escaped, its resulting partial pressure would be one third of an atmosphere. It would therefore be necessary to heat carbon and lime to a temperature above 1840° C. before carbide could be formed. In actual practice, however, the partial pressure of carbon monoxide would be less than one third of an atmosphere, in which case carbide could be formed at a lower temperature. Taking these facts into consideration, it does not seem probable that 2000° C. is exceeded in actual practice, for high temperature would accelerate the decomposition of the carbide already formed. This explains the fact that a resistance furnace, in which the temperature is lower than in the arc, gives better yields than an arc furnace.⁶

Commercial calcium carbide is dark colored and crystalline but if pure it is colorless and transparent.⁷ It has a density at 18° of 2.22, and is insoluble in all known solvents. It is a powerful reducing agent. If heated with metallic oxides it gives, according to circumstances, an alloy of the metal in question with calcium or the metal itself, probably according to the reaction.⁷

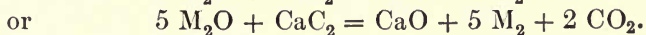

It further has the property of absorbing nitrogen according to the equation

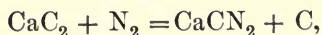

forming calcium cyanamide. This is an important method of fixing atmospheric nitrogen, and will be referred to later under that heading.

⁵ Thompson, *Trans. Am. Electrochem. Soc.* **16**, 202, (1909).

⁶ Tucker, Alexander, and Hudson, *Trans. Am. Electrochem. Soc.* **15**, 411, (1909).

⁷ Abegg, *Handbuch der anorganischen Chem.* **2**, p. 121.

The principal use of calcium carbide is to produce acetylene for illumination. This gas is evolved when the carbide is treated with water, according to the reaction:

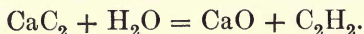

The first to produce calcium carbide on a commercial scale, as stated above, was Thomas L. Willson, at the Willson Aluminum Works at Spray,⁸ North Carolina. Willson was attempting to reduce lime by heating with carbon, hoping to get calcium with which to try the reduction of alumina. It was by accident that the material produced was found to react with water and give off an inflammable gas. Soon after this discovery Willson's plant at Spray was investigated by Houston, Ken-

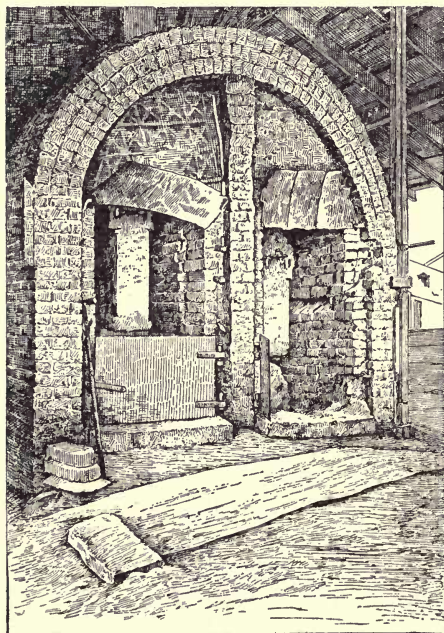

Fig. 81. — Carbide furnace at Spray, North Carolina

nally, and Kennicutt.⁹ Two runs were made with the purpose of determining the cost of manufacturing calcium carbide under conditions existing at that place. There were two furnaces built in one structure, as shown in Figure 81, the walls and partition of which were brick, while the front was only partly covered by cast-iron doors. The floor space of each furnace was 3 by 2½ feet. The furnaces united at a height of 8 feet into a single chimney for carrying off the gases. The base of the furnaces con-

⁸ J. W. Richards, *Electrochem. Ind.* **1**, 22, (1902). The date given by Richards is 1891. This is evidently too early; see note 3.

⁹ *Progressive Age*, **14**, 173, (April 15, 1896). (Published at 280 Broadway, New York City.)

sisted of a heavy piece of iron between, 1 and 2 inches in thickness, 6 feet in length, and $2\frac{1}{2}$ feet in width. The iron plate was completely covered by two carbon plates between 6 and 8 inches thick. These formed the lower electrode. The upper electrode of each furnace was a carbon block 12 by 8 inches in section and 36 inches long, protected by an iron casting $\frac{3}{32}$ inch thick. The space between the casting and carbon was filled with a mixture of hot pulverized coke and pitch. The first run lasted 3 hours with an average activity supplied to the furnace of 144 kilowatts at approximately 100 volts. This made a total power consumption of 432 kilowatt hours, yielding 98.0 kilograms of 79 per cent pure carbide. The second run lasted 2

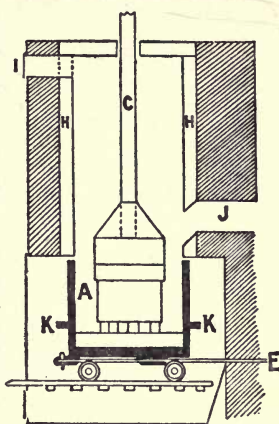

FIG. 82. — Longitudinal vertical section of the first carbide furnaces at Niagara Falls

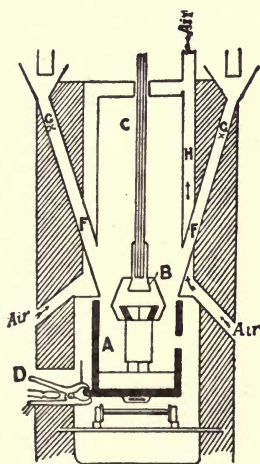

FIG. 83. — Transverse vertical section of the first carbide furnaces at Niagara Falls

hours and 40 minutes with an average activity of 146.7 kilowatts, making the total power consumption 388.5 kilowatt hours and yielding 87.5 kilograms of 84 per cent carbide. This is about 0.225 kilograms of carbide per kilowatt hour. The cost of producing carbide at Spray, working the furnaces 365 days a year and 24 hours a day, was estimated at about \$33 per 2000 pounds of impure carbide. This estimate, however, is made up of a large number of items that would be considerably changed for other places.

The largest producer of carbide in the United States is the Union Carbide Company, whose works are at Niagara Falls. Their first furnaces were of the Willson type, in which the lower electrode was a small car which could be removed, when filled with an ingot of carbide, to make room

for another, as shown in Figures 82 and 83. This type has been displaced at Niagara Falls by the Horry rotary continuous furnace, introduced in

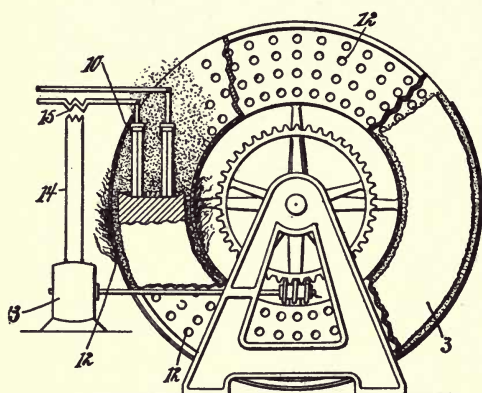

FIG. 84. — Horry carbide furnace

1898 and shown in Figure 84.¹⁰ It consists of an iron wheel 8 feet in diameter and 3 feet in width, with an annular-shaped space around the circumference in which the carbide is formed. The electrodes project vertically down into this space. Lime and carbon are fed in, and as

carbide forms, it is removed from the electrodes by the rotation of the furnace. Iron plates hold the carbide in place while under the influence of the current. When the rotation has carried it to the other side of the furnace, it has had time to cool, as there is only one complete rotation a day. The outer plates are then removed, and the carbide is broken off in pieces 6 to 9 inches thick. Each furnace takes 3500 amperes at 110 volts and produces 2 short tons of carbide a day.

COUNTRY	PRODUCT IN METRIC TONS
United States and Canada	38,000
Italy	32,000
France	27,000
Norway	25,000
Switzerland	20,000
Austro-Hungary	12,000
Sweden	12,000
Germany	9,000

¹⁰ Lewes, *ibid.* p. 207; Richards, *Electrochem. Ind.* 1, 22, (1902); Haber, *Z. f. Elektroch.* 9, 834, (1903).

The production of the Union Carbide Company from year to year has not been made known. The preceding table shows the estimated output of the world for 1908.¹¹

In 1902 the Union Carbide Company sold carbide to home consumers at about \$70 a ton, but exported it for \$50 a ton.¹² In 1907 the price was still \$70 a ton in this country.

In Europe¹³ the form of furnace still used is of the Willson type. In some cases the ingot is formed on a truck that can be removed when full, and in others a stationary crucible is used. In the former case it has been found an improvement to have two electrodes suspended over the truck, so that the truck is no longer in the electric circuit. In the case of fixed crucibles the capacity has been increased in some cases up to 6000 kilowatts, and a more satisfactory method of tapping has been devised. Formerly the solid carbide formed around the tap hole had to be broken away, but the later method consists in inserting an iron rod connected to the upper electrode into the tap hole, where an arc is formed between the rod and the solid carbide. The iron and carbide are both melted by the arc, and an opening is formed through which the melted carbide can flow out.

With regard to the power required for the production of carbide, the only figures of any practical importance are not those obtained by calculation, but those obtained in actual practice. The original plant of Willson produced 5.4 kilos per kilowatt day of 24 hours⁹ of 80 to 85 per cent carbide. At Meran the yield is 5.8 kilos of 78 per cent carbide per kilowatt day.¹⁴ At Foyers in Scotland the yield per kilowatt day of 24 hours is 4.2 kilos of 87 per cent carbide.¹⁵ At Odda, Norway, it lies between 4.5 and 5.2 kilograms.¹⁶

The materials¹⁷ used in making carbide are freshly burnt lime and carbon in the form of anthracite coal, metallurgical coke, or charcoal. Ordinary gas coke has too many impurities for this purpose. Charcoal is used only where one of the other forms of carbon cannot be obtained, as it generally contains

¹¹ Min. Ind. 17, 100, (1908).

¹² Min. Ind. 11, 76, (1902).

¹³ See Conrad, *Electrochem. and Met. Ind.* 6, 397, (1908).

¹⁴ Lewes, *Acetylene*, p. 242.

¹⁵ Lewes, *l.c.* p. 262.

¹⁶ *Electrochem. and Met. Ind.* 7, 213, (1909).

¹⁷ Lewes, pp. 264-284.

considerable traces of phosphates, which appear in the acetylene generated from the carbide in the form of phosphureted hydrogen. The reaction requires 36 parts of carbon to 56 of lime. In most ingot carbide furnaces 100 parts of lime to 70 of carbon are used. In furnaces from which the carbide is drawn off in the liquid state a higher proportion of lime is used in order to lower the melting point of the carbide. This, of course, has the result of making the carbide less pure.

It was at first supposed that fine grinding of the materials was necessary, but it has since been found that pieces as much as one inch in diameter may be used.¹⁸

2. CARBORUNDUM

Carborundum is the trade name for the carbide of silicon, which has the formula CSi . It was probably first produced by Despretz in connection with experiments on refractory materials,¹ in the course of which he heated a carbon rod embedded in sand by passing an electric current through the rod. He obtained a very hard tube of six times the diameter of the carbon rod, lined on the inside with quartz in the form of lampblack. It seems probable that in this experiment some carborundum was formed, though no mention is made of crystals. It seems more certain that carborundum crystals were obtained by R. Sidney Marsden,² by heating for several hours silver or an alloy of silver and platinum in a Berlin porcelain crucible with amorphous carbon considerably above the melting point of silver and then cooling slowly for 12 to 14 hours. On dissolving the silver in nitric acid it yielded from its interior a number of beautiful crystals of the hexagonal system and varying in color from light yellow to dark brown, or even black. Other crystals were found in the form of hexagonal prisms, but these were in most cases colorless and transparent. The colored crystals were doubtless crystallized carborundum, formed from the silica glaze on the crucibles and the amorphous carbon.

¹⁸ Blount, *Practical Electrochemistry*, p. 230, (1901).

¹ C. R. **89**, 720, (1849).

² *Proc. Royal Soc. of Edinburgh*, **11**, 37, (1880-1881).

The white crystals were evidently silica, as they dissolved when boiled in hydrofluoric acid.

In 1886 A. H. Cowles³ obtained some hexagonal crystals from his furnace on attempting to melt quartz. This was analyzed and thought to be a suboxide of silicon. On seeing Acheson's Carborundum at the Chicago Exposition in 1893, Cowles recognized its similarity with his so-called suboxide of silicon. This resulted in a lawsuit between the Cowles Electric Smelting and Refining Company and the Carborundum Company.⁴ Schützenberger and Colson had suspected the existence of a compound of the formula Si_2C_2 as early as 1881,⁵ and in 1892 Schützenberger⁶ obtained the amorphous carbide of silicon by heating together silicon, silica, and carbon, and determined its composition. Its color was a clear green. Finally, Moissan⁷ has made crystallized carbide of silicon in the following different ways: 1. Carbon was dissolved in melted silicon between 1200° C. and 1400° C. from which crystals of carbide several millimeters long were obtained by dissolving the silicon in a boiling mixture of concentrated nitric acid and hydrofluoric acid. 2. By heating silicon and carbon in the proportion of 12 parts of carbon to 28 parts of silicon. The mass of crystals obtained was easily purified by first boiling in a mixture of concentrated nitric acid and hydrofluoric acid and by then treating with nitric acid and potassium chlorate. The crystals were frequently colored yellow, but could be obtained completely transparent. 3. By heating a mixture of iron, silicon, and carbon in the electric furnace, giving a metallic fusion containing crystals of carbide of silicon. The excess of iron or silicon was then dissolved. 4. By heating silica and carbon in the electric furnace. 5. By the action of the vapor of silicon on the vapor of carbon. This experiment was made in a small carbon crucible containing fused silicon. The bottom of the crucible was heated to "the highest tempera-

³ Proc. of the Soc. of Arts for 1885-1886, p. 74, Boston.

⁴ FitzGerald, Carborundum, in the Engelhardt Mongraphien über Ange wandte Elektrochemie.

⁵ C. R. **92**, 1508, (1881).

⁶ C. R. **113**, 1089, (1892).

⁷ Moissan, The Electric Furnace, translated by Lehner, p. 274, (1904).

ture of the electric furnace." After the experiment, slightly colored, very hard and brittle crystals in prismatic needles of carbon silicide were found. The description of this experiment is far from convincing. If the crystals were found in the silicon, there is no evidence of the action of one vapor on the other, but even the original article⁸ does not state *where* the crystals were found, which would be necessary to decide the question.

In 1891 at Monongahela, Pennsylvania, E. G. Acheson⁹ discovered the crystallized carbide of silicon, in carrying out some experiments with the object of producing crystallized carbon. The object was to dissolve carbon in melted silicate of aluminum, or clay, and by cooling to cause the carbon to crystallize. The first experiments were carried out in an iron bowl lined with carbon in which was placed a mixture of carbon and clay. The mixture was fused by means of an electric current passing between the bowl and a carbon rod directly over it. On fusion a violent reaction took place, and after cooling a few bright blue hard crystals were found. These were first supposed to be carbon, but later were taken for a compound of alumina or corundum and carbon, from which the name carborundum was made up. Subsequent to this it was found that better results were obtained when silica was used in place of clay, and when common sodium chloride was added. The reason for this was evident when the following analysis of the product was made:

Silicon	62.70 per cent
Carbon	36.26 per cent
Aluminum oxide and ferric oxide	0.93 per cent
Magnesium oxide	0.11 per cent

This showed the substance in the pure state to be CSi.

The furnace in which these experiments were carried out was made of refractory bricks, the interior dimensions being 10 by 4 by 4 inches. The current was carried by a core of granulated carbon, as shown in Figure 85.

⁸ C. R. 117, 425, (1893).

⁹ Journ. of the Franklin Inst. 136, 194 and 279, (1893).

Figure 86 shows an end view of this furnace and the layers of different materials after a run. *B* is a solid mass of sand

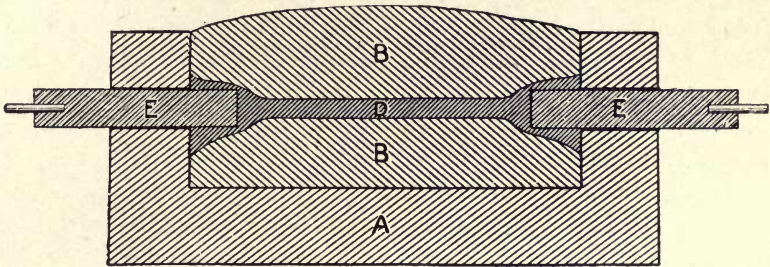

FIG. 85. — Longitudinal section of Acheson's experimental carborundum furnace

and carbon held together by fused salt. *C* is chief product of the reaction, crystallized carbide of silicon. *W* represents a white or gray-greenish-looking shell, and consists of small pieces the size of the original grains. They are soft, and may easily be reduced to fine powder, and are of no value as an abrasive, though analysis shows them to be principally carbide of silicon. It is amorphous carborundum, or *carborundum fire sand*. *G* is graphite mixed with carborundum, and *D* is the core, only a portion of which becomes graphitized even though used repeatedly. The output of this small furnace was $\frac{1}{4}$ pound a day.¹⁰

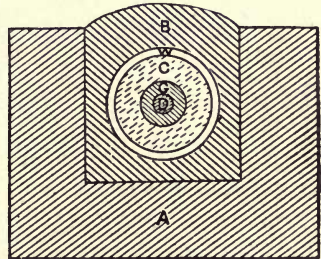

FIG. 86. — Transverse section of Acheson's experimental carborundum furnace

The furnaces used at Monongahela in 1893 were 18 inches wide, 12 inches deep, and 6 feet long. The core was of granular carbon in the form of a sheet 10 inches wide, 1 inch deep, and $5\frac{1}{2}$ feet long. In $7\frac{1}{2}$ to 8 hours a portion of the charge was transformed into 50 pounds of crystallized carborundum.

On moving to Niagara Falls the furnaces were constructed as shown in Figure 87.¹¹ The end walls are built of refractory

¹⁰ FitzGerald, Journ. Franklin Inst. 143, 81, (1897).

¹¹ FitzGerald, Carborundum, p. 8.

brick and clay, and carry electrodes, b^2 , consisting of rectangular carbon rods clamped together. Contact is made with the copper cables by the copper plates, b^5 , as shown. A are the brick side walls of the furnace put together without cement. D is the mixture, C the core of granulated carbon, and c is fine carbon powder for the purpose of making contact between the carbon electrodes and the core. Up to 1907 the total length of this furnace was 7 meters; the inside dimensions were, length, 5 meters, width, 1.8 meters, and height, 1.7 meters. The electrodes consisted of 25 carbon rods, 86 centimeters in length, and 10 by 10 centimeters in cross section. The core was 53

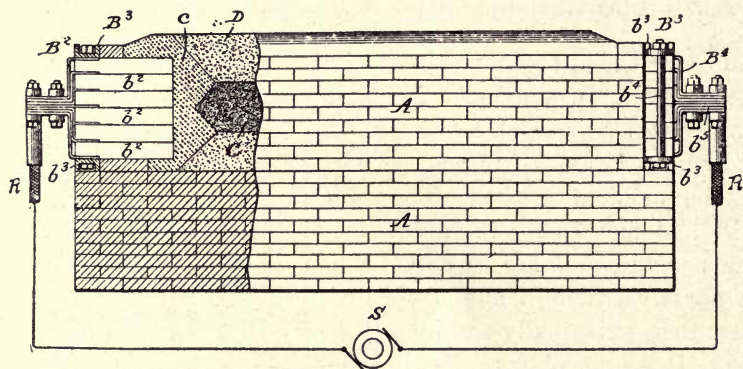
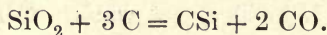

FIG. 87. — Longitudinal section of carborundum furnace

centimeters in diameter. A perspective of the furnace in operation is shown in Figure 88.

The power absorbed by each furnace is 746 kilowatts. The voltage varies from 210 volts at the start to 75 volts when the resistance of the core had dropped to its final constant value. Soon after the current is turned on, carbon monoxide is produced, due to the oxidation of the carbon in the core and in the charge. The gas is always lighted, and burns during the run. When the temperature has become sufficiently high, carborundum is formed according to the following reaction :



The heating lasts 36 hours, and produces 3150 kilograms of crystallized carborundum, surrounding the core to a depth of

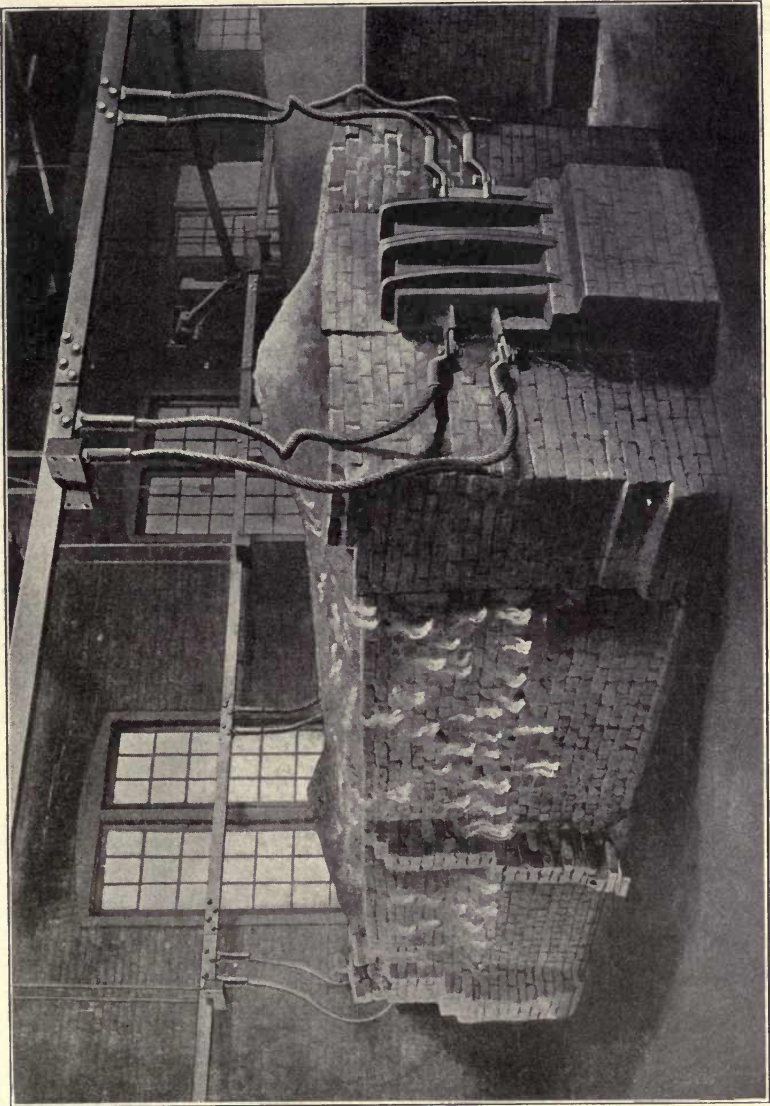

Fig. 88. — Carborundum furnace in operation

from 25 to 30 centimeters, This corresponds to 8.5 kilowatt hours per kilogram, which is a great improvement over the first furnaces of the Carborundum Company at Monongahela, which were built for 100 kilowatts, and yielded one kilogram of carborundum for an expenditure of 17.6 kilowatt hours. The present electrical equipment of the Carborundum Company at Niagara Falls has a capacity of 5300 kilowatts.¹²

The raw materials used by the Carborundum Company consist of ground quartz 99.5 per cent silica, coke, such as is used in blast furnaces, sawdust, and sodium chloride. The object of the sawdust is to make the charge porous to facilitate the escape of the carbon monoxide. The coke used for the core is sifted to get rid of the powder; that used for the charge is powdered. The charge is made up in lots of 500 kilograms, and has the following composition :

Quartz	261 kilograms
Coke	177 kilograms
Sawdust	53 kilograms
Salt	<u>9 kilograms</u>
	500

In 1907 the furnace plant was remodeled,¹³ and the furnaces were made 9.15 meters long and 3.67 meters wide. These are presumably outside dimensions. The power absorbed is now 1600 kilowatts with the maximum current 20,000 amperes. The yield of each furnace in one run is 15,000 pounds, or 6800 kilograms, of crystallized carborundum. On coming from the furnace the carborundum is ground, treated with concentrated sulphuric acid to remove harmful impurities, and is washed with water. It is then sorted into different sizes.

Table 25 gives the production of carborundum in this country and its value including the year 1909.¹⁴

¹² *Electrochem. and Met. Ind.* 7, 190, (1909).

¹³ *Min. Ind.* 16, 155, (1907); 17, 112, (1908).

¹⁴ *Min. Ind.* 18, 86, (1909).

TABLE 25

YEAR	METRIC TONS	VALUE IN DOLLARS
1891	0.023	—
1892	1	—
1893	7	—
1894	24	—
1895	102	—
1896	540	366,000
1897	564	154,000
1898	724	151,000
1899	791	157,000
1900	1089	168,000
1901	1742	268,000
1902	1698	261,000
1903	2160	333,000
1904	3203	494,000
1905	2539	391,000
1906	2824	435,000
1907	3418	452,000
1908	2226	294,000
1909	2983	389,000

In 1902 the cost of manufacture was 4 cents to 5 cents a pound, and during this year the average selling price was 10 cents a pound.¹⁵ The only producer in this country is the Carborundum Company of Niagara Falls. In Europe it is produced at La Bathie, France, Iserhohn, Germany, and Prague.¹⁶

Carborundum is used principally as an abrasive and as a substitute for ferrosilicon in the manufacture of steel. In 1902 one third the total output was consumed in this industry.¹⁷ The abrasive qualities of carborundum are affected by its great brittleness, on account of which it will not cut diamond unless reduced to a fine powder.⁹ It is made into polishing wheels by mixing with a certain amount of kaolin and feldspar as a binder, compressing in a hydraulic press, and burning in a furnace such as is used in the manufacture of porcelain. Carborundum is

¹⁵ Min. Ind. 11, 78, (1902).

¹⁶ Min. Ind. 10, 253, (1901).

¹⁷ Min. Ind. 11, 227, (1902).

also used in wireless telegraphy as a detector, and in a different form, known as *Silundum*,¹⁸ as a resistance for heating purposes. Silundum is made by exposing rods of carbon to the vapor of silicon, which penetrates the carbon, changing it to silundum and thereby increasing its electrical resistance to a sufficient extent to make it a good resistor. In the form of bricks carborundum is used as a refractory material in building furnaces, when the temperature to be withstood is very high.

Silicon carbide is colorless when pure,¹⁰ but the commercial product is black, due either to carbon, iron, or to a thin film of silica¹⁹ on the surface. The following analysis is due to Moissan :

	PER CENT		
	I	II	Theoretical
Silicon	69.70	69.85	70.00
Carbon	30.00	29.80	30.00

The following is an analysis of Acheson's product :¹¹

Silicon	64.93 per cent
Carbon and oxygen	33.26 per cent
Loss in heating	1.36 per cent
Aluminum	0.25 per cent
Calcium, magnesium, iron	trace
	<u>99.80 per cent</u>

When the same material was purified by hydrochloric acid and sodium hydrate, by heating in oxygen, and finally by heating with hydrofluoric acid, its analysis gave the following result :

Silicon	69.10 per cent
Carbon	30.20 per cent
Al ₂ O ₃ and Fe ₂ O ₃	0.49 per cent
CaO	0.15 per cent
	<u>99.94 per cent</u>

The density is 3.2. The crystals have been found by Frazier to be rhombohedral.²⁰ It easily scratches ruby, and, as stated above, when finely powdered, will polish diamond.

¹⁸ Bölling, *Electrochem. and Met. Ind.* **7**, 25, (1909).

¹⁹ *Min. Ind.* **16**, 155, (1907).

²⁰ *Journ. Franklin Inst.* **136**, 289, (1893).

When carborundum is heated to a sufficiently high temperature silicon is vaporized, leaving carbon in the form of graphite. The temperature at which decomposition takes place has been found by Tucker and Lampen²¹ to be 2220° and the temperature of formation, 1950° C. There is hardly a doubt that both the reactions,



and

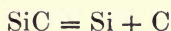

are reversible. The temperature of formation therefore depends on the partial pressure of carbon monoxide, and the temperature of decomposition on the partial pressure of silicon vapor, for according to the Phase Rule each of these systems has one degree of freedom. These values, however, probably represent fairly well the temperatures of formation and decomposition in the Acheson furnace.

Carborundum is not attacked by sulphur or oxygen at 1000° C.,⁷ but according to Acheson it is oxidized in an atmosphere containing considerable oxygen at 1470° C.²² It is attacked slightly by chlorine at 600°. Fused potassium nitrate and chlorate, boiling sulphuric and hydrofluoric acids are all without action. The same is true of a boiling mixture of concentrated nitric and hydrofluoric acids. On the other hand it is attacked by fused potassium hydrate, forming potassium carbonate and silicate.

3. SILOXICON¹

There are a number of compounds, besides the carbide of silicon, that contain carbon and silicon in the same proportions as the carbide. In 1881 Schützenberger and Colson² prepared a compound of the formula SiCO by heating silicon in an atmosphere of carbon dioxide. The reaction is stated to be

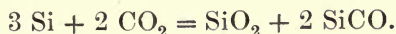

²¹ Journ. Am. Chem. Soc. **28**, 853, (1906).

²² Electrochem. Ind. **1**, 373, (1903).

¹ The name given by Acheson to compounds of carbon, silicon, and oxygen in varying amounts.

² C. R. **92**, 1508, (1881).

The same compound was formed at a higher temperature by the direct union of silicon and carbon monoxide. A compound of the formula $\text{Si}_4\text{C}_4\text{N}$ was formed in a similar way. On heating silicon in a stream of hydrogen saturated with benzene at 50° to 60° C. two compounds were obtained, one of the formula C_2Si , and the other of a variable composition, but frequently containing more oxygen than corresponds to the formula CSiO_2 .³ On heating silicon in a vapor of carbon sulphide two compounds deposited in the cold part of the combustion tube corresponding to the formulæ SiSO and SiS . In the boat containing the silicon a greenish powder was obtained which, when purified by boiling in potassium hydrate and treating with hydrofluoric acid, had the composition $\text{Si}_4\text{C}_4\text{S}$. This when heated in a current of oxygen gave $\text{Si}_4\text{C}_4\text{O}_2$. These bodies all look alike and can be distinguished only by analysis.⁴ They are pale green powders, infusible, unattackable by hydrofluoric acid or strong solutions of caustic alkali. Fused caustic alkali decomposes them, giving alkali silicate and carbonate. They resist oxidation at red heat. It will be seen that these compounds also resemble the compound obtained by Schützenberger⁴ in 1892, and which analysis showed to be SiC , though the color of the latter compound is described as a clear green. It, therefore, seems that carborundum exists in two forms, one crystalline and the other amorphous, while the amorphous form has all the appearance of other compounds containing silicon and oxygen in the same proportions as carborundum, together with a variable amount of oxygen. From the contradictory statements⁵ found in the literature it seems that the layer of material which is formed just outside the carborundum consists of silicon, carbon, and oxygen in varying amounts, and that it goes by the names of amorphous carborundum, carborundum

³ Colson, C. R. **94**, 1316, 1526, (1882).

⁴ Schützenberger, C. R. **114**, 1089, (1892).

⁵ In Min. Ind. **15**, 93, (1906), it is stated that another product of the carborundum furnace is amorphous carborundum or carborundum fire sand, and that siloxicon is a second product obtained when insufficient coke is present, consisting of carbon, silicon, and oxygen, while on p. 96 the statement is made that amorphous carborundum contains carbon, silicon, and oxygen.

fire sand, or siloxicon. The latter name is due to Acheson, who took out a patent for its production in 1903.⁶

In the manufacture of siloxicon it is important not to have sufficient carbon in the charge to reduce the silica completely, and to keep the temperature constant within certain narrow limits. For this purpose the furnace is built with more than one core, thus making the distribution of temperature more even. The charge, consisting of one third carbon and two thirds silica, is made up of powdered carbon, powdered silica, and sawdust, the silica and carbon contents of the sawdust being taken into account.

The density of siloxicon is 2.7.⁷ When heated in an atmosphere containing a large amount of oxygen to about 1470° C., it is oxidized, giving silica and carbon dioxide,⁸ while in the absence of oxygen at a higher temperature it is converted into carborundum.

Siloxicon is used to make crucibles and for furnace lining, as it is not attacked by melted metals or by slags.

4. SILICON

The manufacture of silicon is now carried out by the Carborundum Company according to patents of F. J. Tone.¹

Arc furnaces are used in which two vertical electrodes extend for a considerable depth into the charge of coke and sand. The furnace is built of fire brick lined inside with carbon. Each furnace has a capacity of 910 kilowatts, and the metal is tapped out at intervals of a few hours in ingots weighing from 600 to 800 pounds. It is made in different grades, varying from 90 to 97 per cent pure. Silicon is used principally in the steel industry in place of ferrosilicon. The production of silicon in 1908 was 600 long tons, valued at \$72,000.² Previous to its

⁶ *Electrochem. and Met. Ind.* **1**, 287, (1903).

⁷ FitzGerald, *Electrochem. and Met. Ind.* **2**, 439, (1904).

⁸ Acheson, *Electrochem. and Met. Ind.* **2**, 373, (1904).

¹ *Electrochem. and Met. Ind.* **7**, 192, (1909).

² *Min. Ind.* **17**, 13, (1908).

manufacture by the Carborundum Company the price of silicon was \$4 a pound.

Silicon can also be made in small laboratory furnaces.³

5. GRAPHITE

Graphite was known to the ancients, but up to the time of Scheele no distinction was made between it and the closely similar substance molybdenum sulphide, MoS_2 .¹ Both leave a mark on paper and were called plumbago on account of the belief that they contained lead.

In order to define graphite more definitely, Berthelot² proposed that only that variety of carbon be given this name which, on oxidation with powerful oxidizing agents at low temperatures, gives graphitic oxide. Graphitic oxide has different properties, depending on the differences in the graphite from which it is made, but all varieties are insoluble and deflagrate on heating. Amorphous carbon, when oxidized with a mixture of potassium chlorate and fuming nitric acid, the oxidizing agent used by Berthelot, is changed to a soluble substance, and diamond is not affected. This is a method of separating the three different kinds of carbon.

The artificial production of graphite by dissolving carbon in cast iron and allowing to cool slowly was first observed by Scheele in 1778.¹ It has since been made by Moissan by dissolving in iron, as well as in a number of other metals, and by heating pure sugar carbon in the electric arc.³ Diamond also may be changed to graphite by heating in the electric arc. Despretz,⁴ in his work on carbon, produced graphite by heating carbon in an electric furnace. These observations do not agree with those of Acheson, who early in his experience in the manufacture of carborundum noticed that graphite occasionally formed

³ Tucker, *Met. and Chem. Eng.* **8**, 19, (1910).

¹ Roscoe and Schorlemmer, *Treatise on Chemistry*, 3d ed. Vol. 1, p. 730.

² *Ann. de Chim. et de Phys.* (4) **19**, 393, (1870).

³ Moissan, *The Electric Furnace*, p. 61. See also FitzGerald, *Künstlicher Graphite*, Vol. 15 of the Engelhardt Monographien.

⁴ *C. R.* **28**, 755 ; **29**, 48 and 709, (1849).

next to the core,⁵ and that when coke from bituminous coal was used for the core quite a large amount of it was converted into graphite, whereas when the purer petroleum coke was used very little was so changed. The greater the amount of impurity in the coke, the larger was the amount of graphite produced. These facts led Acheson to the theory that graphite is not produced by simply heating carbon, but that a carbide must first be produced and then decomposed by a higher temperature, volatilizing the metallic element and leaving the carbon in the form of graphite. The effect of the impurities is catalytic, since the amount of graphite formed was always too great to be accounted for by the simple decomposition of the quantity of carbide corresponding to the impurity present. If only a small amount of impurity is present, it is lost by volatilization before all the carbon can be graphitized. Acheson also found that the production of graphite was greatly increased by adding a considerable quantity of any substance that could form a carbide, such as silica, aluminum oxide, lime, or iron oxide.⁶ At first the charge was made up with enough impurity to change all the carbon to carbide at once. For example, a charge would consist of 50 per cent coke, with sand, salt, and sawdust. Carborundum was then formed and by heating to a higher temperature the carborundum is decomposed, leaving graphite. It was found, however, that so much carbide-forming element was not necessary and that such substances as anthracite coal that had impurities evenly distributed through them could be converted into very pure graphite.⁷ This is at present one of the principal kinds of carbon used in this industry.

Intimate mixture of carbon and the impurity is not necessary, as the carbide-forming element can be vaporized and caused to penetrate the entire charge, thereby converting it to graphite.⁸ Petroleum coke is one form of carbon used in this process. Lumps of the coke are imbedded in powder formed from the same material and 5 per cent of iron oxide is sprinkled in. The iron oxide is reduced, iron is formed at the bottom of the furnace,

⁵ Journ. Franklin Inst. 147, 475, (1899).

⁶ U. S. Pat. 568,323, (1893).

⁷ U. S. Pat. 645,285, (1899).

⁸ U. S. Pat. 711,031, (1900).

and as the temperature is raised volatilizes and penetrates the whole charge. A very soft quality of graphite is obtained when the carbide-forming material is more than 20 per cent by weight of the charge, but less than the amount necessary to change all the carbon to carbide at once.⁹

The furnaces for graphitizing carbon in bulk have a central core similar to the carborundum furnace.¹⁰

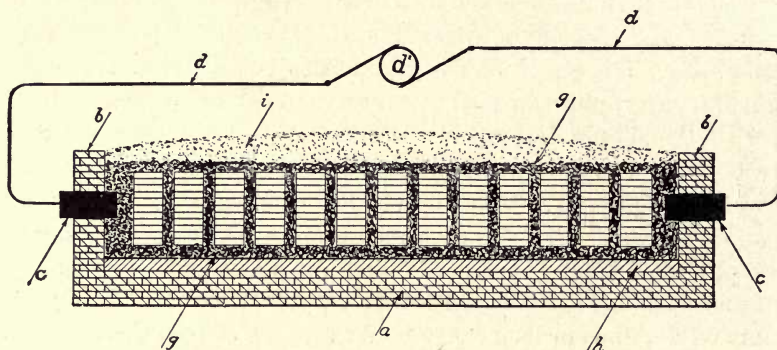

FIG. 89. — Section of graphite furnace for rectangular electrodes

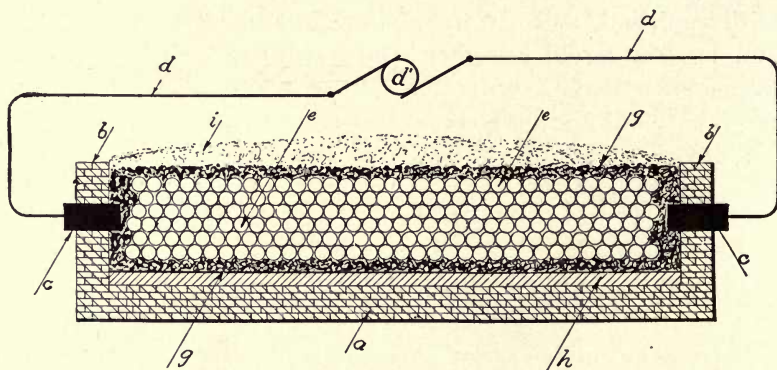

FIG. 90. — Section of graphite furnace for circular electrodes

In making graphite into electrodes, crucibles, or other finished products, a mixture of 97 per cent carbon and 3 per cent iron

⁹ U. S. Pat. 836,355, (1906).

¹⁰ Richards, *Electrochem. Ind.* 1, 54, (1902).

oxide¹¹ is mixed with a binding material consisting of water and a little molasses, and is molded into the desired form. The molded objects are then dried and placed in the furnace, where they are changed to graphite without altering their shape. Figures 89 and 90 show the methods of arranging rectangular and

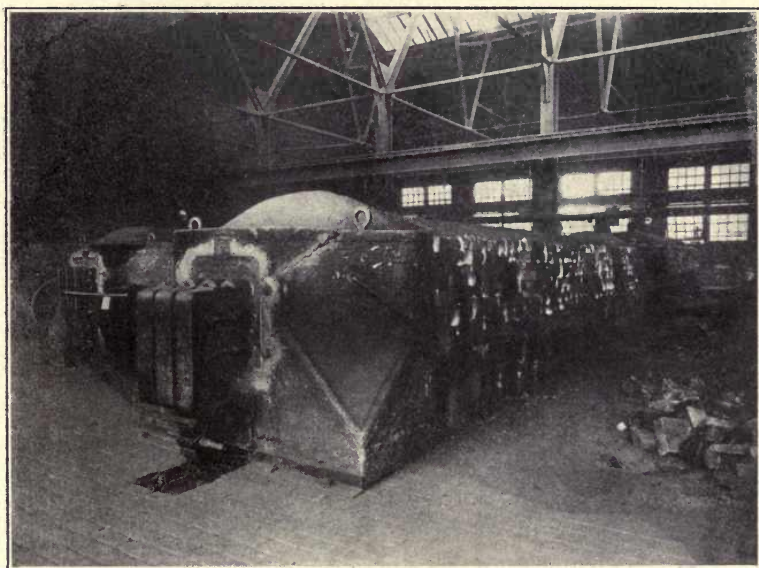

FIG. 91.—Electric furnace in which graphite is made artificially by the International Acheson Graphite Company, Niagara Falls

circular electrodes respectively. The base of the furnace consists of bricks, covered with a refractory material, *h*. The end walls, *b*, are of brick and hold the carbon electrodes, *c*. The bottom of the furnace is covered with a layer of granulated coke about 5 centimeters thick, on which the electrodes are placed in piles at right angles to the axis of the furnace, separated from each other by about one fifth the width of the electrodes. This space is then filled with granulated coke, *g*, and the furnace is covered with a mixture of coke and sand, *i*. Figure 91 is from a photograph of the furnace now used for graphitizing carbon in all forms.

¹¹ U. S. Pat. 617,929, (1898).

The following data are given by FitzGerald: ¹²

Distance between terminals	360 inches
Length of space filled by electrodes	302 inches
Length of space filled by granular carbon	58 inches
Length of electrodes under treatment	24 inches
Width of electrodes under treatment	5 inches
Height of pile of electrodes	17 inches
Initial voltage	210 volts
Initial amperage	1400 amperes
Final voltage	80 volts
Final amperage	9000 amperes

In 1902 the plant of the International Acheson Graphite Company consisted of ten furnaces and 1000 available horse power. In 1909 the plant was increased to 22 furnaces and 4000 horse power.¹³

The yearly production of manufactured graphite is given in Table 26.¹⁴

TABLE 26
The Production of Graphite

YEAR	POUNDS	VALUE IN DOLLARS
1897	162,000	10,100
1898	186,000	11,600
1899	406,000	32,500
1900	861,000	68,900
1901	2,500,000	119,000
1902	2,359,000	111,000
1903	2,620,000	179,000
1904	3,248,000	218,000
1905	4,596,000	314,000
1906	4,868,000	313,000
1907	6,924,000	484,000
1908	7,386,000	503,000
1909	6,871,000	467,000

¹² Electrochem. and Met. Ind. **3**, 417, (1905).

¹³ Electrochem. and Met. Ind. **7**, 187, (1909).

¹⁴ Min. Ind. **18**, 384, (1909). The figures in the table are rounded off.

6. CARBON BISULPHIDE

Great improvement has been made in the manufacture of carbon bisulphide by using an electric furnace in place of the small clay or iron retorts which have to be heated externally. In the old process, only a small fraction of the heat applied to the outside of the retort penetrated to the mixture of carbon and sulphur inside, and the process was so disagreeable on account of small leaks and the high temperatures of the retort room that some manufacturers gave it up altogether. E. R. Taylor,¹ however, has succeeded in overcoming these difficulties entirely by the use of the furnace shown in cross section in Figure 92, patented in 1899² and in operation at Penn Yan, New York. This furnace is 12.5 meters high and the diameter at the base 4.87 meters.³ At a height of 3.68 meters the diameter is reduced to 2.5 meters for a distance of 4.87 meters, where it narrows down to the top for the remaining length. The electrodes are at the base and are four in number, arranged 90 degrees apart. Opposite electrodes are con-

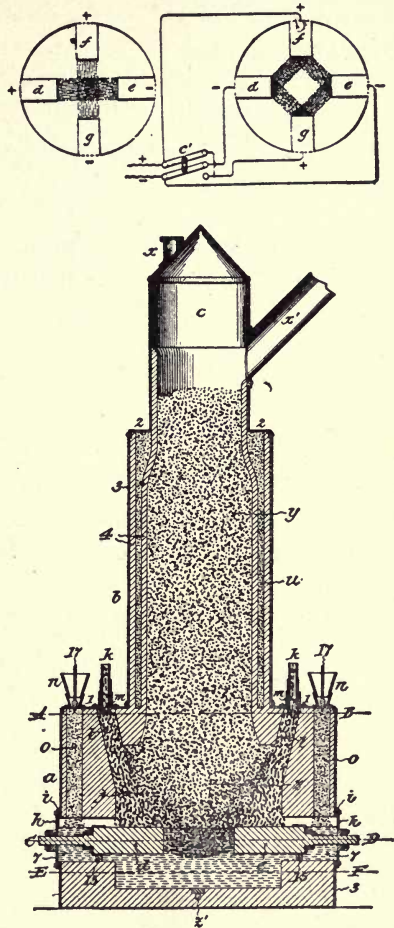

FIG. 92. — Taylor's electric furnace for making carbon bisulphide

¹ E. R. Taylor, Trans. Am. Electrochem. Soc. 1, 115, (1902) and 2, 185, (1902)

² U. S. Pat. 688,364, filed 1899, renewed 1901.

³ Haber, f. Elektroch. 9, 399, (1903).

nected to the same terminal of the alternating current machine. Wear on the electrodes is reduced to practically nothing by covering them with conducting carbon, which acts as the resistor. Charcoal is fed in at the top and sulphur through the annular spaces in the walls, thus preventing loss of heat. The sulphur is melted by the heat which would otherwise be lost through the walls, and flows down on to the electrodes, where it is heated to a temperature at which it combines with carbon. The carbon bisulphide vaporizes, passes off through the top of the furnace, and is condensed in cooling coils. The furnace is so tight that no odor is noticeable, and its operation is continuous. The production in 1903 was 3175 kilograms per day, with a consumption of 220 horse power³ and the furnace had been in operation for two and a half years with only one interruption for the purpose of cleaning out.

7. PHOSPHORUS

Phosphorus is another product the manufacture of which has been improved by the use of heat derived from electricity. The older method consists in treating calcium phosphate with sulphuric acid, which changes the triphosphate to monophosphate:

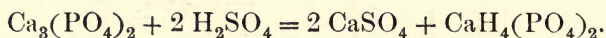

The monophosphate is then mixed with carbon and dried, by which it is changed to metaphosphate:

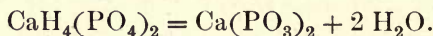

The metaphosphate is then heated in small retorts in which the following reaction takes place:

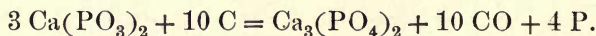

This process is imperfect in that a portion of the phosphorus is changed in the last operation to the product with which the operation is begun. Wöhler proposed the use of silica and carbon, by which all the phosphorus would be recovered, as shown by the following reaction:

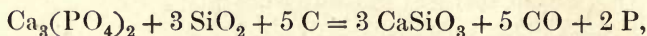

but it was never successful till the introduction of the electric furnace, on account of the difficulty of obtaining the necessary temperature and of finding vessels to withstand it.¹ In 1889 the use of electric furnaces for the manufacture of phosphorus was patented by J. B. Readman.² The process does not seem to have been immediately employed on a large scale, however.

In 1897 the firm of Allbright and Wilson built works at Niagara Falls, using 300 horse power, for making phosphorus in the Readman-Parker furnace.³ The furnaces are illustrated in Figures 93 and 94. Each produces 170 pounds a day.

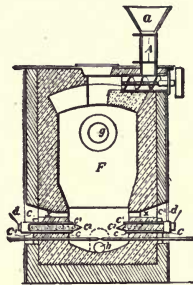

The Readman-Parker electric furnace for producing phosphorus

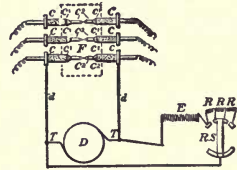

FIG. 94.—Horizontal section

Over half the world's production of phosphorus is now made in electric furnaces.⁴

8. ALUNDUM

Fused aluminum oxide, chemically identical with corundum, has received the trade name of *Alundum*. The process for making this abrasive in the electric furnace was patented in 1900 by C. B. Jacobs.⁵ His furnace was rectangular in shape, made of sheet iron and brick, and was lined inside with carbon. An arc was formed between four pairs of electrodes near the movable bottom of the furnace. As the aluminum oxide fused and covered the bottom of the furnace, it was gradually lowered, thereby making a layer of fused aluminum oxide which cooled slowly. This process gives the abrasive a hardness greater than corundum.

¹ Min. Ind. 14, 494, (1905).

³ Min. Ind. 6, 537, (1897), 7, 557, (1898).

² U. S. Pat. 147,943, (1889).

⁴ Min. Ind. 9, 768, (1900).

⁵ U. S. Pat. 659,926, (1900).

The Norton Emery Wheel Company of Worcester are the sole manufacturers of alundum. Their factory is at Niagara Falls. Bauxite, the raw material, is dehydrated before feeding into the furnaces. The yearly production is given in Table 27.⁶

TABLE 27
Production of Alundum

YEAR	POUNDS	VALUE IN DOLLARS
1904	4,020,000	281,400
1905	3,612,000	252,840
1906	4,331,000	303,190
1907	6,751,000	405,090
1908	3,160,000	189,600
1909	13,758,000	814,680

9. ALUMINUM

With the exception of silicon and oxygen, aluminum is the most widely distributed element in nature,¹ occurring principally as silicates in clays. Only a limited number of its compounds can be used for extracting aluminum, however, chief among which is bauxite, AlO_3H_3 . The name *aluminum* is derived from *alumen*, a term applied by the Romans to all bodies of astringent taste.

The attempts to isolate aluminum date from 1807, when Davy was unsuccessful in applying to this problem the method employed in isolating the alkali metals. Oersted seems to have made aluminum in 1824 by heating the chloride with potassium amalgam. Wöhler in 1827 obtained aluminum by decomposing the anhydrous chloride with potassium, and in 1864 Bunsen and Deville obtained it independently by the electrolysis of fused aluminum chloride. Previous to the production by the method of electrolysis now used, the halide salts were the source of the metal and were reduced by metallic sodium.

Alumina can be reduced by carbon to metallic aluminum by

⁶ Min. Ind. 18, 25, (1909).

¹ Thorpe, Dic. of Chem. 1, 63, (1890).

heating to a temperature above 2100°C .,² but it is always mixed with aluminum carbide, from which it can be removed by remelting, and obtained in a compact form. This is evidently not a method of making aluminum that could be satisfactorily carried out commercially. If, however, a metal such as copper is added to the mixture, the aluminum can be obtained as an alloy with this other metal. This process was patented in 1884 by the Cowles brothers.³ The cheap production of pure aluminum, however, was made possible by the discovery of C. M. Hall⁴ that alumina, dissolved in a molten mixture of aluminum fluoride and the fluoride of another metal, forms an electrolyte which may be decomposed by an electric current, liberating aluminum at the cathode and oxygen at the anode. Hall's original patent specifies a mixture of 169 parts by weight of aluminum fluoride and 116 parts of potassium fluoride, corresponding to the formula $\text{K}_2\text{Al}_2\text{F}_8$, and states that this may be made more fusible by replacing part of the potassium fluoride by lithium fluoride, or by simply adding the latter to the above mixture. Another receipt is 84 parts of sodium fluoride to 169 of aluminum fluoride, which may be made by adding aluminum fluoride to cryolite, a mineral of the composition $\text{AlF}_3 \cdot 3\text{NaF}$. He placed the carbon-lined crucible in a furnace, melted the mixture, added alumina, and electrolyzed with an anode of copper or carbon. Copper is said to be covered with an oxide which protects it from further action.

Subsequent patents show that these mixtures worked well at first, but became less efficient after being electrolyzed some time. A dark substance formed which interfered with the electrolytic action, increased the resistance, and necessitated a change of the bath. This Hall attempted to overcome by using a bath of calcium and aluminum fluoride of the composition $2\text{AlF}_3 \cdot \text{CaF}_2$.⁵ This increases the density to such an extent that the aluminum floats to the surface. It evidently

² Hutton and Petavel, *Phil. Trans.* **207**, 421, (1907); Askenasy and Lebedeff, *Z. f. Elektroch.* **16**, 565, (1910).

³ U. S. Pat. 319,795, (1884). Also *Proc. Soc. of Arts*, 1885-1886, p. 74.

⁴ U. S. Pat. 400,664 and 400,766, filed 1886.

⁵ U. S. Pat. 400,664, filed 1888.

was not satisfactory, for subsequently a bath made up of 234 parts calcium fluoride, 421 parts cryolite, 845 parts aluminum fluoride, and 3 to 4 per cent calcium chloride was patented.⁶ It was claimed that the chloride prevented the clogging of the bath even when in continuous operation. It is evident the dark color must have come from carbon, as no clogging occurred with any of the baths when a metal was used as cathode.⁷ In this case, of course, an alloy of aluminum would be obtained.

As carried out on a large scale, the crucibles were never heated externally, but simply by the passage of the current itself. This double use of the current to keep the bath melted and to electrolyze at the same time was patented by Charles S. Bradley.⁸ In describing his process, cryolite is considered the electrolyte. The two patents of Hall and Bradley taken together represent the process as actually carried out.

In 1887 Paul Héroult patented a very similar process for producing aluminum alloys.⁹ This process consisted in fusing pure alumina and keeping it in the fused state by the current, which at the same time decomposes the oxide electrolytically. The cathode is a melted metal, with which the aluminum is to be alloyed, and the anode is carbon. Serious objections were found to using any flux. Among those tried and discarded was cryolite. The patent states that satisfactory results were obtained with a carbon crucible 20 centimeters in depth and 14 centimeters in diameter at the top, a carbon anode 5 centimeters in diameter, and a current of 400 amperes at from 20 to 25 volts. This voltage is four or five times that specified by Hall. Bradley's patent for the simultaneous use of the current for electrolysis and heating was therefore earlier than Héroult's, and as it is stated in Héroult's patent that he had failed to get good results when any flux was mixed with the aluminum oxide, there is no question of priority over Hall's patents. It does not seem, therefore, that the statement often met with, that the processes

⁶ U. S. Pat. 400,666, filed 1888.

⁷ U. S. Pat. 400,667, filed 1888.

⁸ U. S. Pat. 464,933, filed 1883, granted 1891.

⁹ U. S. Pat. 387,876, filed December, 1887.

of Hall and Héroult are identical, is borne out by the patents.¹⁰ The Hall patents for the composition of the bath expired in 1905 and the Bradley patents in 1909.¹¹

The only producer of aluminum in this country is the Aluminum Company of America, previous to 1907 known as the Pittsburgh Reduction Company.¹² This company controls three plants, situated at Niagara Falls, Massena, New York, and Shawinegan Falls, Canada. These plants were enlarged in capacity in 1907 to 40,000 horse power, 20,000 horse power, and 15,000 horse power respectively.¹³ The six European companies producing aluminum show a maximum consumption of 97,500 horse power.¹³ The furnaces used by the American company consist of cast iron troughs lined with carbon.¹⁴ The anode is composed of 48 carbon rods 3 inches in diameter and 15 inches long, manufactured by the aluminum company for its own use.¹² Each furnace takes about 10,000 amperes at about 5.5 volts. The yield is 1.75 pounds of aluminum per horse power day.¹⁴ The metal sinks to the bottom and is drawn off, while alumina is thrown in as it is used up. The temperature of the bath may be inferred from the following melting points of mixtures of cryolite and alumina.¹⁵

TABLE 28
Melting Points of Mixtures of Cryolite and Alumina

PER CENT CRYOLITE	M. P., DEGREES CENTIGRADE	PER CENT CRYOLITE	M. P., DEGREES CENTIGRADE
100	1000	92	992
97	974	90	980
96	960	85	994
95	915	80	1015
94	960		
93	982		

¹⁰ See for example Pring, *Some Electrochemical Centres*, p. 26 (1908).

¹¹ *Min. Ind.* 17, 23, (1908).

¹³ *Min. Ind.* 6, 11, 15, (1907).

¹² *Min. Ind.* 15, 11, (1906).

¹⁴ *Min. Ind.* 14, 15, (1905).

¹⁵ Pyne, *Trans. Am. Electrochem. Soc.* 10, 163, (1906).

The production of aluminum in the United States and Canada is given in Table 29.¹⁶

TABLE 29
Production of Aluminum in the United States and Canada

YEAR	POUNDS	VALUE IN DOLLARS	VALUE PER POUND IN DOLLARS
1897	4,000,000	1,400,000	0.35
1898	5,200,000	1,690,000	0.33
1899	6,500,000	2,113,000	0.33
1900	7,150,000	2,289,000	0.32
1901	7,150,000	2,238,000	0.31
1902	7,300,000	2,285,000	0.31
1903	7,500,000	2,325,000	0.31
1904	7,700,000	2,233,000	0.29
1905	11,350,000	3,632,000	0.32
1906	14,350,000	5,166,000	0.36
1907	26,000,000	10,920,000	0.42
1908	13,000,000	4,095,000	0.32
1909	15,000,000	3,345,000	0.22

The total production of the world for 1909 is estimated at 24,200 metric tons, or 53,300,000 pounds. The cost of manufacture excluding amortization is said to be about 15 cents a pound.¹⁶

On reading a description of the different expedients patented by Hall to prevent the baths from clogging, becoming discolored, and ceasing to operate properly, it is not surprising that difficulties are encountered on attempting to use the reduction of aluminum as a laboratory experiment. Haber and Geipert¹⁷ succeeded in a few runs, though in the last run they met with irregularities. The immediate difficulty that stops an experiment on a small scale is a polarization at the anode, due to a thin film of gas,¹⁸ which reduces the current to such a point that the bath freezes up. If a higher voltage is applied it heats the

¹⁶ Min. Ind. 18, 17, (1909).

¹⁷ Z. f. Elektroch., 8, 1, and 26, (1902).

¹⁸ Thompson, Electrochem. and Met. Ind. 7, 19, (1909). Also Neumann and Olsen, Met. and Chem. Eng. 8, 185, (1910).

bath too much locally and burns up the aluminum. By the use of an anode with a large area this can be prevented to a certain extent.¹⁸

One of the principal uses for aluminum is in the iron and steel industry as a reducing agent.¹⁹ As is well known, it has replaced copper, tin, and brass to a great extent in the manufacture of a large number of objects in which lightness is desired.

10. SODIUM AND POTASSIUM

Sodium and potassium were first isolated by Davy¹ by electrolyzing the corresponding fused hydrates. In this process sodium is liberated at the cathode while the negatively charged hydroxyl ion is liberated at the anode. Two of these ions when discharged react together according to the reaction:

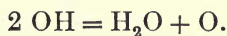

A certain amount of metallic sodium dissolves in the hydrate, diffuses to the anode, and coming in contact with the water reacts to form hydrate with the liberation of hydrogen.² It is therefore possible to have both hydrogen and oxygen evolved at the anode, resulting in explosions. At the same time sodium peroxide (Na_2O_2) is formed. The water formed at the anode is not driven off by the temperature of the bath; on the contrary it has been found that very moist air is dried to a certain extent in passing through the melted hydrate.²

The apparatus nearly universally used for the production of sodium and potassium is due to Hamilton Young Castner³ and is shown in Figure 95. It consists in a cast-iron box with an iron cathode, *H*, insulated from the box and held in an iron pipe fastened into the bottom of the cell. The space between the pipe and electrode is filled with melted hydrate which is allowed to solidify before the electrolysis is begun. Surrounding the

¹⁹ For a detailed account of the various purposes to which aluminum is applied, see A. E. Hunt, Journ. Franklin Inst., Vol. 144, (1897).

¹ Phil. Trans., 1808, pp. 5 and 21.

² Lorenz, Elektrolyse Geschmolzener Salze, I, 25, (1905).

³ U. S. Pat. 452,030, filed 1890.

cathode is a fine iron gauze diaphragm, *M*, outside of which is the iron anode, *F*. The metal is liberated on the cathode and floats to the surface of the hydrate, where it collects in an iron cylinder forming a continuation of the diaphragm. It is removed by an iron spoon with fine perforations, which allow the hydrate to drain off, but which holds the metal. The hydrate is added as it is used up, and the process is continuous. An important point is to maintain the temperature as low as possible, not over 20° above the melting point of the hydrate. The

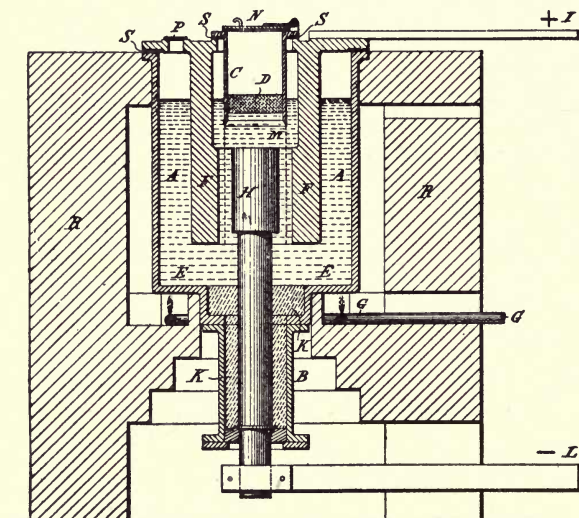

FIG. 95. — Castner's cell for producing sodium and potassium

higher the temperature the less the yield in metal, due of course to its greater solubility in the melted hydrate. As the temperature increases, the yield becomes less, until it finally reaches zero. At best the current efficiency is said to be only about 45 per cent.⁴ In the patent gas heating is provided, though it is stated that the current can be so regulated as to keep the proper temperature without external heating.

There are other processes very similar to that of Castner, some of which are in use,⁵ which will be omitted as presenting

⁴ Ashcroft, Trans. Am. Electrochem. Soc. 9, 123, (1906).

⁵ See H. Becker, Die Elektrometallurgie der Alkalimetalle, p. 52, (1903).

no new principles; but the principle of the following process, due to Ashcroft,⁴ will be described because of its novelty and in spite of the fact that it does not seem as yet to have been carried out on a commercial scale. Melted sodium chloride is electrolyzed with a lead cathode. The lead sodium alloy formed is let into another cell containing melted sodium hydrate. Here the lead alloy acts as the anode and forms sodium hydrate with the hydroxyl ions liberated on its surface, thus avoiding the formation of water and oxygen. At the cathode sodium is liberated and removed. To decompose the chloride 7 volts are required, and 2 volts for the hydrate when this anode is used. The voltage is therefore about twice that required in the Castner cell; but as the current efficiency is about 90 per cent, or twice that in the Castner process, the yield per unit of power is the same in the two cases. The advantages claimed by Ashcroft are shown in the following table:

	ASHCROFT PROCESS	CASTNER PROCESS
Cost of material	0.5 cent per pound	5 cents per pound
Cost of power per pound of sodium . .	1 to 5 cents	1 to 5 cents
Labor	1 cent	2½ cents
Upkeep and standing charges	2.5 cents	2 cents
Total	5 to 9 cents per pound	10 to 14 cents per pound

The saving comes in the greater cheapness of the raw material, and there would be a further saving in the value of the chlorine produced.

The world's production of sodium in 1907 is estimated at from 3500 to 5000 tons.⁶ In the United States there are two companies producing about 2000 tons a year. The Electrochemical Company at Niagara Falls uses the Castner process, while the Virginia Electrolytic Company at Holcomb Rock, Virginia, is said to employ a process in which fused sodium chloride is electrolyzed.

⁶ Min. Ind. 17, 772, (1908).

A large part of the sodium made is consumed in the manufacture of sodium cyanide and sodium peroxide. The process for cyanide⁷ consists in passing ammonia over the metal heated in an iron retort to 300 to 400° C., forming sodamide:

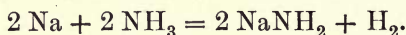

This is then treated with charcoal previously heated to redness, giving the cyanide



A recent purpose to which the metal has been put is the drying of transformer oils. Ashcroft⁴ believes a reduction in the price may increase its uses materially, such as making primary cells, obtaining hydrogen by the decomposition of water, and even for transmitting electric power. The specific conductivity is only about one third that of copper,⁸ but if equal weights of metal are considered between two given points, the conductivity would be three times that of copper, as the density of copper is about nine times that of sodium. Some experiments have actually been carried out in power transmission with the sodium protected in iron pipes.⁹

11. CALCIUM

Calcium was first isolated by Davy in 1808, by combining the methods previously used by him with those of Berzelius and Pontin.¹ Lime was mixed with red oxide of mercury, slightly moistened and placed on a piece of platinum. A globule of mercury in a cavity at the top acted as negative electrode, giving on electrolysis an amalgam of calcium, from which the mercury was distilled.

Bunsen² obtained calcium in very small quantities containing a little mercury by electrolyzing with a high current density a boiling concentrated solution of calcium chloride

⁷ Roscoe and Schorlemmer, **2**, 276, (1907).

⁸ Landolt-Börnstein Tables, 3d ed.

⁹ Betts, *Min. Ind.* **15**, 688, (1906) and *El. World*, **48**, 914, (1906).

¹ *Alembic Club Reprints*, No. 6, p. 48, *Ostwald Klassiker*, No. 45.

² *Pogg. Ann.* **91**, 623, (1854), in an article on the preparation of chromium.

acidified with hydrochloric acid. The cathode was amalgamated platinum wire. Rathenau³ was first to obtain calcium in a compact form in fairly large quantities by a rather original method. The bath consists of calcium chloride very little above its melting point. An iron rod is used as cathode, which just touches the surface of the bath. As the melting point of calcium is a little higher than that of the bath, it solidifies on depositing and adheres to the rod, which is gradually raised, thus drawing out a stick of calcium with a certain amount of chloride adhering to it. The melting point of the electrolyte may be lowered by adding

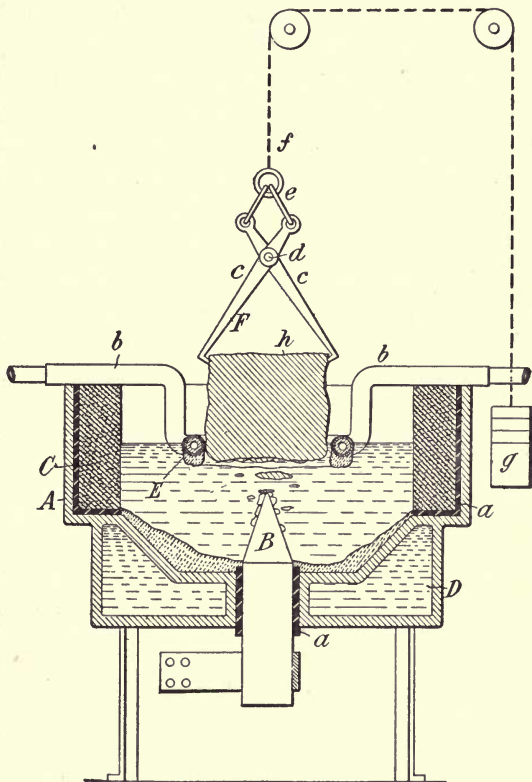

FIG. 96. — Cell of Seward and von Kügelgen for the production of calcium

fluoride. The anode may be a carbon crucible in which the salt is contained,⁴ though Rathenau does not specify his arrangement. The experience of the author has been that this is a much better plan than that adopted by P. Wöhler,⁵ where the salt is held in an iron vessel and a carbon anode dips into the bath. Due to the

³ Z. f. Elektroch. 10, 508, (1904).

⁴ J. H. Goodwin, Proc. Am. Phil. Soc. 43, 381, (1904).

⁵ Z. f. Elektroch. 11, 612, (1905).

high anode current density in this case, the gas is more likely to stop the current by polarization. The heat due to the current is sufficient to keep the salt melted.

Calcium is made in this country only by the Virginia Electrolytic Company at Holcomb Rock, Virginia.⁶ The process is supposed to consist⁷ in electrolyzing melted calcium chloride in a cell patented by Seward and von K \ddot{u} gelgen,⁸ shown in Figure 96. This cell consists of a circular iron box, *A*, through the bottom of which projects a conical iron cathode, *B*, insulated from the box by insulating material, *aa*. The anode, *C*, is a carbon lining also insulated from the iron box. Above the cathode and concentric with it is a water-cooled collecting ring, *E*, which separates the metal rising to the surface from the chlorine. The metal accumulates till the ring is full. The top layer is solid, due to the cooling of the air, and the bottom is soft or melted. The solid part is fastened to a hook, *F*, and gradually drawn out.

The production of calcium by the Virginia Electrolytic Company in 1907 was 350 pounds, valued at \$613, and about the same amount was produced in 1908.⁶

⁶ Min. Ind. 17, 99, (1908).

⁷ Min. Ind. 16, 131, (1907).

⁸ U. S. Pat. 880,760.

CHAPTER XIII

THE ELECTROMETALLURGY OF IRON AND STEEL

1. GENERAL DISCUSSION

BEFORE giving an account of the application of electric heating to the iron and steel industry, a short sketch of the older methods of winning and refining iron will not be out of place.

The extraction of iron from its ores, consisting principally of oxides of iron mixed with clay, silica, and other impurities, is accomplished by reducing the ore with some form of carbon, usually coke. This operation is carried out in a blast furnace, a circular brick structure lined with silicious brick, and varying in size from 48 feet to 106 feet in height, and from 8 feet to 15 feet in diameter at the base. Figure 97 shows the elevation of a blast furnace. It consists of three principal parts: (1) the crucible or hearth at the base, cylindrical in shape, (2) the bosh directly above, which gradually widens, and (3) the stack, from which point the furnace contracts for the rest of its height. The furnace is filled with alternate layers of ore, coke, and flux, the latter usually consisting of calcium carbonate. The object of the flux is to form a fusible slag with the constituents of the ore which are not reduced by the carbon, such as silica and alumina. The heat necessary to raise the charge to a temperature high enough for reduction is produced by the combustion of the coke in the charge, by means of air forced in through the tuyères, *F*, projecting through the wall of the furnace just below the bosh. The carbon therefore serves the double purpose of furnishing the heat and of reducing the ore.

The highest temperature of the furnace is near the tuyères and a few feet above them; in this region the slag and iron melt and drop into the crucible, where they separate, the slag

floating on the iron. These are drawn off from time to time through the tap holes *G* and *H*, and fresh material is fed into the top of the furnace by mechanical means. The iron thus

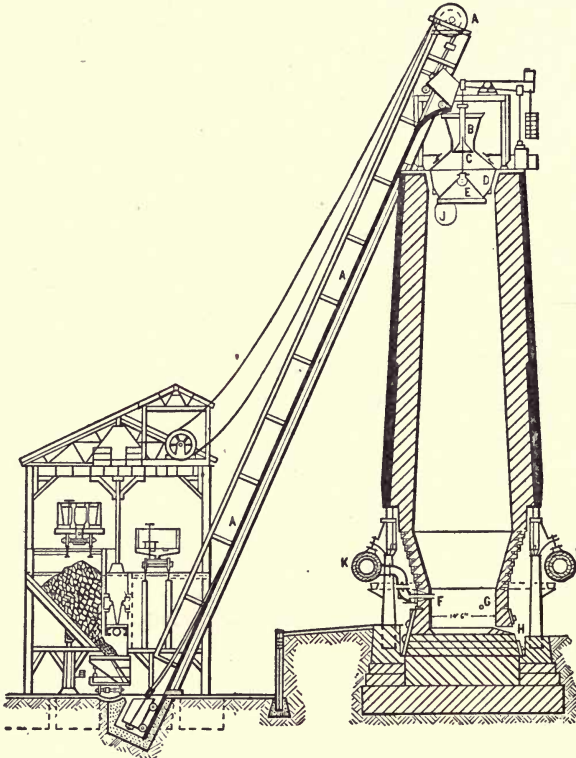

FIG. 97. — Elevation of blast furnace

produced is known as pig iron, and contains from three to four per cent of carbon, as much as four per cent of silicon, and one per cent of manganese, and a few hundredths of one per cent of sulphur and phosphorus. Only about 23 per cent of the pig iron made in this country is used without subsequent purification.¹ Purification or refining of iron is accomplished by oxidizing the impurities and causing them to form a slag, which floats on the iron.

¹ Stoughton, *The Metallurgy of Iron and Steel*, p. 52.

One method of refining consists in blowing air through the liquid metal in a Bessemer converter. The lining of the converter may be either basic, consisting of calcined dolomite (calcium and magnesium oxides), or acid, consisting of silica. The Bessemer method is very rapid, silicon and manganese oxidizing in about four minutes from the time when the air is first blown in. The carbon then begins to oxidize to carbon monoxide, which boils up through the metal and comes out of the converter in a long flame. In about six minutes from the time the carbon begins to oxidize, it is reduced to approximately 0.04 per cent, and the operation is then stopped. The temperature is higher at the end of the process than at the start, due to the heat of oxidation of the impurities. A calculated amount of carbon is then added, also 1.5 per cent of manganese to remove the oxygen, and 0.2 per cent of silicon to remove the other gases. The steel is then cast into molds.

The second method of refining is known as the open hearth or Siemens-Martin process. This consists in melting the pig iron in a large reverberatory furnace, whose lining may be either basic or acid. The oxidation of the impurities is brought about by the excess of oxygen in the furnace gases over that necessary to burn the gases. A much longer time is required for purification by the open hearth than by the Bessemer process. In the basic open hearth process enough lime is added to form a very basic slag, which, unlike an acid slag, will dissolve phosphorus. The lining must also be basic to prevent its being eaten away by the basic slag.

The third method of purification is known as the puddling process, in which the iron is melted on the hearth of a reverberatory furnace lined with oxides of iron. The pig iron is charged by hand through the doors of the furnace and is melted as quickly as possible. During melting, silicon and manganese go into the slag, as well as some of the oxide of the lining. Iron oxide is then added in order to make a very basic slag; the charge is thoroughly mixed, and the temperature is lowered to the point where the slag begins to oxidize the phosphorus and sulphur before the carbon. After the removal of these

impurities, the carbon begins to oxidize and comes off as carbon monoxide, which burns on coming in contact with the air. During this time the puddler stirs the charge vigorously with a long iron rabble, an instrument shaped like a hoe. As the iron becomes pure, its melting point rises and it begins to solidify, since the temperature of the furnace is below the melting point of pure iron. The iron is finally removed in the form of a ball dripping with slag, and is put through a squeezer to remove the slag as much as possible. This product is known as wrought iron. It is converted into steel by two methods, (1) the cementation, and (2) the crucible process. In the cementation process the wrought iron is carburized by heating, without melting, in contact with carbon. The carbon slowly penetrates the iron and changes it to steel. In the crucible process the wrought iron is cut up into small pieces and is melted in covered crucibles with the desired amount of carbon or other element that is to be alloyed with it. When the process is finished the steel is cast into molds. By thus remelting the iron, the slag is removed and the required amounts of carbon, silicon, and manganese are added.

2. THE ELECTROTHERMIC REDUCTION OF IRON ORES

The conditions under which electric heating can economically be substituted for the heat of combustion of coke in the reduction of iron ores are purely local. In places where iron ore can be obtained cheaply, where metallurgical coke is expensive, where water power is cheap, and where iron would have to be hauled from a great distance to supply the local demand, it may be possible to produce iron by electric heating at a price low enough to compete with that brought from a distance. These conditions exist in Canada, Sweden, and California.¹

The first attempt to apply electric heating to the metallurgy of iron was made in 1853 by Pinchon,² and in 1862 Monkton took a patent in England for the reduction of ores by the

¹ Eugene Haanel, *Trans. Am. Electrochem. Soc.* **15**, 25, (1909), and P. McN. Bennie, *ibid.* p. 35.

² B. Neumann, *Electrometallurgie des Eisens*, p. 3, (1907).

electric current. Sir William Siemens again called attention to this subject in a lecture before the Society of Telegraph Engineers in London in 1880.³ The first, however, to show by experiments on a large scale that iron can be reduced commercially by electric heating was the Italian army officer, Major Stassano.⁴ Patents were taken out by him in the year 1898 in different countries, consequently this date

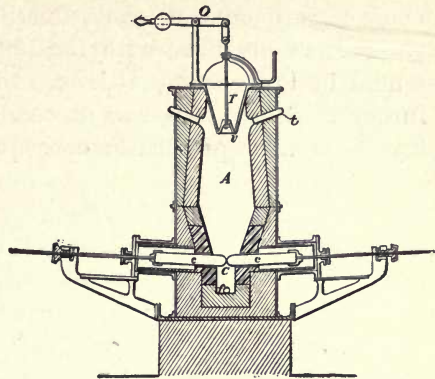

FIG. 98. — Stassano's first furnace at Rome

marks the beginning of the actual application of electricity to the metallurgy of iron. The contraction of the carbide industry in 1899 to 1900, due to overproduction, leaving idle a number of water-power stations in southeastern France, for which some new application of electric power was needed, also hastened the introduction of electric heating in the iron industry.⁵

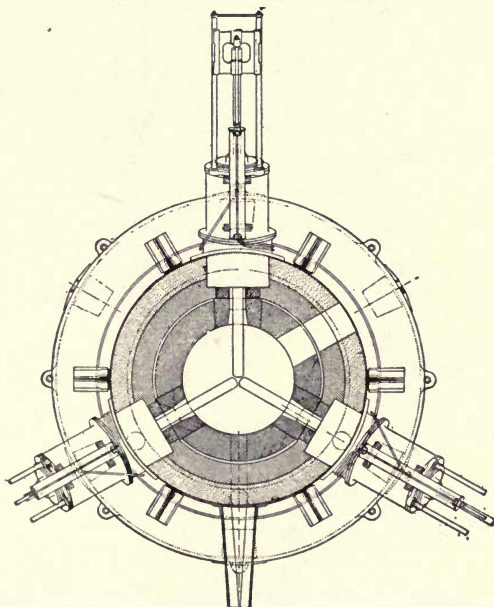

FIG. 99. — Horizontal section of Stassano's electric furnace at Darfo

Stassano's prelim-

³ *Elektrotech. Z.* 1, 325, (1880).

⁴ Askenasy, *Technische Elektrochemie*, 94, (1910).

⁵ J. B. C. Kershaw, *Electrometallurgy*, p. 175, (1908).

inary experiments on the reduction of iron ore were carried out at Rome in 1898,⁶ with the 150 horse power furnace represented in Figure 98. It is seen to resemble an ordinary blast furnace. Since there was no combustion of carbon, no reducing gases were produced; consequently, in order to bring the

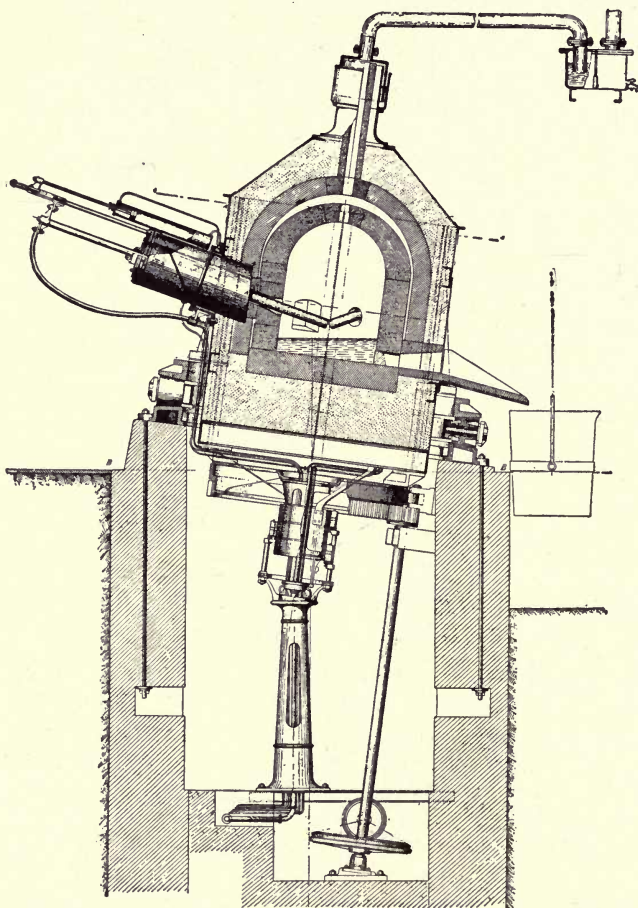

FIG. 100. — Vertical section of Stassano's electric furnace at Darfo

carbon and ore in intimate contact, they were powdered, mixed, and made into briquettes with pitch as a binder. The furnace

⁶ See an article by Stassano reprinted in Haanel's Report, p. 178, (1904).

was first heated without a charge; an iron grating was then placed in the furnace 20 centimeters above the arc, and the mixture was charged in from the hopper at the top and was held up by the grating. The grating eventually melted, and the ore in contact with it was reduced. In this state the mixture which lay on the grating became fused and formed an arch, which supported the charge even when the grating melted away. As the heat from the arc penetrated the mass above the arch, iron was reduced and dropped into the crucible below. In the course of twelve hours the arch increased so in thickness, due to the slag produced, that it prevented the efficient heating of the charge above. Consequently this form of furnace was given up, and one was adopted in which the material was introduced below the arc, as is done in refining furnaces. The final form adopted at Darfo,

in northern Italy, is shown in Figures 99 and 100. Movement of the entire chamber in which the fusion takes place is effected by rotating about an axis inclined to the vertical. The electricity is conducted to the furnace by sliding contacts on two metal rings at the top of the furnace. This furnace worked perfectly satisfactorily, even when run for several days. The most difficult questions to decide were the relation

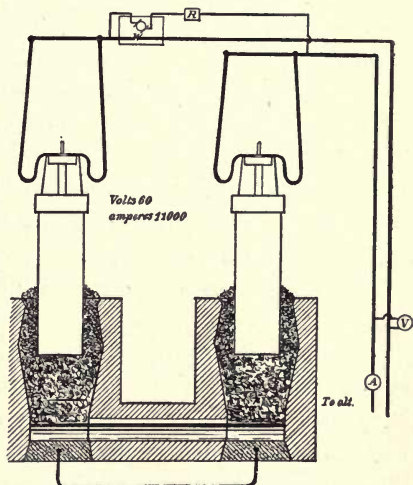

FIG. 101. — The Keller electric furnace for reducing iron ore

between the size of the cavity and the energy to be supplied, and the manner of making the refractory lining. The carbon electrodes were 1.5 meters long and lasted sixty consecutive hours. The furnace was supplied with 1000 amperes at 100 volts, and since the value of the cosine of the phase difference between electromotive force and current was 0.8, the power

consumed was 80 kilowatts. The best yield with this furnace was one kilogram of soft iron for 3.2 kilowatt hours, and the iron obtained was always over 99 per cent pure. The ore, which was from the island of Elba, had the following composition :

Fe ₂ O ₃	93.020 per cent
MnO	0.619 per cent
SiO ₂	3.792 per cent
CaO, MgO	0.500 per cent
Sulphur	0.058 per cent
Phosphorus	0.056 per cent
Moisture	1.720 per cent

According to Stassano, the plant at Darfo was shut down for reasons not directly connected with the success of the process.

The Keller furnace for making pig iron is shown in Figure 101. This furnace was seen in operation by the Canadian Commission at Livet, France, in 1904. It⁷ consists of two iron castings of square cross section, forming two shafts communicating with each other at their lower ends by a lateral canal. The castings are lined with refractory material. The base of each shaft is provided with a carbon block, these two blocks being connected to each other outside the furnace by copper bars. On starting, before there is metal in the canal, the current flows from one block to the other through the copper bar, but when enough metal has been reduced to partially fill the canal, most of the current flows through the melted metal. The electrodes are 1.4 meters long and 85 by 85 centimeters in cross section. The cost of electrodes per metric ton of pig iron is estimated by Keller at 3.85 francs. The energy absorbed per metric ton of pig iron in a furnace supplied with 11,000 amperes at 60 volts was 0.390 kilowatt year for the run, and with a smaller furnace supplied with 7000 amperes at 55 volts it was 0.186 kilowatt year for the run.⁸

⁷ Haanel's Report, p. 15, (1904).

⁸ Haanel's Report, p. 20, (1904).

Following the tour of inspection by the Canadian Commission, an investigation was carried out for the Canadian government in 1906 by Héroult, to see (1) whether magnetite could be economically smelted by the electrothermic process; (2) whether ores containing sulphur, but not manganese, could be made into pig iron of marketable composition; and (3) whether charcoal could be substituted for coke. The furnaces were slightly modified as the investigation proceeded, and the final form is shown in Figure 102. It consists of a cylindrical iron casting $\frac{1}{4}$ inch thick, bolted to a bottom plate of cast iron 48 inches in diameter. The casting was made in two sections bolted together by angle irons. In order to make inductance small, the magnetic circuit was broken by replacing a vertical strip of 10 inches width in the casting by copper.

Rods of iron were cast into the bottom plate to secure good contact with the carbon paste rammed into the lower part of the furnace. The electrodes, 6 feet long and 16 by 16 inches in cross section, were manufactured by a process of Héroult's and were imported from Sweden. The pipe *k* was for the purpose of cooling the electrode holder by a current of air. The current was between 4000 and 5000 amperes at 36 to 39 volts, and the power factor was 0.919. The ores used in the experiments below were of the following composition:

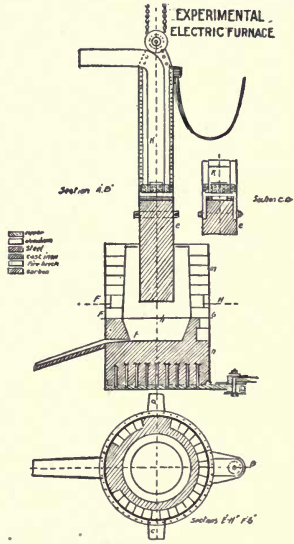

FIG. 102.—Héroult experimental furnace at Sault Ste. Marie, for reducing iron ore

TABLE 30

Composition of Ores investigated by Héroult for the Canadian Government

	HEMATITE	MAGNETITE			ROASTED PYRROTITE	TITANIFEROUS IRON ORE
		1	2	3		
Fe	62.23	56.69	55.85	58.29	45.80	43.59
SiO ₂	5.42	6.20	6.60	4.00	10.96	7.12
Fe ₂ O ₃	88.90	55.42	60.74	55.31	65.43	30.30
FeO	—	23.04	17.18	25.20	—	28.78
Al ₂ O ₃	2.51	2.56	1.48	2.24	3.31	7.00
CaO	0.61	2.00	2.48	2.40	3.92	1.00
MgO	0.30	6.84	5.50	4.00	3.53	4.14
Mn	0.16	—	—	—	—	—
MnO	—	0.258	0.13	—	—	—
P	0.044	0.01	0.016	0.415	0.016	0.028
S	0.0002	0.05	0.57	0.45	1.56	0.04
CO ₂ and unde- termined	—	3.609	4.923	5.45	—	—
Loss on ignition	2.48	—	—	—	—	—
Cu	—	—	—	—	0.41	—
Ni	—	—	—	—	2.23	—
TiO ₂	—	—	—	—	—	17.82
Cr ₂ O ₃	—	—	—	—	—	2.50
	100.426	100.00	100.00	100.00	—	99.648

The consumption of the electrode in these experiments was 8.9 kilograms per metric ton of pig iron produced. The yield per unit of energy varied somewhat, but was approximately 0.25 kilowatt year of 365 days per metric ton of pig iron.

The results of these experiments were:

1. Canadian ores, chiefly magnetites, can be as economically smelted as hematites by the electrothermic process.
2. Ores of high sulphur content can be made into pig iron containing only a few thousandths of one per cent of sulphur.
3. The silicon content can be varied as required for the class of pig iron to be produced.

4. Charcoal which can be cheaply produced from mill refuse or wood which could not otherwise be utilized, and peat coke, can be substituted for coke without being briquetted with the ore.
5. A ferro-nickel pig can be produced practically free from sulphur, and of fine quality, from roasted nickeliferous pyrrhotite.
6. Titaniferous iron ores containing up to five per cent can be successfully treated by the electrothermic process.

These results demonstrated the feasibility of applying the electrothermic process to the reduction of iron ores.⁹ All that was necessary to put it on a commercial basis was the construction of a furnace that could be economically and successfully used in practice. This was undertaken by three Swedish engineers, Messrs. Grönwall, Lindblad, and Stålhane, at Domnarfvet, Sweden. They concentrated their attention on the construction of a furnace following the suggestions contained in the report of Héroult's experiments for the Canadian government, which were, (1) charging by labor-saving machinery, (2) collection and use of carbon monoxide produced by the reduction of the ore, (3) automatic regulation of electrodes, and (4) a sufficiently

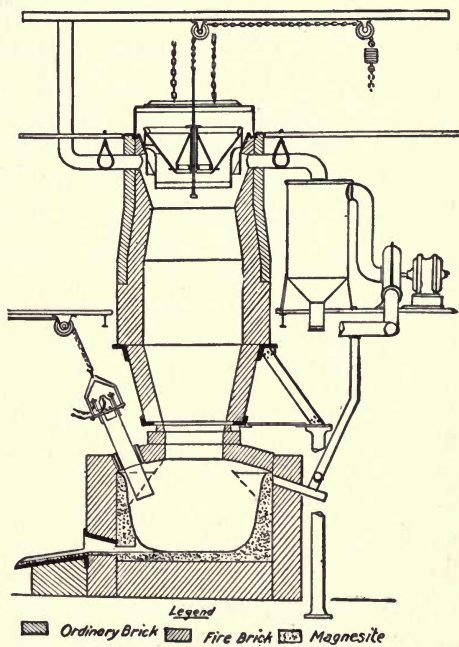

FIG. 103. — Electric furnace at Domnarfvet, Sweden, for reducing iron ore

⁹ Haanel, Trans. Am. Electrochem. Soc. 15, 25, (1909).

high shaft containing the charge to permit the heated carbon monoxide to produce the maximum reduction of the ore. Seven furnaces were constructed and tested before arriving at the one which they considered practical and commercial. This required over two years and an expenditure of \$102,000.¹⁰ A vertical section of the furnace is shown in Figure 103, from which the general construction is perfectly obvious. It evidently resembles somewhat Stassano's original furnace, and, like his, is started as an ordinary blast furnace.¹⁰ The crucible is 2.25 meters in diameter and 1.5 meters high. The most important point in the construction is the manner in which the electrodes are brought into the melting chamber. As seen from the section, they enter through that portion of the roof of the crucible that does not come in contact with the charge, and pass into the charge at the slope formed by the materials of which it is composed. The electrodes dip into the charge, but not into the melted iron beneath it.¹¹ Experiments had shown that the brickwork lining around the electrodes was always destroyed if brought in contact with the charge, even when the electrodes were water cooled. The brickwork composing the lining of the roof of the melting chamber was cooled by forcing against it, through tuyères, the comparatively cool tunnel-head gases. The heat absorbed by these gases is given back to the charge above.

A three-phase current is supplied to three electrodes 11 by 22 inches in cross section and 63 inches in length. The water-cooled stuffing boxes through which the electrodes enter the melting chamber are provided with devices to prevent the hot gases under pressure from leaking out around the electrodes. The results of a short run that was made in the presence of Dr. Haanel showed (1) that the furnace operated uniformly and without trouble of any kind for five consecutive days, the electrodes requiring no adjustment whatever; (2) that the energy consumption was remarkably uniform; (3) that a free

¹⁰ For the evolution of the furnace, and dimensions, see *Met. and Chem. Eng.* **8**, 11, (1910).

¹¹ Assar Grönwall, *Electrochem. and Met. Ind.* **7**, 420, (1909).

space was maintained between the charge and the roof of the heating chamber; (4) that the charge did not jam at the lower contracted neck of the shaft, but moved with regularity into the melting chamber; and (5) that the lining of the roof of the melting chamber was effectively cooled by the circulation of gas.

Since the short run witnessed by Dr. Haanel, the furnace has been in continual operation for 85 days, and met all the requirements that indicate a durable furnace.¹⁰ The designers of this furnace have contracted to erect three large furnaces for the reduction of iron ores at Sault Ste. Marie, Canada, to be in operation by the middle of 1910.¹² The first electric smelting plant in Canada was under construction at Welland, Ontario, in 1907.¹³ It was to consist of a 3000 horse power furnace of the latest type brought out by Héroult.

In 1909 an electrothermic plant for reducing iron ore was in existence on the Pitt River at Héroult, Shasta County, California.¹⁴ From the section of this 1500 kilowatt furnace shown in Figure 104, its resemblance to the furnace at Domnarfvet will be evident. A general view is shown in Figure 105. Though this furnace is on a commercial scale, in July, 1910, it was still in the experimental stage, on account

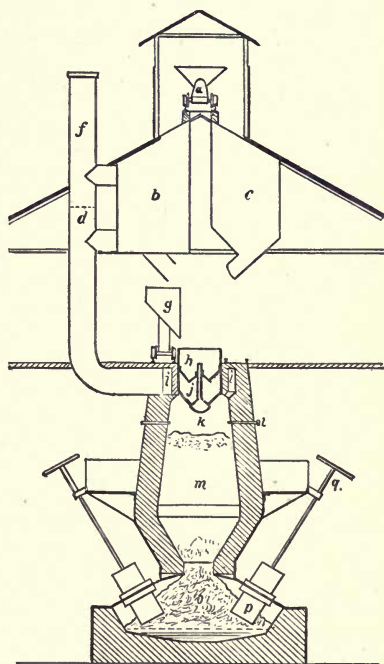

FIG. 104.—Electric furnace at Héroult, California, for reducing iron ore

¹² *Electrochem. and Met. Ind.* 7, 535, (1909).

¹³ Haanel's Report, 1907, p. 147.

¹⁴ D. A. Lyon, *Trans. Am. Electrochem. Soc.* 15, 39, (1909).

of numerous difficulties that had been encountered. Several changes have been made and it is expected that the furnace will be perfected shortly. When this is accomplished, the Noble Electric Steel Company will build four or five others of a similar type.¹⁵ Pig iron on the Pacific coast brings \$23 to \$26 a ton,¹⁶ and the cost from this furnace is expected to be \$15 a ton, which leaves a good margin of profit.

3. THE ELECTROTHERMIC REFINING OF STEEL

While the application of electrothermics to the reduction of pig iron is scarcely an established commercial industry, the case is quite the reverse in steel refining, for a large number of furnaces for this purpose are in operation in Europe and America. Even in this case, however, the electric furnace cannot compete with the Bessemer or with the open-hearth process for making structural steel. Electric furnace refining is used only to produce very high-class steel for special purposes,¹ for which it is far superior to the crucible process, on account of the greater cheapness and higher quality of the steel produced.² The reason for the better quality of the product is that the atmosphere is neutral, and a much higher temperature can be obtained than by other means, resulting in a more complete removal of impurities, especially gases. Phosphorus and sulphur disappear nearly completely, and deoxidation is more complete than that attained by any other means. Another advantage of electric heating is the reliability and certainty of the process.³

A number of different electric furnaces have been designed for refining steel, and some of the principal ones will now be described.

¹⁵ Private communication from Professor D. A. Lyon, the manager of the company.

¹⁶ Bennie, *Trans. Am. Electrochem. Soc.* **15**, 36, (1909).

¹ Haanel's Report, (1904), p. 31; Hibbard, *Trans. Am. Electrochem. Soc.* **15**, 231, (1909).

² Askenasy, *Technische Elektrochemie*, p. 56, (1910).

³ Askenasy, *Technische Elektrochemie*, p. 156, (1910).

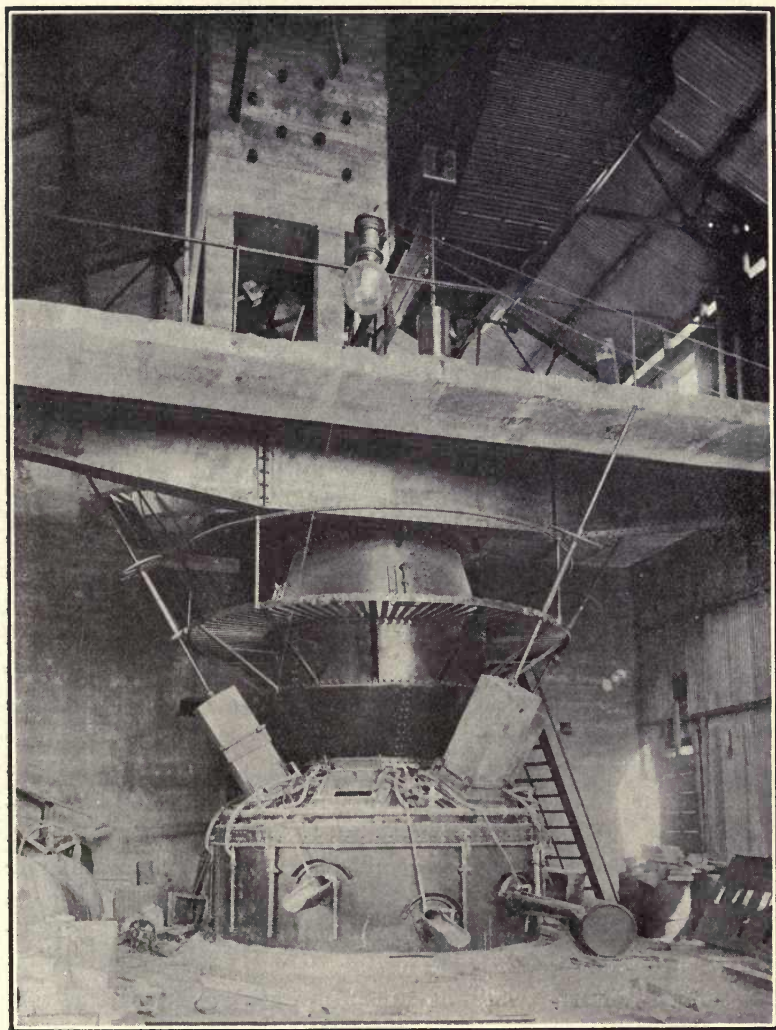

FIG. 105. — Electric furnace at Héroult, California, for reducing iron ore

The furnace used by Stassano at his works in Turin is similar to the one he finally adopted for reducing iron ore⁴ (Figures 99 and 100). The charge is heated by radiation from arcs formed between three electrodes placed above the charge and supplied with a three-phase current. This furnace also rotates on an axis slightly inclined to the vertical, in order to mix the charge thoroughly. The lining is magnesite brick.⁵ Starting with scrap and oxidized turnings, about one kilowatt hour is required for one kilogram of finished steel in the 250 horse power furnaces used at Turin.

A furnace designed by Charles Albert Keller for steel refining, which was put into industrial use in 1907, is shown in Figures 106 and 107. It consists of a crucible with a conducting bottom for one electrode and a vertical carbon rod for the other.⁶ Since carbon must not be brought in contact with the melted iron in refining, the bottom must be made conducting without the use of carbon, and this was accomplished by Keller as follows: Iron bars from 1 to $1\frac{1}{4}$ inches in diameter are regularly spaced about one inch apart, and are made fast to a metallic plate at the bottom, covering the entire area on which the bath will rest. Agglomerated magnesia is then rammed, while hot, in between the bars. The whole base is surrounded by a metallic casing for water cooling. Electrical contact is made by the lower plate to which the bars are fastened. The furnace is closed by a cover through which the other electrode passes. After several months' use a hearth constructed in this manner was found to be in as good condition as on the first day. The advantage claimed for this arrangement over a furnace with two vertical electrodes is that the current is more evenly distributed through the charge, and consequently heats it more evenly. Of course, the iron bars are melted at their upper ends where they come in contact with the melted iron to be refined, but the water cooling prevents them from melting for more than a few inches of their length.

⁴ Trans. Am. Electrochem. Soc. 15, 63, (1909).

⁵ Trans. Am. Electrochem. Soc. 15, 86, (1909).

⁶ Trans. Am. Electrochem. Soc. 15, 96, (1909).

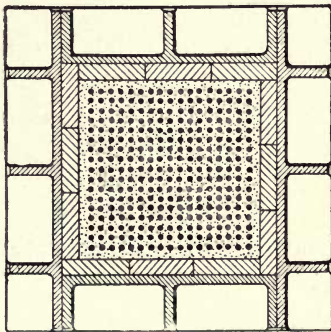
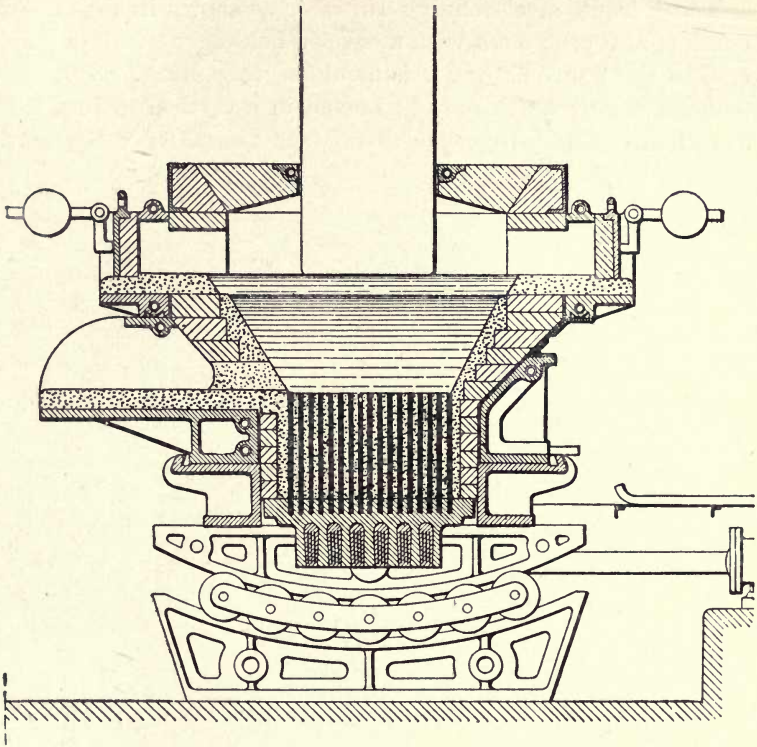

FIGS. 106 and 107. — Keller conducting hearth furnace

The Héroult steel refining furnace,⁷ as shown in Figure 108, consists of a crucible *a* with a cover *b* holding a small chimney *c*. As the figure shows, it is arranged for tilting. *d* are carbon electrodes, which may be moved in a vertical or in a horizontal direction. In order to use the furnace for Bessemer-

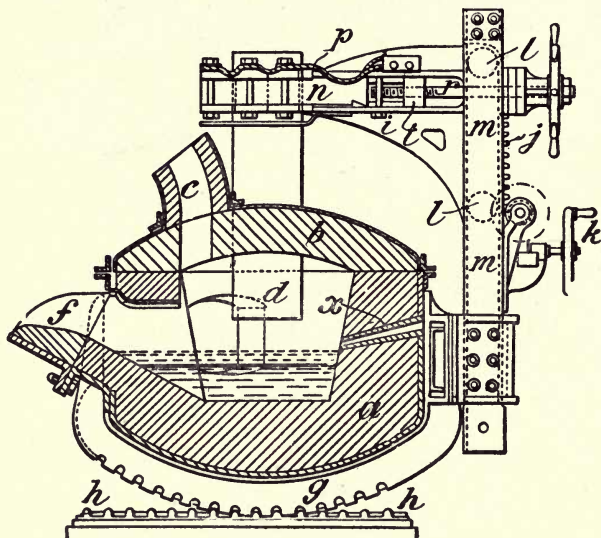

FIG. 108. — The Héroult electric steel furnace

izing, the tuyères *x* are provided. The two electrodes do not quite touch the slag on the surface, so that two arcs are produced. In passing through the bath, the current, of course, divides between the slag and the melted iron in proportion to their conductivities, and as melted iron conducts better than the slag, a larger proportion would flow through the metal than through the slag. The poorest kinds of scrap, high in sulphur and phosphorus, are refined in this furnace. The following table shows the average refining ability of a 2½-ton furnace at La Praz, Savoy :

⁷ Electrochem. Ind. 1, 64, (1902) ; U. S. Pat. 707,776.

TABLE 31

	PER CENT				
	Sulphur	Phosphorus	Manganese	Silicon	Carbon
Scrap charged	0.052	0.150	0.638	0.062	0.211
Finished steel	0.006	0.009	0.254	0.172	1.013

For a 5-ton furnace, starting with cold scrap, 600 kilowatt hours are necessary to partially refine one long ton of steel, and 100 more for the finishing slag. For a 15-ton furnace, less power would be required.

Figure 109 shows a 15-ton three-phase Héroult furnace at the South Chicago Works of the Illinois Steel Company. The steel to be treated is brought directly from the Bessemer converters, and two refining slags are used in the electric furnace, the first an oxidizing slag to take out the phosphorus, and the second, a deoxidizing slag for removing the sulphur and the gases.⁸ Power is supplied to the three electrodes by three transformers, each of 750 kilowatts capacity. Two hundred and forty tons of steel are turned out per day in 16 heats. The electrodes, 2 feet in diameter and 10 feet in length, are the largest ever made in one piece. In cold melting and in continuous work, the consumption of electrode is from 60 to 65 pounds per ton of steel, but when the metal is charged in the melted state, the consumption would be reduced to 10 or 15 pounds per ton of steel. This includes the short ends that cannot be utilized. The linings last from three months to one year, depending on the care with which the furnace is run; the roof suffers most, and generally has to be renewed once a month. The best lining for this furnace is magnesite mixed with basic slag, with tar for a binder.

The Paul Girod electric furnace⁹ is somewhat similar to the Keller furnace, as seen from Figure 110. One or more elec-

⁸ Robert Turnbull, *Trans. Am. Electrochem. Soc.* **15**, 139, (1909).

⁹ Paul Girod, *Trans. Am. Electrochem. Soc.* **15**, 127, (1909).

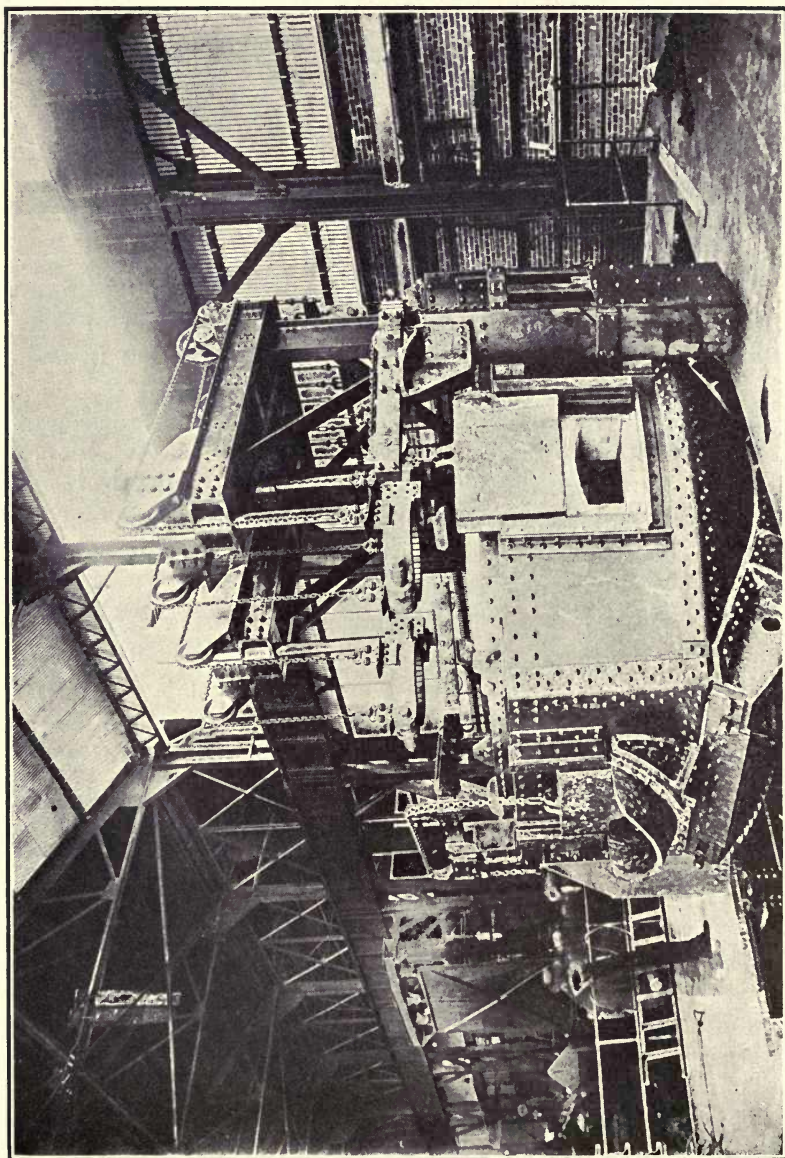

Fig. 109. — Three-phase 15-ton Héroult furnace at South Chicago

trodes of like polarity are suspended above the crucible, while the electrode of opposite polarity consists of a number of pieces of soft steel buried in the refractory material of the hearth at its periphery and water cooled at their lower ends. The upper ends come in contact with the bath and are melted to a depth of 2 to 4 inches. About 55 volts are applied to this furnace. For fusing, refining, and finishing a charge of cold scrap in a 2-ton furnace, about 900 kilowatt hours per metric ton of steel are required, and in an 8 to 10 ton furnace, 700 kilowatt hours. The electrode consumption is 16 to 18 kilograms per metric ton of steel produced in a 2-ton furnace, and 13 to 15 kilograms in an 8 to 10 ton furnace. The short ends are included as having been used. The lining is magnesite or dolomite brick or paste, and lasts 40 to 50 heats without any repairs whatever.

An entirely different class of steel-refining furnaces are those having the melted metal in the form of a ring, forming the secondary of a transformer which is heated by an induced current from a primary coil of copper wire. This type of furnace was patented in 1887 by Colby in the United States and by Ferranti in England.

The same principle was applied on a small scale in 1900 by F. A. Kjellin at Gysinge, Sweden, without knowing at the time that it had been patented by others.¹⁰ Kjellin,

¹⁰ Kjellin, *Trans. Am. Electrochem. Soc.* 15, 173, (1909).

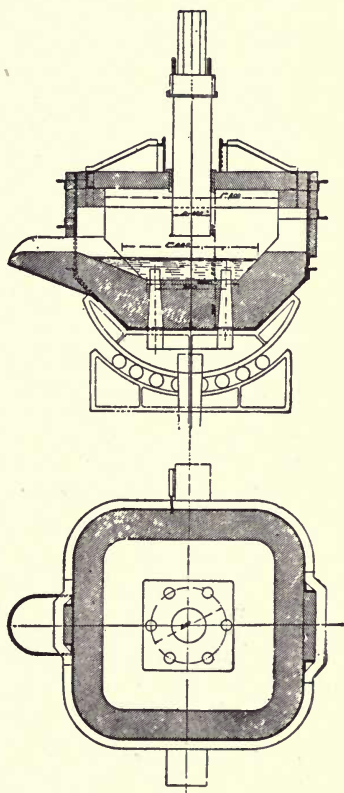
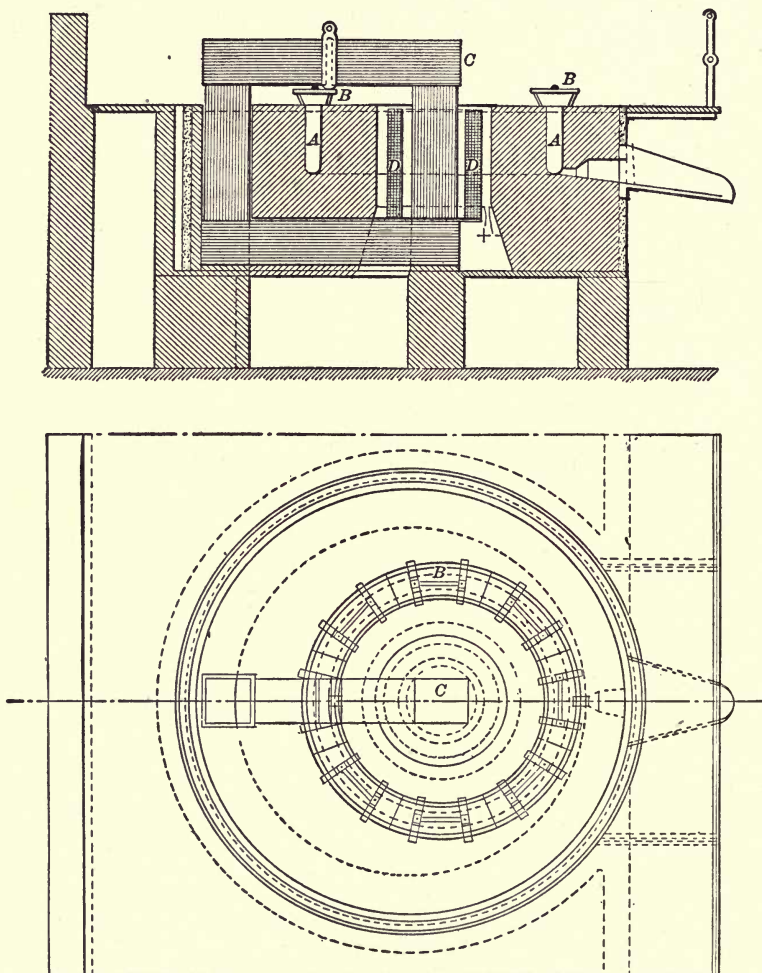

FIG. 110. — The Girod electric steel furnace

however, seems to have been the first to carry this idea out on a commercial scale. In 1902 a 225 horse power induction furnace was in operation at Gysinge, with an output of 4 metric tons in 24 hours. This furnace had a magnesite lining in



FIGS. 111 and 112. — Elevation and plan of the Kjellin induction furnace

place of silica used in the smaller furnace. A silica lining lasted only about one week, while the magnesite lasted twelve.

Figures 111 and 112 show the principle of the Kjellin furnace. The magnetic circuit *C* is built up of laminated sheet iron. *D* is the primary circuit, consisting of a number of turns of insulated copper wire or tubing. The ring-shaped crucible *A*, for holding the melted metal, is made of refractory material. This furnace cannot be started by placing cold scrap in the crucible because of the low induced electromotive force, but an iron ring must be placed in the crucible and melted down, or the crucible must be filled with melted metal taken from another source. The power consumption of the furnace at Gysinge, starting with cold pig iron and scrap, is about 800 kilowatt hours per metric ton of product. This furnace has been found very satisfactory for making the highest-class steel from pure raw materials.

There is a limit to the current that can be sent through the liquid metal, and consequently a limit to the temperature attainable. This is due to a phenomenon first observed by Paul Bary in 1903,¹¹ to which the name "pinch effect" was given by Hering.¹² This phenomenon is as follows: When a direct or an alternating current passes through a liquid conductor, the conductor tends to contract in cross section, forming a depression, and if the current is large enough, the metal in the trough will separate entirely and break the circuit. This is due, of course, to the attraction the different elements of the current exert on each other. It is most likely to happen at some particular place where the cross section of the ring is smaller than elsewhere, and if any infusible material falls into this depression, it may prevent the reunion of the liquid and cause the charge to freeze. The largest possible current that could be passed through liquid iron in a trough 2 inches deep and 1 inch wide is about 3300 amperes; in a trough 4 by 2 inches, 9400 amperes; and in a trough 6 by 3 inches, 17,000 amperes.¹³ Larger currents would cause the metal to separate

¹¹ Northrup, *Trans. Am. Electrochem. Soc.* **15**, 303, (1909).

¹² Hering, *Trans. Am. Electrochem. Soc.* **11**, 329, (1907); **15**, 255 and 271, (1909).

¹³ *Trans. Am. Electrochem. Soc.* **15**, 269, (1909).

entirely. When a depression is formed, hydrostatic pressure balances the pressure due to the current, so that this effect is not so likely to give trouble in a deep channel as in a shallow one, nor with a heavy metal as with a light one. It has been found impossible, for instance, to raise aluminum much above its melting point, in a 60 kilowatt induction furnace on account of this effect.¹⁴

The Kjellin furnace is not adapted to working with dephosphorizing and desulphurizing slags, as the annular ring is not a convenient shape and offers too small a surface to the attack of the slag.¹⁵ A combined induction and resistance furnace was therefore invented by Rodenhauser, known as the Röchling-Rodenhauser furnace for refining Bessemer steel. A plan and an elevation of this furnace are shown in Figures 113 and 114. *HH* are the two legs of the iron transformer core, surrounded by the primary windings *AA*. Surrounding the legs of the transformer are the two closed circuits of melted metal, forming together a figure 8, in which currents are induced. *BB* are two extra primary coils, from which the current is conducted to the metallic plates *EE*. These are covered by an electrically conducting refractory material, through which the current passes into the main hearth, *D*. The result is that the main hearth can be made with a much larger cross section than the ring in the original Kjellin furnace, and a good power factor can be obtained in large furnaces without such a low periodicity as was necessary with the original induction furnaces. The magnitude of the current from the secondary coils is limited by the carrying capacity of the refractory material *G*, which would be destroyed if too heavily loaded. In refining, the furnace is worked as follows: Fluid steel from the converters is poured into the furnace, and burnt limestone and mill scale are added for forming a basic dephosphorizing slag. This is removed, after the reactions are ended, by tilting the furnace. For making rails the phosphorus is reduced sufficiently in one operation, but for the highest-class steel it has to be repeated.

¹⁴ FitzGerald, Trans. Am. Electrochem. Soc. 15, 278, (1909).

¹⁵ Kjellin, Trans. Am. Electrochem. Soc. 15, 175, (1909).

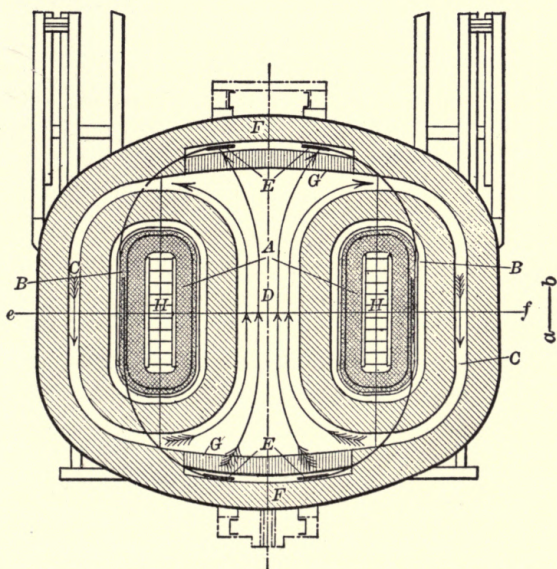
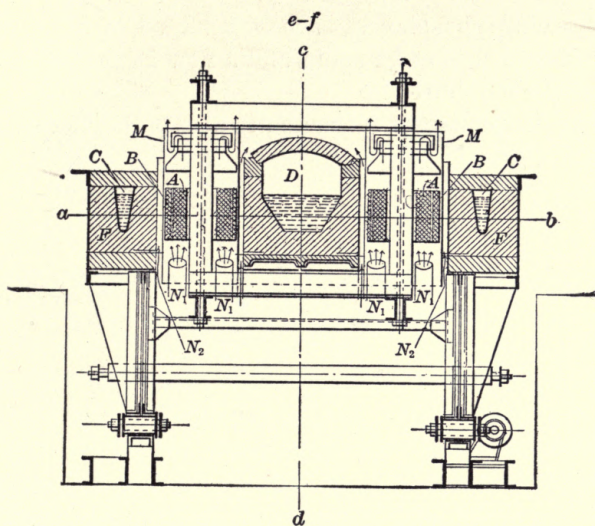

FIGS. 113 and 114. — Elevation and plan of the Röchling-Rodenhauser furnace

After removing phosphorus, carbon is added in the pure state when carbon steel is to be made, and a new basic slag is formed to remove the sulphur.

Röchling-Rodenhauser furnaces are also built for three-phase currents.

CHAPTER XIV

THE FIXATION OF ATMOSPHERIC NITROGEN

I. INTRODUCTION

NITROGEN, though chemically an inert element, is of great importance to plant and animal life. It forms 80 per cent by volume of the atmosphere, but it has been impossible until recently to get atmospheric nitrogen in a combined state for use in fertilization or in the chemical industries. This was a problem of the greatest importance, as the nitrogen removed from the soil by crops must be replaced either by adding it in the form of some nitrogen compound or by raising a crop, such as clover, that assimilates the nitrogen of the air by means of a certain kind of bacteroid existing on the root of the plant. Consequently, Chili saltpeter is used in large quantities for fertilization, but as this supply is not expected to last later than 1940,¹ the discovery of some other means of supplying the demand became imperative.

At present there are three different methods in operation of combining atmospheric nitrogen. The first method consists in heating calcium carbide in pure dry nitrogen to about 1000° C., whereby nitrogen is absorbed, forming calcium cyanamide, according to the reversible reaction:

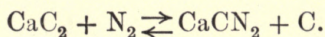

The second method consists in oxidizing nitrogen to nitric oxide in the electric arc and absorbing the oxide in water or in an alkaline solution, and the third and most recent method is the direct synthesis of ammonia from its elements.

¹ Edström, Trans. Am. Electrochem. Soc. 6, 17, (1904).

2. ABSORPTION BY CALCIUM CARBIDE

According to Moissan, pure carbide is unaffected by nitrogen at 1200° C.¹ The discovery that nitrogen is absorbed by commercial calcium carbide and barium carbide was patented in 1895 by Adolph Frank and N. Caro.² In the case of barium carbide 30 per cent forms cyanide in place of cyanamide,³ while in the case of calcium only a trace of cyanide is formed.

Since 1895 this reaction has been the subject of a number of investigations. With regard to the temperature required, it has been shown that finely powdered carbide must be heated to from 1000° to 1100° C. to bring about complete transformation to cyanide. At 800° to 900° some nitrogen is absorbed, but the reaction ceases before all the carbide is used up.⁴ By the addition of other calcium salts, such as calcium chloride, or, to a less extent, calcium fluoride, complete nitrification can be produced at 700° to 800° C.⁵ That the commercial carbide can be completely nitrified at 1100° is due to the presence of calcium oxide.⁶ Commercial calcium carbide containing 75 to 80 per cent carbide can be made to take up 85 to 90 per cent of the theoretical amount of nitrogen, forming a black mass of calcium cyanamide, lime, and carbon containing 20 to 23.5 per cent of nitrogen.³ Pure calcium cyanamide contains 35 per cent nitrogen. The reaction by which it is made is accompanied by a large evolution of heat, which of course is advantageous in its manufacture. According to Caro, this heat is sufficient to cause the reaction to proceed of itself when once started.⁷

The system consisting of calcium carbide, calcium cyanamide, carbon, and nitrogen, is monovariant, that is, for every temperature there is a corresponding pressure of the nitrogen at which equilibrium exists. This equilibrium has been meas-

¹ C. R. **118**, 501, (1894).

² Frank, Z. f. angew. Ch. **19**, 835, (1906).

³ Erlwein, Z. f. angew. Ch. p. 533, (1903).

⁴ Foerster and Jacoby, Z. f. Elektroch. **15**, 820, (1909).

⁵ Bredig, Z. f. Elektroch. **13**, 69, (1907).

⁶ Foerster and Jacoby, Z. f. Elektroch. **13**, 101, (1907).

⁷ N. Caro, Z. f. angew. Ch. **22**, 1178, (1909).

ured between 1050° C. and 1450° C., and the results are given in the plot in Figure 115.⁸ If the initial pressure of nitrogen lies in the region above the line, absorption of nitrogen takes place, while if below, any calcium cyanamide present would

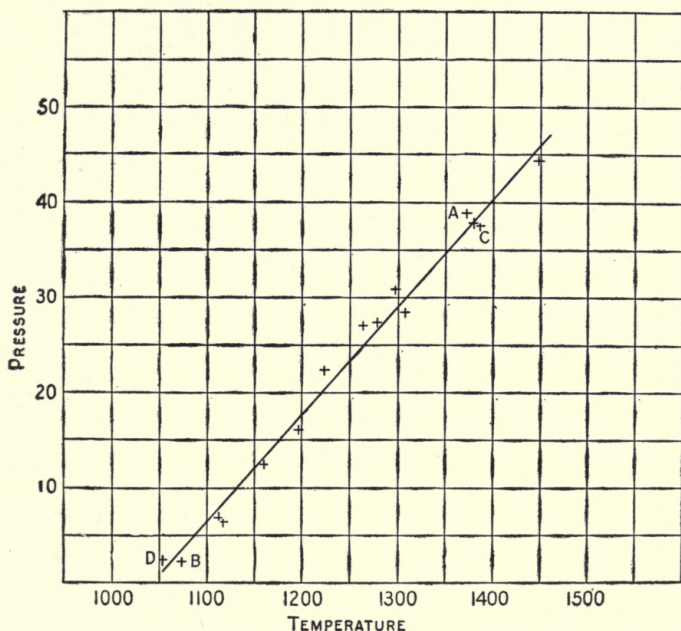

FIG. 115.—Plot showing pressures and temperatures at which equilibrium of the reaction $\text{CaC}_2 + \text{N}_2 \rightleftharpoons \text{CaCN}_2 + \text{C}$ exists. Pressures are in centimeters of mercury; temperatures in centigrade degrees.

decompose until the nitrogen produced brings the pressure up to that corresponding to equilibrium, or until all of the cyanamide is used up.

The velocity of absorption of nitrogen is proportional to its pressure,⁹ assuming other conditions constant. At a constant

⁸ Thompson and Lombard, Proc. Am. Acad. **46**, 247, (1910); Met. and Chem. Eng. **8**, 617, (1910). During proof reading the experiments of Le Blanc and Eschmann, with results different from those above, appeared; see Z. f. Elektroch. **17**, 20, (1911). They find that the pressure depends on the nitrogen content of the solid phase as well as on the temperature.

⁹ Bredig, Fraenkel, and Wilke, Z. f. Elektroch. **13**, 605, (1907).

temperature, with a constant surface of carbide exposed, and a given amount of nitrogen in a given volume, this law is expressed by the differential equation:

$$-\frac{dp}{dt} = kp,$$

where p is the pressure, t the temperature, and k is a constant. Integrated this becomes

$$k = \frac{1}{0.43 t} \log \frac{p_2}{p_1},$$

where p_2 and p_1 are the pressures at the beginning and end respectively of the time interval t .

Calcium cyanamide acts in some cases as the calcium salt of cyanamide: $\text{Ca} = \text{N} - \text{C} \equiv \text{N}$, and in others as the calcium salt of the diimide

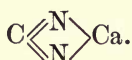

With superheated steam the nitrogen is changed to ammonia according to the reaction²

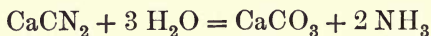

with a yield 99 per cent.¹⁰ Dicyandiamid, a compound containing 66 per cent nitrogen, can be made by treating calcium cyanamide with water. It has the appearance of ammonium chloride, and is probably formed by the following reaction:

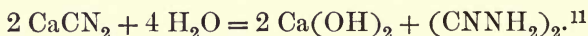

Calcium cyanide can be made from technical calcium cyanamide by melting with a suitable flux, such as sodium chloride, according to the following reversible reaction:

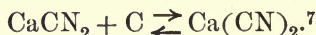

This use of calcium cyanamide is second in importance only to its direct application as a fertilizer.²

According to Frank² one horse power year can produce enough carbide to absorb 772 kilograms of nitrogen, though the value actually realized amounts to only 300 to 330 kilo-

¹⁰ Erlwein, Z. f. Elektroch. 12, 551, (1906).

¹¹ Z. f. angew. Ch. p. 520, (1903).

grams. According to a later statement by Caro,⁷ 3 horse power years is more than sufficient to absorb one metric ton of nitrogen, including the manufacture of the carbide and all the other power required in the factory for the grinding and moving apparatus, the Linde machines for liquefying air, and so forth. Thus a factory with 12,000 horse power produces yearly 20,000 metric tons of calcium cyanamide containing 20 per cent nitrogen, corresponding to 4000 metric tons of nitrogen. It is interesting to compare these data with the power required to produce the corresponding amount of calcium carbide. An average yield of carbide has been shown above to be 5.5 kilos of 80 per cent carbide per kilowatt day, corresponding to 1500 kilos per horse power year. 376 kilograms of nitrogen would have to be absorbed by this amount of carbide in order that the product should contain 20 per cent nitrogen. This is a little above the value 300 to 330 actually obtained as given by Frank. If the statement of Caro is correct, and carbide is produced with the efficiency assumed above, it means that 90 per cent of the power in a cyanamide factory is used for producing the carbide alone.

Nitrogen is obtained by the Linde process or by removing the oxygen with hot copper. It must be free from oxygen, for this would produce carbon monoxide, which decomposes both carbide and cyanamide.⁷ Caro states that moisture must be also absent, though Bredig, Fraenkel, and Wilke's⁹ experiments showed that when the nitrogen was saturated with water vapor at 22°, a little more nitrogen was absorbed than when dry.

Besides lime and carbon, there are impurities in technical cyanamide, consisting of nitrogen compounds, such as urea, guanidine, and calcium carbamate. In fresh samples these impurities are small in quantity, but increase on standing or by the presence of water vapor. All of these substances are easily assimilated by plants.⁷

The manufacture of calcium cyanamide was begun on a large scale in 1905 at Piano d'Orta, Italy,¹⁰ and in 1908 there were 11 factories in Europe making this substance.¹² Norway and

¹² Min. Ind. 17, 105, (1908).

Sweden are unusually favorable localities for the nitrogen industry on account of the large amount of cheap water power. Recent estimates on power in these countries are as follows: ¹³

	AVAILABLE	DEVELOPED
Sweden	4,000,000 h. p.	400,000 h. p.
Norway	5,000,000 h. p.	500,000 h. p.

The figures under "developed" refer to plants in operation or under construction. There is a 20,000 horse power plant for the production of cyanamide and calcium carbide at Odda, Norway, having a capacity of 32,000 short tons of carbide and 12,500 tons of cyanamide per year. The nitrogen, which must not contain over 0.4 per cent oxygen, is obtained by the Linde process. The furnaces in which the carbide is heated with nitrogen are charged with about 700 pounds and produce 2000 pounds of cyanamide containing 20 per cent nitrogen per week. In 1909 this industry was introduced on this side of the Atlantic by the American Cyanamide Company, which owns the exclusive rights for manufacturing *nitrolime* in this country. A factory is now in operation at Niagara Falls, Ontario.¹⁴ The product is to contain 12 to 15 per cent nitrogen, 10 per cent carbon, and 25 per cent calcium sulphate. Free lime is to be eliminated as is demanded by American trade.

3. THE OXIDATION OF NITROGEN

Priestley¹ was the first to observe that electric sparks in air produced an acid, though he mistook it for carbonic acid. Later Cavendish² repeated the experiments and showed the true nature of the acid produced, which is now known to be a mixture of nitrous and nitric acids. From the time of Caven-

¹³ *Electrochem. and Met. Ind.* **7**, 212 and 360, (1909).

¹⁴ *Met. and Chem. Eng.* **8**, 227, (1910).

¹ *Experiments and Observations on Different Kinds of Air*, **4**, 286. Preface dated 1779. Also Ostwald, *Elektrochemie*, p. 11.

² *Phil. Trans.* **75**, 372-384, (1797). Also *Alembic Club Reprints*, No. 3, p. 39.

dish until within the last twenty years nothing of importance was done toward explaining this phenomenon. Since 1890, however, it has received considerable attention, so that now, principally due to the work of Nernst and Haber, the conditions under which the reaction $N_2 + O_2 \rightleftharpoons 2 NO$ takes place are well known.

Nernst and his assistants have measured the thermal equilibrium concentrations of nitrogen, oxygen, and nitric oxide at different temperatures with the results in Table 32.³

TABLE 32

Per cent by Volume of Nitric Oxide in the Equilibrium Mixture formed from Air

DEGREES ABSOLUTE	PER CENT NO		OBSERVER
	Observed	Computed	
1811	0.37	0.35	Nernst
1877	0.42	0.43	Jellinek
2023	0.52 to 0.80	0.64	Jellinek
2033	0.64	0.67	Nernst
2195	0.97	0.98	Nernst
2580	2.05	2.02	Nernst-Finckh
2675	2.23	2.35	Nernst-Finckh

The values in the third column were computed by the Van't Hoff equation, with Berthelot's value of $-21,600$ calories for the heat of the reaction. These experiments show that at the temperatures given the velocity of decomposition is so low that the gas can be cooled without decomposition of the nitric oxide already formed.

The free energy of the reaction is given by the equation⁴

$$\Delta F = Q - RT \log \frac{p_{NO}}{p_{N_2}^{\frac{1}{2}} \cdot p_{O_2}^{\frac{1}{2}}} + 2.45 T,$$

in which $Q = -21,600$ calories. By means of this equation the per cent of nitric oxide corresponding to the equilibrium at any temperature can be computed by placing the right-hand

³ Z. f. anorg. Ch. 49, 213, (1906).

⁴ Haber, Thermodynamics of Technical Gas Reactions, p. 105, (1908).

side equal to zero, which is the equilibrium condition. The experiments of Finckh were carried out by exploding air mixed with detonating gas; the others by drawing air through platinum or iridium tubes heated electrically. The good agreement between the calculated and observed values shows that at least in these experiments the nitric oxide formed is due only to the high temperature, as the concentration is that required by thermodynamics.

This reaction is bimolecular between 650°C . and 1750°C .,⁵ that is to say, it should be written $\text{N}_2 + \text{O}_2 = 2\text{NO}$. Le Blanc and Nüranen, however, have found that above 3000°C . the reaction is monomolecular.⁶ Tables 33 and 34 give the velocities of the reaction in both directions at different temperatures.⁶

TABLE 33

Time in Minutes necessary to decompose Pure Nitric Oxide at Atmospheric Pressure, Half into Nitrogen and Oxygen

DEGREES ABSOLUTE	TIME IN MINUTES	DEGREES ABSOLUTE	TIME IN MINUTES
900	7.35 10^3	2100	1.21 10^{-3}
1100	5.80 10^2	2300	8.40 10^{-5}
1300	4.43 10^1	2500	5.76 10^{-6}
1500	3.30	2700	3.92 10^{-7}
1700	2.47 10^{-1}	2900	3.35 10^{-8}
1900	1.47 10^{-2}	3100	2.25 10^{-9}

TABLE 34

Time required to produce from Air One Half the Possible Amount of Nitric Oxide

DEGREES ABSOLUTE	TIME IN MINUTES	DEGREES ABSOLUTE	TIME IN MINUTES
1500	1.81 10^3	2500	1.77 10^{-4}
1700	5.90 10^1	2700	8.75 10^{-6}
1900	2.08	2900	5.75 10^{-7}
2100	8.43 10^{-2}	3100	3.10 10^{-8}
2300	3.75 10^{-3}		

⁵ Jellinek, Z. f. anorg. Ch. **49**, 229, (1906).

⁶ Z. f. Elektroch. **13**, 303, (1907).

From these results it would appear that the best yield of nitric oxide would be obtained by heating the gas to the highest temperature from which it could be chilled so suddenly that decomposition would not take place. It has been shown, however, that nitric oxide can be produced by the silent discharge of electricity where there is very little elevation of temperature.⁷ This fact suggested to Haber and Koenig⁸ the possibility of obtaining better yields by using a comparatively cool arc, which could be realized by inclosing it in a tube surrounded by water. Below 3000° C. any oxide produced by the impact of electrons would not be decomposed rapidly by the heat even if the concentration due to the electrical effect were greater than that due to the thermal. In fact they found that by using a cooled arc and by reducing the pressure to the most favorable value of 100 millimeters, concentrations of nitric oxide were obtained which could be explained thermally only on the assumption that the thermal equilibrium corresponding to over 4000° absolute had been obtained and that the gas had been chilled suddenly enough to preserve it. Such a high

TABLE 35

Concentrations of Nitric Oxide obtained at 100 mm. Pressure by an Arc inclosed in a Cooled Tube

INITIAL GAS MIXTURE IN PER CENT BY VOL.		$K = \frac{p_{\text{NO}}}{p^{\frac{1}{2}}\text{O}_2 \cdot p^{\frac{1}{2}}\text{N}_2}$	NO CONTENT IN PER CENT BY VOL.	THERMODYNAMICALLY COMPUTED TEMP. ABS.	
O ₂	N ₂			Haber	Nernst
20.9	79.1	0.284	9.8	4365	4334
48.9	51.1	0.337	14.4	4686	4650
44.4	55.6	0.337	14.3	4686	4650
75.0	25.0	0.357	12.77	4805	4767
81.7	18.3	0.397	12.1	5042	5000

⁷ Warburg and Leithäuser, Ann. d. Phys. (4) 20, 743, (1906), and 23, 209, (1907).

⁸ Z. f. Elektroch. 13, 725, (1907).

temperature in their arc seemed impossible; consequently the oxide must have been produced directly by the impact of ions. Table 35 gives the concentrations of nitric oxide obtained with the temperature corresponding, on the improbable assumption that this concentration corresponds to a thermal and not to an electrical equilibrium. The temperatures were computed both by Haber's formula given above and by the Van't Hoff formula as used by Nernst.

In later experiments as high as 17.8 per cent nitric oxide was obtained.⁹ It was further found that the same concentration is obtained under similar conditions from either nitric oxide or from air and oxygen, showing that we have in this case an electrical equilibrium. If the temperature is too high, the electrical equilibrium is obliterated by the thermal. On the other hand, the electrical energy necessary to produce ionization increases considerably when the temperature falls below white heat. There will therefore be a most favorable region of temperature within which the nitric oxide produced by the impact of ions will not be decomposed and when too much electrical energy is not required for ionization.⁸ It would, therefore, seem that the best way to try to obtain better results is to employ a cool arc rather than by attempting to heat to a higher temperature and chill more suddenly.

The energy efficiency was not determined in these experiments. In later ones,¹⁰ with a cooled arc, the efficiency, when the concentration of the nitric acid obtained was 3.4 per cent, was 57 grams of nitric acid per kilowatt hour, or 500 kilograms per kilowatt year of 365×24 hours. With a cooled arc and a direct current, Holweg and Koenig¹¹ obtained nitric acid at a concentration of 2.5 per cent and an efficiency corresponding to 80 grams of nitric acid per kilowatt hour, the most favorable energy efficiency ever reached. Increasing the pressure above atmospheric does not increase this efficiency.¹²

⁹ Z. f. Elektroch. **14**, 689, (1908).

¹⁰ Z. f. Elektroch. **16**, 795, (1910).

¹¹ Z. f. Elektroch. **16**, 809, (1910).

¹² Haber and Holweg, Z. f. Elektroch. **16**, 810, (1910).

On cooling down, the colorless nitric oxide changes to the brown dioxide of nitrogen, since the reversible reaction

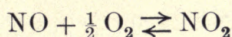

is displaced from left to right on cooling.

Table 36 shows how the dissociation of nitrogen dioxide is affected by the temperature: ¹³

TABLE 36

DEGREES CENTIGRADE	PRESSURE IN CENTIMETERS	PER CENT OF NO ₂ DECOMPOSED
130	71.85	
184	75.46	5.0
279	73.72	13.0
494	74.25	56.5
620	76.00	100.0

It will be interesting to compute from a purely thermal standpoint the energy necessary to produce nitric acid and to compare this result with those actually found by different experimenters. Assuming the temperature of the high tension arc to be 4200° C., the calculation is as follows.¹⁴ From the equation given above at this temperature

$$\frac{p_{\text{NO}}}{p_{\text{O}_2}^{\frac{1}{2}} \cdot p_{\text{N}_2}^{\frac{1}{2}}} = 0.29,$$

and if the original mixture is air, the final composition is:

NO	O ₂	N ₂
10 per cent	16 per cent	74 per cent

Ten moles of nitric oxide with air and water yield 630 grams of nitric acid. Therefore, in order to get this amount of acid, 100 moles must be heated to 4200° C., besides which 10 × 21,600 calories must be supplied for the reaction. Assuming the spe-

¹³ Nernst, *Theoretische Chemie*, p. 455, 6th ed. See also Bodenstein and Katayama, *Z. f. Elektroch.* **15**, 244, (1909).

¹⁴ Haber, *Thermodynamics of Technical Gas Reactions*, p. 268.

cific heat of the permanent gases to be $6.8 + 0.0006$ calories per mole, the total energy will be :

$100 (6.8 + 0.0006 \times 4200) 4200 + 216,000 = 4,130,000$ calories.

This corresponds to 4.71 kilowatt hours for 630 grams of nitric acid, or 134 grams per kilowatt hour. If the arc were 1000° lower, the result would be 93.5 grams per kilowatt hour.

The results obtained with a cooled arc are not due to thermal equilibrium, and of course have no relation to this calculation. Unless special precautions were taken to use a cooled arc, the results may be assumed to be due to thermal and not to electrical causes. This is the case in the following examples.

Lord Rayleigh¹⁵ obtained an absorption of 21 liters an hour with 0.8 kilowatt, using a mixture of 9 parts of air and 11 of oxygen. This corresponds to 46 grams of pure nitric acid per kilowatt hour, assuming the gas was measured at 20° C. and at atmospheric pressure. McDougall and Howles¹⁶ with an arrangement similar to that of Lord Rayleigh obtained 33.5 grams of nitric acid per kilowatt hour. McDougall and Howles were the first to make a small experimental plant for the production of nitric acid from the air.¹⁷ It seems not to have got beyond the experimental stage, however.

The first¹⁸ attempt to carry out the oxidation of nitrogen on a commercial scale was that of the Atmospheric Products Company at Niagara Falls, using the patents of Bradley and Lovejoy. Their first apparatus¹⁹ was similar to that of McDougall and Howles and consisted in a number of small compartments in which an arc was formed between electrodes in the form of a hook at the points nearest together, as shown in Figure 116. The arc then ran along the electrodes, thereby becoming longer, until it went out, whereupon the arc was formed again. This

¹⁵ Journ. Chem. Soc. 71, 181, (1897).

¹⁶ Memoirs and Proceedings of the Manchester Literary and Phil. Soc. (IV) 44, 1900, No. 13.

¹⁷ Huber, Zur Stickstoff Frage, p. 41, Bern, (1908).

¹⁸ Donath and Frenzel, Die Technische Ausmetzung des Atmosphärischen Stickstoffes, p. 126, (1907).

¹⁹ U. S. Pat. 709,867, (1902).

arrangement was supplanted by a single apparatus, shown in Figures 117 and 118, in which 6900 arcs were formed per second.²⁰ This consisted in an iron cylinder 5 feet high, 4 feet in diameter, in the center of which was a rotating shaft carrying a series of radial arms, the ends of which were tipped with

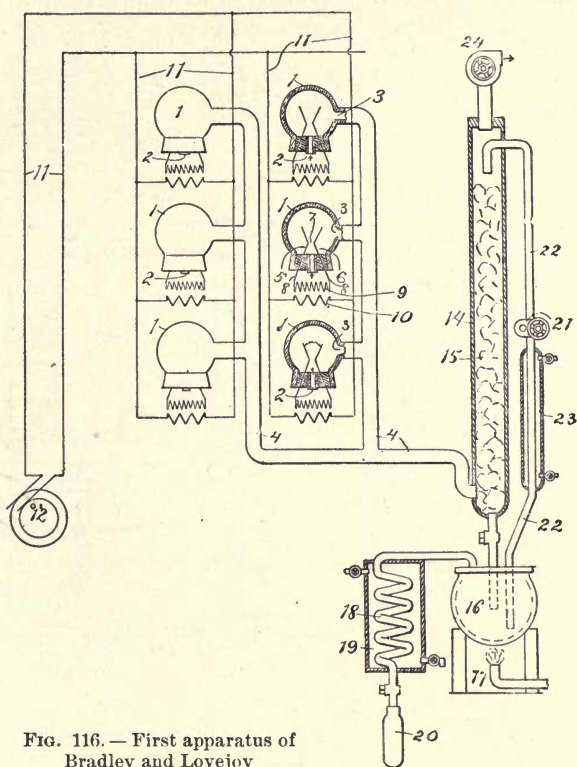

FIG. 116. — First apparatus of Bradley and Lovejoy

platinum. Six rows of 23 inlet wires projected through the cylinder and terminated in a platinum hook. As the radial arms rotated, their platinum tips passed the hooks on the inlet wires, coming within one millimeter of touching at the nearest point. An arc was formed which was drawn out from 4 to 6 inches before going out. The arms were so arranged that the

²⁰ J. W. Richards, *Electroch. Ind.* 1, 20, (1902); U. S. Pat. 709,868, (1902).

arcs between them and the inlet wires were formed successively rather than simultaneously. The central shaft made 500 rotations per minute. Each inlet wire had in series with it an induction coil 12 inches long and 5 inches in diameter, wound with very fine wire and immersed in oil. The self-induction of the coil caused the spark to be drawn out to a greater length than would be possible without induction. A direct current

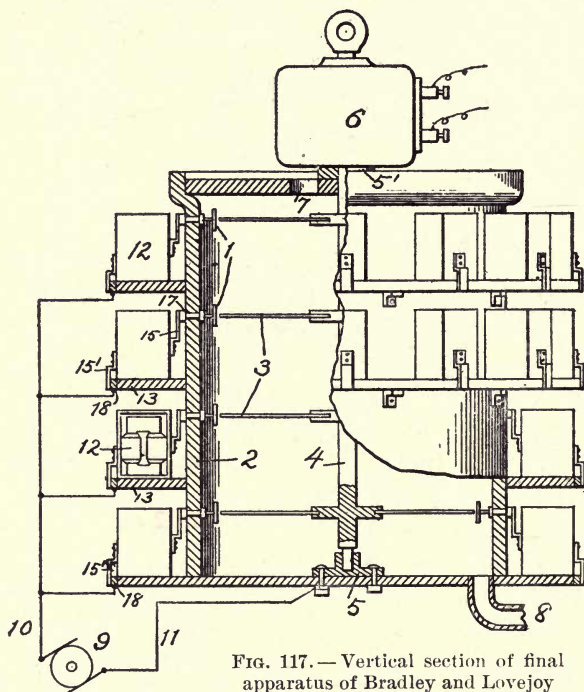

FIG. 117.— Vertical section of final apparatus of Bradley and Lovejoy

generator was especially designed for this plant, giving 8000 volts and 0.75 ampere. Air passed in at the rate of 11.3 cubic meters per second and came out of the cylinder containing 2.5 per cent nitric oxide.²¹ The yield is said to have been one pound of acid per 7 horse power hours, or 87 grams per kilowatt hour. The process was not successful, however, and the company was forced to give up the experiments in 1904.

²¹ Haber, *Z. f. Elektroch.* 9, 381, (1903).

Though the yield compared favorably with the calculations given above, the apparatus was very complicated and subject to considerable wear. The iron drum corroded rapidly in spite of the inside coating of asphalt paint.¹⁸

The first successful process for oxidizing nitrogen on a commercial scale is that of Birkeland and Eyde. A factory for carrying it out was started at Notodden, Norway, in May, 1905.²² The high voltage flame is formed between two electrodes consisting of water-cooled copper tubes 1.5 centimeters in diameter

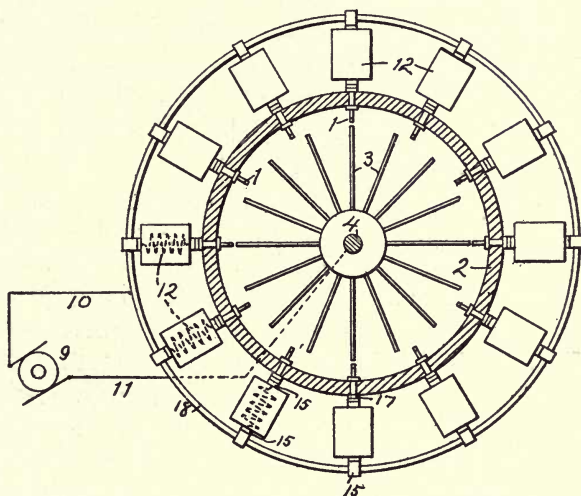

FIG. 118. — Horizontal section of final apparatus of Bradley and Lovejoy

with 0.8 centimeter between the ends. An alternating current of 50 cycles per second is supplied to the electrodes at 5000 volts. In order to spread the flame over a large area an electromagnet is placed at right angles to the electrodes so that the terminals lie between the poles of the magnet. The voltage is sufficiently high to cause the flame to form of itself between the electrodes at their nearest points, whereupon the magnetic field causes the ends of the flame to travel along the electrodes until the current is reversed. A new flame is then started on the other side of the electrodes. When the furnace

²² Birkeland, *Trans. Faraday Soc.* **2**, 98, (1906).

is running properly a flame is formed at each reversal of the current every $\frac{1}{50}$ of a second, though if the distance between

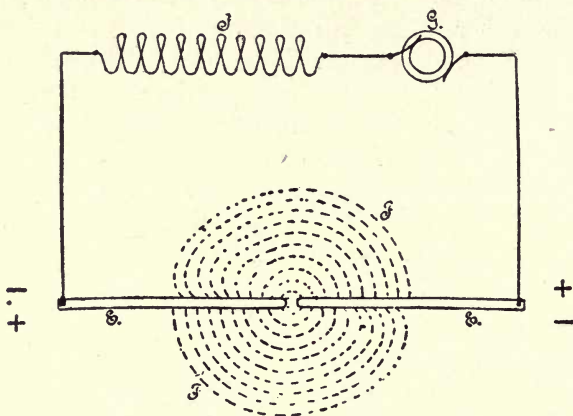

FIG. 119. — Electric disc in the furnace of Birkeland and Eyde

the electrodes is too short or the magnetic field too strong, several hundred flames may be started during one period. The

magnetic field is 4000 to 5000 lines per square centimeter at the center. The result of this combination is an electric disk flame, as shown in Figure 119. This is inclosed in a narrow iron furnace lined with fire brick, forming a chamber from 5 to 15 centimeters wide, shown in Figure 120. Air passes in through the walls and leaves

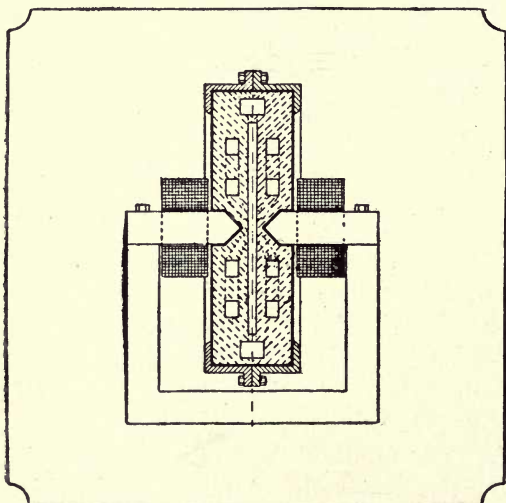

FIG. 120. — Vertical section of furnace of Birkeland and Eyde

the furnace at a temperature between 600° and 700° C., containing one per cent of nitric oxide. From the furnace the gases pass through a steam boiler in which they are cooled to 200° C., and then through a cooling apparatus in which their temperature is reduced to 50° C. They then enter oxidation chambers with acid proof lining, where the reaction $\text{NO} + \frac{1}{2} \text{O}_2 = \text{NO}_2$ is completed.

The next step is to absorb the nitrogen dioxide. This is done in two sets of five stone towers whose inside dimensions are $2 \times 2 \times 10$ meters. The first four towers are filled with broken quartz over which water trickles. The fifth tower is filled with brick, and the absorbing liquid is milk of lime, giving a mixture of calcium nitrate and nitrite. Nitric acid is formed in the first four towers with concentrations as follows:

FIRST	SECOND	THIRD	FOURTH
50 % HNO_3	25 % HNO_3	15 % HNO_3	5 % HNO_3

The liquid from the fourth tower is raised by compressed air to the top of the third, that from the third to the top of the second, and so on until fifty per cent nitric acid is formed. Some of this acid is used to decompose the nitrate-nitrite mixture from the fifth tower. The nitric oxide thereby evolved is sent into the absorbing system again. About 97 per cent of the entire quantity of nitrous gases passed through the absorbing system is absorbed.²³ The resulting solution of calcium nitrate and the rest of the stored-up acid is treated in another set of tanks with lime, producing neutral calcium nitrate. This is evaporated in iron by the steam from the boilers above mentioned till a boiling point of 145° C. is reached, corresponding to 75 or 80 per cent nitrate and containing 13.5 per cent of nitrogen. This is poured into iron drums of 200 liters capacity, where it solidifies. Another method is to crystallize from a boiling point of 120° C. This yields calcium nitrate with four molecules of water.

In 1906 at the Notodden Saltpeter Manufactory there were three 500-kilowatt furnaces in constant activity. The volume

²³ Eyde, *Electrochem. and Met. Ind.* 7, 304, (1909).

of air treated was 75000 liters per minute. The yield was about 500 kilograms of pure nitric acid per kilowatt year, or 57 grams per kilowatt hour.

In place of the smaller furnaces those now used absorb 1600 kilowatts, of which 35 are now in operation at Notodden, 8 in series. The disk flame has a diameter of 2 meters and a thickness of 10 centimeters.²⁴

During the year 1908 the profits of the Notodden factory were 25 per cent of the total receipts, amounting to 500,000 krone, or \$135,000.²⁵ The company using the Birkeland-Eyde process has combined with the Badische Anilin und Sodafabrik, which has developed another furnace, described below, so that the results of a factory under construction at Notodden in 1909 will decide which furnace will be the one for the final large plant.²⁵ Up to February, 1909, \$6,000,000 had been invested at Notodden and Svalgfos and on the rivers Rjukan and Vamma. By the end of 1910 these plants will be completed and the investment will amount to \$15,000,000.²⁵

The furnace of the Badische Anilin und Sodafabrik of Ludwigshafen, Germany, was invented in 1905 by Schönherr and Hessberger.²⁶ An alternating current arc is very easily extinguished, especially if air is blown across it. The principle underlying this furnace is that an alternating current arc loses its unstable character and becomes as quiet as a candle if a current of air is passed around it in a helical path. With this method of air circulation the arc may be included in a metallic tube without risk of its coming in contact with the sides of the tube. A cross section of the apparatus is shown in Figure 121. It consists of a number of concentric vertical iron tubes. The electrode at the bottom is an iron rod adjustable within a water-cooled copper cylinder. The iron is slowly eaten away, and is fed in at about the rate of one electrode in three months. The electrode *Z* is for starting the arc by bringing it in contact with

²⁴ Birkeland, *Electrochem. and Met. Ind.* **7**, 305, (1909).

²⁵ Eyde, *Z. f. Elektroch.* **15**, 146, (1909).

²⁶ *Electrochem. and Met. Ind.* **7**, 245, (1909); *Trans. Am. Electrochem. Soc.* **16**, 131, (1909).

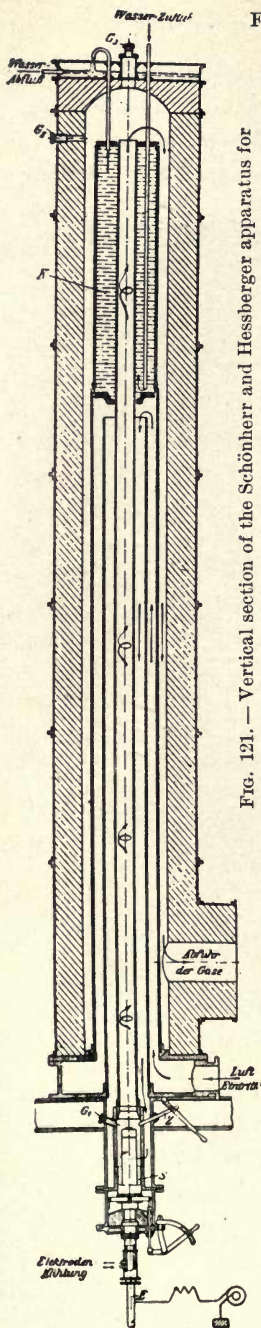

Fig. 121. — Vertical section of the Schönherr and Hessberger apparatus for oxidizing nitrogen

E. There is of course an induction coil in series with the arc to make it steady and prevent the current from being too large on starting. When *Z* is drawn back the arc is formed between *E* and the walls of the tube. The air then drives it up along the tube until it reaches the other water-cooled end, *K*, within which the arc terminates. G_1 , G_2 , and G_3 are peep holes for observing the ends of the arc. In the 600 horse power furnaces at Kristianssand, Norway, the arc is 5 meters long, and 7 meters in the 1000 horse power furnaces. The circulation of the air is evident from the figure.

The plant at Kristianssand, the furnace room of which is shown in Figure 122, has been in operation since the autumn of 1907. Three-phase currents are used, and the furnaces are connected in star. The power factor varies between 0.93 and 0.96. It is estimated that 3 per cent of the power is used in the formation of nitric oxide, 40 per cent is recovered in the form of hot water, 17 per cent is lost by radiation, 30 per cent is used in the steam boiler, and 10 per cent is removed by water cooling after the gases have passed the steam boiler. The nitric oxide is absorbed by milk of lime. The final product is calcium nitrite containing 18 per cent nitrogen. The yield per kilowatt hour is not given.

A third process for the fixation of atmospheric nitrogen, invented by H. and G. Pauling, is carried out near Inns-

bruck, Tirol, by the "Salpetersäure-Industrie-Gesellschaft."²⁷ The arcs are produced between curved electrodes, as shown in Figure 123. The arc is lighted where the electrodes are nearest together, is blown upwards by the hot air rising between

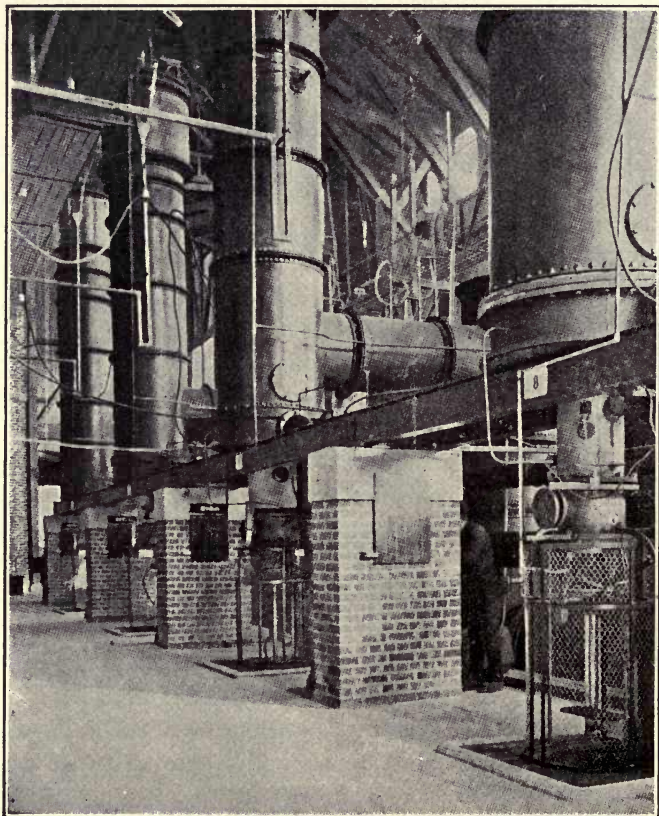

FIG. 122. — Furnace room at Kristianssand

the electrodes, and is broken every half period of the alternating current. Another arc is then formed, and so on. In Figure 123 *c* represents two thin adjustable blades for starting the arc. Air is blown in through the tube *e*. The electrodes are iron pipes, water-cooled and separated by about 4 centimeters at

²⁷ *Electrochem. and Met. Ind.* 7, 430, (1909).

their nearest point. Their life is about 200 hours. With a 400 kilowatt furnace of 4000 volts the length of the flame is about one meter. Cooling is produced by passing cold air into the upper part of the flame from the side. The concentration of the nitric oxide is about 1.5 per cent. The furnaces used have two arcs in series.

Six hundred cubic meters of air per hour pass through the furnace, excluding the cooling air. The yield is 60 grams of nitric acid per kilowatt hour. At present there are 24 furnaces in operation at

Innsbruck, having a capacity of 15,000 horse power. The products are nitric acid and sodium nitrite. Two other plants for carrying out this process, each of 10,000 horse power, are in course of erection, one in southern France and the other in northern Italy.

A number of other furnaces for the oxidation of nitrogen have been invented, but their descriptions are omitted here because they are not in operation on a commercial scale.

4. THE SYNTHESIS OF AMMONIA

The third method of fixing nitrogen, that has just recently been taken up by the Badische Anilin und Sodafabrik,¹ is to make it combine directly with hydrogen to form ammonia, according to the reversible reaction :

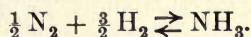

This reaction takes place from left to right with the evolution of about 12,000 calories,² so that the quantity of ammonia gas in the equilibrium mixture decreases as the temperature rises.

¹ Haber, *Z. f. Elektroch.* **16**, 242, (1910).

² Landolt and Börnstein's Tables, 3d ed. p. 427.

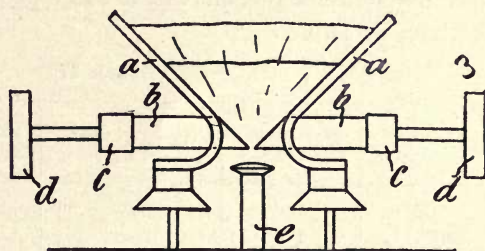

FIG. 123.—Electrodes in furnace of H. and G. Pauling

The velocity of the reaction, on the other hand, of course increases with the temperature, but does not reach a value that adjusts the equilibrium rapidly below a temperature of 750°C.³ The composition of the equilibrium mixtures for different temperatures and two different pressures, when the free hydrogen and nitrogen are present in the same proportion as in ammonia, is given in Table 37.⁴

TABLE 37

DEGREES CENTIGRADE	PRESSURE IN ATMOSPHERES	VOL. PER CENT NH ₃	PRESSURE IN ATMOSPHERES	VOL. PER CENT NH ₃
700	30	0.654	1	0.0221
801	30	0.344	1	0.0116
901	30	0.207	1	0.00692
974	30	0.144 to 0.152	1	0.0048 to 0.0051

It is evident from this table that unless some catalytic agent can be found that would give the reaction high velocity at a temperature considerably below 750°, very little ammonia could be obtained at atmospheric pressure. Since, however, there is a decrease in volume when ammonia is formed from an equivalent amount of nitrogen and hydrogen, there must be an increase in the relative amount of ammonia in an equilibrium mixture when the pressure is increased. It is evident from the table that the volume per cent of ammonia in such a mixture is directly proportional to the pressure, as long as the relative amounts of free hydrogen and nitrogen are kept constant.

Jost⁵ has obtained somewhat lower values for the amount of ammonia in the equilibrium mixture. Table 38 gives his results obtained at a total pressure of one atmosphere, and those of Haber taken from the table above for comparison.

Haber's results at one atmosphere are in good agreement with the values calculated from his results at 30 atmospheres, and therefore are more reliable than Jost's.

³ Haber, *Thermodynamics of Technical Gas Reactions*, p. 202, (1908).

⁴ Haber and Le Rossignol, *Z. f. Elektroch.* **14**, 193, (1908).

⁵ *Z. f. Elektroch.* **14**, 373, (1908).

TABLE 38

DEGREES CENTIGRADE	VOLUME PER CENT NH ₃	
	Haber	Jost
700	0.0221	0.018
800	0.0116	0.0090
900	0.0069	0.0050
974	0.0048 to 0.0051	0.0035

Haber has subsequently developed this process further and showed in a lecture¹ a small apparatus working at 185 atmospheres that produced hourly 90 grams of liquid ammonia. In the earlier experiments finely divided iron on asbestos was used as a catalyzer, but in these later experiments, uranium was substituted for iron. This method is said to require comparatively little power, and will therefore not be confined to places where cheap water power is available. No numerical values of the efficiency of this method, however, are given.

5. CONCLUSION

Having described the three general methods of fixing atmospheric nitrogen now in operation, it will be interesting to compare the actual amounts of nitrogen fixed for a given amount of power by the three methods. This is possible only for the absorption by carbide and the direct oxidation.

Since 12,000 horse power or 8850 kilowatts can fix 4,000,000 kilograms of nitrogen¹ per year as calcium cyanamide, one kilowatt hour corresponds to 51.6 grams of nitrogen. The yield by the Birkeland-Eyde process is about 57.1 grams of pure nitric acid per kilowatt hour,² corresponding to 12.7 grams of nitrogen. The cyanamide process therefore fixes about four times as much nitrogen as the direct oxidation for the same expenditure of power.

¹ Frank, *Z. f. angew. Ch.* **19**, 835, (1906).

² Birkeland, *Trans. Faraday Soc.* **2**, 98, (1906); Haber, *Z. f. Elektroch.* **10**, 551, (1906).

CHAPTER XV

THE PRODUCTION OF OZONE

1. GENERAL DISCUSSION

IN 1785 Van Marum observed that oxygen through which an electric spark had passed had a peculiar odor, and that it at once tarnished a bright surface of mercury.¹ Nothing was done to throw light on this phenomenon until 1840, when it was investigated by Schönbein. He had observed for a number of years previously that during the electrolysis of aqueous solutions an odor is produced in the gas evolved at the anode similar to that resulting from the discharge of electricity from points.² He described a number of the properties of this substance, and suggested the name ozone, from *ὄζων*, meaning *smelling*. For many years the chemical nature of this oxidizing principle was unknown, but it was found eventually, after a great number of investigations, to be simply condensed oxygen with the formula O₃.

The formation of ozone from oxygen is an endothermic reaction. The heat absorbed in the production of one mole of ozone, as determined by different investigators, is given in the following table:³

Berthelot, indirect, 1876	29,800 calories
Mulder and v. d. Meulen, indirect, 1883	33,700 calories
v. d. Meulen, indirect, 1882	32,800 calories
v. d. Meulen, direct, 1883	36,500 calories
Jahn, direct, 1908	34,100 calories

¹ Roscoe and Schorlemmer, *Treatise on Chemistry*, 1, 256, (1905).

² Pogg. Ann. 50, 616, (1840).

³ Stephan Jahn, *Z. f. anorg. Ch.* 48, 260, (1905).

Since heat is absorbed in the production of ozone, thermodynamics requires that the equilibrium existing in a mixture of oxygen and ozone be displaced in the direction of a greater ozone concentration by an increase in the temperature of the mixture. In order to prove this experimentally, it is necessary to heat the oxygen to a temperature high enough to produce a measurable quantity of ozone, and then, by cooling suddenly, to prevent the decomposition of the ozone formed. This has been done by blowing air or oxygen against a hot pencil, such as is used in a Nernst lamp,⁴ and also by dipping a hot Nernst pencil, or hot platinum, in liquid air.⁵

The free energy decrease which accompanies the decomposition of ozone into oxygen has been determined from potential measurements.⁶ At 0° C. the potential of the cell O₃ | electrolyte | H₂ equals 1.90 volts, and that of the cell O₂ | electrolyte | H₂ equals 1.25 volts. The reactions which take place in these two cells, with the corresponding free energy changes, are therefore given by the following equations :

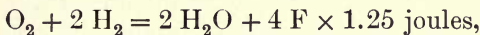
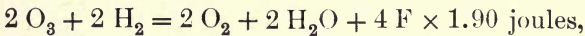

where F is the electrochemical equivalent. The difference between these two equations gives :

$$2 \text{O}_3 = 3 \text{O}_2 + 4 F \times 0.65, \text{ or } \text{O}_3 = \frac{3}{2} \text{O}_2 + 30,000 \text{ calories.}$$

From this result the following equilibrium concentrations at high temperatures may be calculated :

Temperature on absolute scale	1000°	1400°	1800°	2200°
Pres. ozone in atmospheres, in equilibrium with oxygen at one atmosphere	0.000029	0.0032	0.038	0.18
			(0.007)	(0.03)

The above results are only approximate, for the very divergent values inclosed in parentheses are within the experimental error.

⁴ Fischer and Marx, B. B. 40, 443, (1907).

⁵ Fischer and Braemer, B. B. 39, 996, (1906).

⁶ Stephan Jahn, Z. f. anorg. Ch. 60, 332, (1908).

It will be seen from these results that ozone, in the concentrations ordinarily prepared, amounting to several per cent by volume, is in a state of unstable equilibrium, and it consequently decomposes slowly on standing. This reaction is bimolecular;⁷ that is,

$$dn = -kn^2 dt,$$

where n is the number of moles per cubic centimeter, k is a constant, and t is the time. The velocity of this reaction is given in Table 39. β is the number of grams of ozone in one liter that would decompose per minute if its initial concentration were one gram per liter.

TABLE 39

TEMPERATURE	β
16°	0.0000492
100°	0.157
126.9°	1.77

At 16° one per cent of pure ozone would decompose in 1.7 hours, and 50 per cent in 167 hours. These values apply to ozone in contact with concentrated sulphuric acid, over which the pressure of water vapor is 0.0021 millimeter of mercury. If the pressure of water vapor is 0.154 millimeter, the velocity of decomposition at 100° is found to be 22 per cent greater.

The decomposition of ozone takes place in steps, the reaction whose velocity is measured being

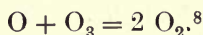

Ozone may be produced by the action of ultra-violet light, and of the silent discharge of electricity on oxygen; by heating and suddenly chilling oxygen, and by electrolysis. While the silent electric discharge is the only method used commercially for the manufacture of ozone, it will be interesting to

⁷ Warburg, Ann. d. Phys. **9**, 1286, (1902), and **13**, 1080, (1904).

⁸ Jahn, Z. f. anorg. Ch. **48**, 260, (1905).

compare the yield per kilowatt hour attained by the silent discharge with some of the other methods. By blowing air against a hot Nernst pencil, the yield was found to be one gram⁴ per kilowatt hour; and by dipping hot bodies in liquid air, about 3.5 grams.⁵ The concentration of the ozone in both cases was less than three per cent. By electrolyzing solutions of sulphuric acid of specific gravity between 1.075 and 1.1 with a water-cooled platinum anode, as high as 17 per cent by weight of the oxygen given off at the anode has been obtained in the form of ozone.⁹ Assuming three volts sufficient to electrolyze the solution, the yield in oxygen per kilowatt hour would be 10 grams, and if 17 per cent of this were ozone, the yield would be only 1.7 grams per kilowatt hour. When compared with 70 grams per kilowatt hour, the yield obtained with the silent discharge, these methods are seen to be inefficient from an economical standpoint, though if a high concentration is desired, this can be best obtained by electrolysis.

There are two distinct forms of silent discharge of electricity, which differ in their appearance, in the amount of ozone which they produce, and in the current which is required to produce them.¹⁰ If a point one centimeter distant from a plate connected to earth is charged negatively to 7000 volts in air, a bluish light surrounding the point can be seen with the naked eye. If the potential is raised, a reddish broad brush appears, separated from the bluish light by a dark space, while the opposite plate remains dark. These different parts of the discharge correspond to what is observed in a vacuum tube in which the air is at a pressure of a few millimeters of mercury. The bluish light corresponds to the negative glow, the dark space to the Faraday dark space, and the reddish light to the positive column of light.

With a positively charged point and a low potential difference, a reddish envelope of light is first observed, from which a brush is developed on increasing the potential. The ability

⁹ Fischer and Massenez, *Z. f. anorg. Ch.* **52**, 202, (1907).

¹⁰ Askenasy, *Technische Elektrochemie*, p. 240, (1910); and Warburg, *Ber. d. deutsch. phys. Ges.*, (1904), 209.

to form this brush is important for the ozone formation, and is lost by points after use. In place of it a spark discharge is produced; but the brush discharge can be produced even on old points by placing a spark gap 0.1 millimeter long before the point.

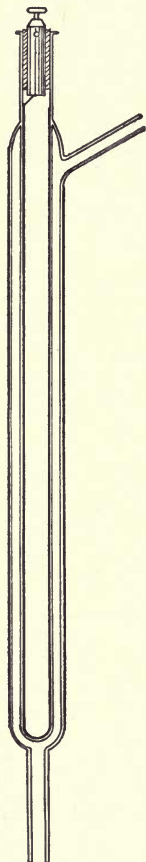

FIG. 124. — Longitudinal section of Siemens's original ozonizer

If the discharge takes place between parallel conducting plates, either one or both being covered with a dielectric, the case is more complicated.¹¹ This type of ozonizer was devised by W. von Siemens and is usually called by his name.¹² Siemens's original ozonizer consisted of concentric tubes, as shown in Figures 124 and 125. Two such tubes, with the sides *a* and *d* covered with a conductor, such as tin foil, may be looked upon as a series of condensers connected in series, with an ohmic resistance in parallel with one of them. In this case there would be three condensers: *ab*, *bc*, and *cd*; while if the inner tube is bare metal there would be only two: *bc* and *ab*. When the space *bc* is filled with a perfect insulator or with a perfect conductor, the current has its smallest or its largest value, respectively. In both cases the apparatus is a perfect condenser and absorbs no energy, since $\cos \phi = 0$, where ϕ is the angle of phase difference between the voltage and the cur-

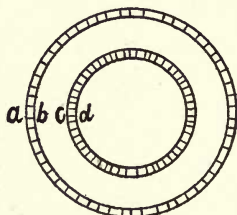

FIG. 125. — Transverse section of Siemens's ozonizer

rent. For an average conductivity in *bc*, such as a gas can have, $\cos \phi$ assumes its largest value. In actual practice all

¹¹ Askenasy, p. 242; Warburg and Leithäuser, *Ann. d. Phys.* **28**, 1 and 17, (1908).

¹² *Pogg. Ann.* **102**, 120, (1857).

possible values of $\cos \phi$ between 0 and 1 may occur. With increasing current strength $\cos \phi$ decreases, probably because the resistance of the gas decreases with increasing current. If the frequency of the alternating current increases, $\cos \phi$ increases and approaches 1. High frequencies, between 200 and 500 per second, should therefore be used. Ozonizers with one tube bare metal are better than those with both tubes glass, for $\cos \phi$ is larger, and a larger current passes, for a given voltage, than in a glass apparatus of the same dimensions.

If an alternating electromotive force is applied between a point electrode and a plate connected to earth, the positive brush appears. By means of a rotating mirror the positive and negative light can be seen alternately on the point, and its appearance is not much changed when the plate is covered with an insulator.¹¹ If a Siemens apparatus has a large current passing, a uniform luminosity appears in the space between the electrodes, but if the current density is sufficiently lowered, brushes are formed at single points on the electrodes. From the appearance of these discharges, there is no doubt that the same process takes place in the Siemens apparatus as in one with point and plate electrodes, except that in the Siemens ozonizer the effects on positive and on negative points are superimposed, as in the case of a direct current between two metallic points.

The production of ozone by the silent discharge of electricity may be considered from the following different points of view : (1) the maximum concentration that can be obtained, (2) the maximum number of grams that can be produced per coulomb of electricity, and (3) the maximum number of grams per unit of power. The latter consideration is, of course, of the most technical importance. As stated above, ozonizers with point electrodes give different results, depending on whether the points are positive or negative to the plate. The Siemens ozonizer is a third case to be considered. The amount of ozone produced per coulomb is therefore a variable quantity, and follows no known law, such as we have in Faraday's law in the case of electrolysis. In the absence of such a law, it will be necessary to show what the yield is under different conditions

and how this is affected by changing the conditions. In order to give a systematic survey of this subject, the maximum concentration will first be discussed for the three cases enumerated above, and the yields per unit of electricity and per unit of power, including the factors that affect them, will then be taken up in the following order, (1) for points negative, (2) for points positive, and (3) for Siemens ozonizers.

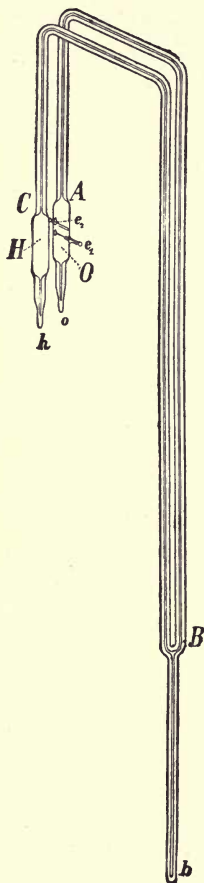

FIG. 126. — Apparatus for determining the maximum attainable concentration of ozone

The Maximum Concentration

The silent discharge of electricity has a deoxygenizing effect on ozone, as well as an oxygenizing effect on oxygen. The oxygenizing effect of the discharge is proportional to the concentration of the oxygen, and the deoxygenizing effect to that of the ozone. In other words, this reaction follows the mass action law. If the discharge passed for an infinite time, a limiting concentration of ozone would be reached, at which the amount decomposed per second would equal the amount produced. These two different effects have been studied separately by E. Warburg.¹

The experiments were carried out in the apparatus shown in Figure 126. The ozonizer *O* was connected with an auxiliary vessel *H* by a capillary tube filled with sulphuric acid to a proper distance above *B*. *O* and *H* each had a volume of a little over one cubic centimeter. The point electrode e_1 was a platinum wire 0.05 millimeter in diameter; the earth electrode e_2 was a platinum wire 0.5 millimeter in diameter bent in the form of a U to increase the surface. After filling the appara-

¹ Ann. d. Phys. 9, 781, (1900).

tus with oxygen and sealing off at h , o , and b , the rate at which ozone was produced, and the concentration, could be observed by the change in the height of the sulphuric acid in the manometer. Table 40 gives the results obtained with e_1 connected to the negative pole of an electrostatic machine and e_2 through a galvanometer and to earth. β is a constant proportional to the rate of formation of ozone at a given temperature, and α is a constant proportional to its decomposition.

TABLE 40

TEMPERATURE	PER CENT OZONE BY VOLUME	β = A CONSTANT PROPORTIONAL TO RATE OF FORMATION	α = A CONSTANT PROPORTIONAL TO THE RATE OF DECOMPOSITION
+ 93	1.23	0.0177	1.42
50	2.22	0.0214	0.939
17	3.53	0.0225	0.616
0	4.19	0.0219	0.503
- 71	5.74	0.0232	0.380

This table shows that the maximum concentration decreases as the temperature rises, and that this is due to the increasing decomposing effect of the discharge, and not to a smaller ozonizing effect. This is evident from the values of α and β . The spontaneous decomposition of the ozone was negligible. The ozonizer was then replaced by the one shown in Figure 127 with a volume of 7.5 cubic centimeters. The point electrode e_1 consisted of a platinum wire 0.05 millimeter thick, and the earth electrode e_2 was a half cylindrical platinum plate. In this ozonizer the positive, as well as the negative, point discharge could be obtained. In both cases faint, luminous points were visible in the dark on the thin wire, while the earth electrode remained dark. With a current of 33 microamperes the results in Table 41 were obtained.

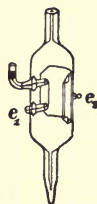

FIG. 127. — Ozonizer replacing O in preceding figure

TABLE 41
Point Electrode Negative

TEMP.	MAXIMUM CONCENTRATION PER CENT OZONE BY VOL.	β = CONST. PROPORTIONAL TO RATE OF FORMATION	α = CONST. PROPORTIONAL TO RATE OF DECOMPOSITION
48	2.41	0.00824	0.332
19	3.38	0.00807	0.231
0	4.45	0.00929	0.198

Point Electrode Positive

48	0.81	0.00243	0.297
19	1.06	0.00258	0.233
0	1.42	0.00278	0.198

From these results it is evident (1) that the maximum concentration with the point negative is about three times as great as with the point positive; (2) that this is due to the greater ozonizing effect of the discharge when the point is negative, since the deozonizing effect is approximately the same in both cases; and (3) the temperature effect is the same for the positive as for the negative point discharge.

For the Siemens type of apparatus the limiting concentration of ozone produced from 96 per cent oxygen diminishes slightly with increasing current, as shown by the following table:²

TABLE 42

TEMPERATURE	AMPERES $\times 10^3$	OZONE	
		GRAMS PER CUBIC METER	PER CENT BY VOLUME
19	1.21	168	8.02
19	3.00	165	7.90
Apparatus changed			
24	1.33	114	5.46
24	2.16	110	5.27

² Warburg and Leithäuser, Ann. der Phys. 28, 31, (1909).

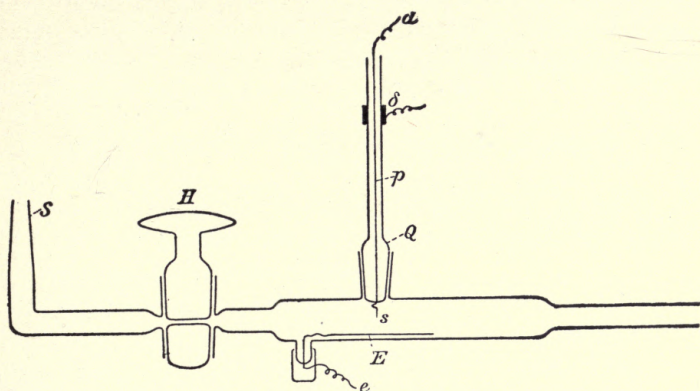

Fig. 128. — Experimental ozonizer

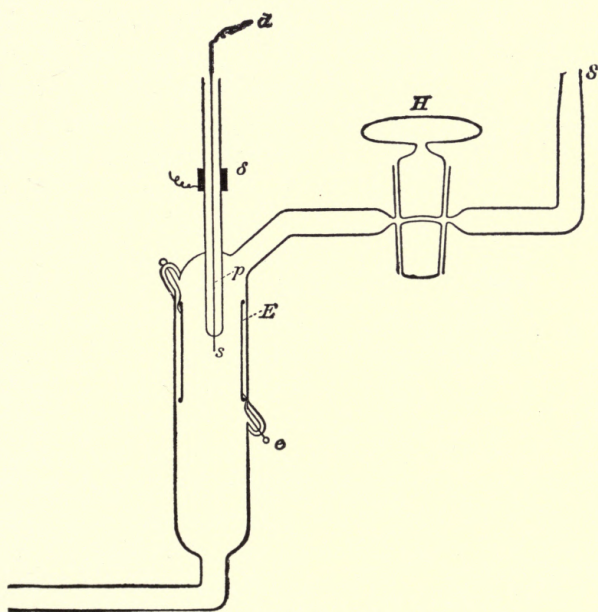

Fig. 129. — Experimental ozonizer

The limiting concentration is evidently a quantity that varies with the apparatus used. The highest value obtained is 211 grams per cubic meter, or 10.1 per cent by volume.³

Yield per Coulomb for Negative Point Electrode

In order to produce the maximum amount of ozone per coulomb, the deozonizing effect of the electric discharge must be excluded. This may be accomplished by passing the oxygen through the ozonizer so rapidly that the concentration of the ozone produced remains very low compared with the maximum concentration attainable. In a number of the experiments referred to below, the concentration of ozone did not exceed one per cent of the maximum. A number of different forms of apparatus with a point electrode were used by Warburg in determining these yields. In the apparatus shown in Figure 128, *E*, the earth electrode, is a platinum plate; in Figure 129 *E* is a platinum cylinder; and in Figure 130, consisting of a liter bottle, *E* is concentrated sulphuric acid. Figure 131 shows an ozonizer with a number of point electrodes.

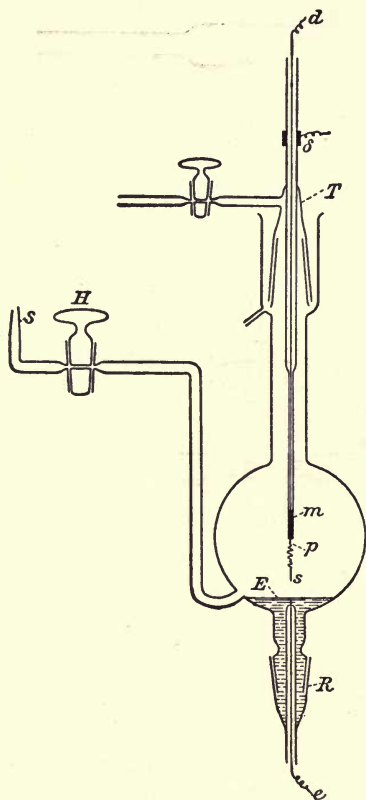

FIG. 130.—Experimental ozonizer

With the point negative, for a given current strength the yield per coulomb is independent

³ Warburg and Leithäuser, *Ann. der Phys.* **28**, 25, (1909).

of the voltage, as shown by the results of Table 43,¹ obtained with oxygen 93 per cent pure by volume. In the following tables the current given is for one point only, in case the apparatus contained more than one point.

TABLE 43

AMPERES $\times 10^6$	VOLTS	GRAMS OZONE PER COULOMB
57	4200	0.0375
57.5	9880	0.0386
57.2	11,700	0.0387

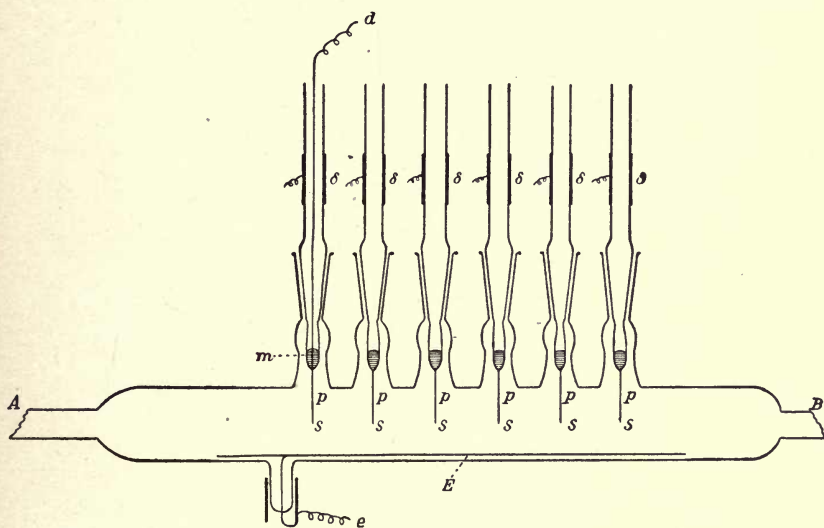

FIG. 131. — Experimental ozonizer

The yield is also independent of the form of the anode, and decreases slowly with increasing current, as is shown by the following results obtained with different forms of anode:¹

¹ Warburg, Ann. der Phys. 13, 472, (1904).

TABLE 44

APPARATUS IN FIG. 128		APPARATUS IN FIG. 129	
Amperes $\times 10^6$	Grams Ozone per Coulomb	Amperes $\times 10^6$	Grams Ozone per Coulomb
17.4	0.0484	29.1	0.0431
25.1	0.0459	57.5	0.0386
57.2	0.0375	94.2	0.0370

These results are for the case where negative light appears only on the point. If it appears at other parts of the electrode, the yield may increase with the current. The yield depends further on whether the points have been previously used, being greater for previously used points : ²

TABLE 45

Oxygen, 96 per cent pure, by volume

TIME DURING WHICH OZONIZER WAS USED BETWEEN EXPERIMENTS	VOLTS	AMPERES $\times 10^6$	GRAMS OZONE PER COULOMB
—	6080	14.6	0.0408
125 min.	6960	21.9	0.0452
165 min.	6420	17.5	0.0803
75 min.	6300	17.5	0.0873
30 min.	8800	17.5	0.0908

This increase in the yield is accompanied by a change in the character of the light on the electrode. When the final state of the electrode has been reached the yield decreases for increasing current to a certain point, as shown by the results in Table 46 of experiments with 98.5 per cent oxygen : ³

² Warburg, Ann. d. Phys. 17, 6, (1905).

³ Warburg, Ann. d. Phys. 17, 6, (1905).

TABLE 46

VOLTS	AMPERES $\times 10^6$	GRAMS OZONE PER COULOMB	GRAMS OZONE PER KILOWATT-HOUR
7230	8.83	0.0950	47.3
8800	17.50	0.0908	37.1
12,500	52.30	0.0485	14.0

If the current is increased to a still higher value, the yield reaches a minimum and then increases with the current. This is shown by the results in Table 47, obtained with new points and with oxygen 96 per cent pure by volume :⁴

TABLE 47

VOLTS	AMPERES $\times 10^6$	GRAMS OZONE PER COULOMB
6080	14.6	0.0423
—	21.9	0.0340
9610	52.4	0.0307
12,510	130.7	0.0422
7000	21.9	0.0375

In this case also a marked change in the appearance of the light accompanies the increase in the yield after passing the minimum. After a certain amount of practice, it is even possible to predict from the appearance of the light what the yield will be.⁵

In changing the temperature and pressure of the gas, not only the substance which is to be acted upon is altered, but also the agent which brings about the reaction ; for the light changes its character when the physical state of the gas through which the current is passed is altered. This fact complicates the study of this subject. The results in Table 48 with oxygen 98.5 per cent pure by volume show how the yield increases with the pressure :⁶

⁴ Ann. d. Phys. 17, 10, (1905).⁵ Ann. d. Phys. 17, 7, (1905).⁶ Ann. d. Phys. 17, 12, (1905).

TABLE 48

PRESSURE IN MM. OF MERCURY	VOLTS	GRAMS OZONE PER COULOMB	REMARKS
460	3810	0.0365	Points previously sub- jected to long use. Current = 37.4×10^{-6} ampere Fresh points. Current = 17.5×10^{-6} ampere
784	5220	0.0522	
1210	6900	0.0903	
465	5520	0.0355	
780	7410	0.0477	
1208	9700	0.0597	

Between 780 and 460 millimeters pressure, the yield A_p for any pressure p is given by the equation ⁷

$$A_p = A_{760} [1 - (760 - p) 0.00089].$$

The temperature of the gas in all of these experiments lay between 17° and 23°. Table 49 shows the effect on the yield of changing the temperature :

TABLE 49

Oxygen 98.5 per cent pure by Volume. Current 37.4×10^{-6} Ampere

PRESSURE IN MM. OF MERCURY	TEMPERATURE	VOLTS	GRAMS OZONE PER COULOMB
785	16.5	7530	0.0418
782	79.5	6560	0.0376
789	14.8	7500	0.0430
789	80.1	6440	0.0395
788	14.2	7470	0.0430
780	79.7	6320	0.0387
786	15.4	7350	0.0429
786	79.8	6320	0.0394

This decrease in the yield is largely due to the decrease in the density of the oxygen when the temperature is raised. If the pressure is increased enough to keep the density constant, the yield is very little affected. This is shown in Table 50, obtained with points not previously used :

⁷ Ann. d. Phys. 28, 21, (1909).

TABLE 50

PRESSURE IN MM. OF MERCURY	TEMPERATURE	VOLTS	AMPERES $\times 10^6$	GRAMS OZONE PER COULOMB
783	12.4	6440	17.5	0.0403
951	80.0	5970	17.5	0.0413
775	11.8	6350	17.5	0.0458
963	80.0	6180	17.5	0.0480
782	10.4	10,190	52.4	0.0389
979	80.3	8860	52.4	0.0370
792	15.0	9470	52.4	0.0394
980	80.0	8920	52.4	0.0388

It is therefore evident that if the density is constant, the yield is changed only a few per cent between 10 and 80 degrees.

The relation between the yield per coulomb and the concentration of the ozone produced from 98 per cent oxygen is linear.⁸ If the concentration is allowed to reach 12.9 grams per cubic meter, the yield falls to 75 per cent of its value for a concentration of 1.3 to 1.6 grams per cubic meter. The formula

$$A = 0.166 - 0.00215c$$

gives the yield per coulomb for different values of the concentration c between 1.6 and 12.9 grams per cubic meter, and for a current of 0.0175×10^{-3} ampere. The yield per kilowatt hour is given by the equation :

$$B = 71.0 - 1.58c + 0.00090c^2.$$

These results were obtained with spheres, in place of points, 1.5 to 2 millimeters in diameter, melted on a wire 1 millimeter in diameter. The yield for this kind of electrode is much higher than for points, and when used as the positive pole, spheres do not show the aging effect that is observed with points.

The presence of water vapor in oxygen reduces the yield nearly proportionally to the pressure of the water vapor.⁹ The reduction in the yield for seven millimeters pressure is

⁸ Warburg and Leithäuser, Ann. d. Phys. **20**, 734, (1906).

⁹ Ann. d. Phys. **20**, 751, (1906).

about 94 per cent of its value for dry oxygen. There is also a great tendency for the formation of sparks when the gas is moist.

When oxygen is mixed with only 7 per cent of nitrogen, the silent discharge produces no oxide of nitrogen,¹⁰ but when air is used oxides of nitrogen are produced. The spark discharge produces only oxides, and these prevent the formation of ozone.¹¹ For air, the yield per coulomb is independent of the voltage for a constant current, as in the case of oxygen, but it is much smaller than for oxygen. This is shown in Table 51.¹²

TABLE 51

Air. Temperature 20°. Six Points. Current for One Point = 21.9×10^{-6} ampere

VOLTS	DISTANCE BETWEEN POINT AND PLATE IN MILLIMETERS	GRAMS OZONE PER COULOMB
8240	12.8	0.0112
8300	12.8	0.0110
3930	3.4	0.0110
7950	13.5	0.0110

For air, the yield first decreases with increasing current and reaches a minimum, after which it increases more rapidly than for oxygen, as shown in Table 52.

TABLE 52

AMPERES $\times 10^6$	VOLTS	DISTANCE BETWEEN POINT AND PLATE IN MILLIMETERS	GRAMS OZONE PER COULOMB
21.9	8300	12.8	0.01100
54.5	—	—	0.00935
55.2	7830	7.5	0.00766
163.0	12,200	7.5	0.01880
219.0	12,940	7.5	0.02500

¹⁰ Warburg, *Ann. d. Phys.* **13**, 470, (1904).

¹¹ Warburg and Leithäuser, *Ann. d. Phys.* **20**, 743, (1906).

¹² Warburg, *Ann. d. Phys.* **17**, 25, (1905).

The change that takes place in the luminosity when the yield begins to increase is similar to that in the case of oxygen.

The effect of the concentration of the ozone produced on the yield in air is approximately the same as in oxygen.¹³ A , the yield in grams per coulomb, and B , the yield in grams per kilowatt hour, are given by the following equations, for values of the concentration c between 2.19 and 9.62 grams per cubic meter :

$$A = 0.0780 - 0.00220 c,$$

$$B = 42.6 - 1.60 c + 0.0036 c^2.$$

The effect of moisture is greater for air than for oxygen, 7 millimeters pressure of water vapor reducing the yield to 69.7 per cent of its value for dry air.¹⁴

The effect of temperature on the yield for negative points in air has not been determined.

Yield per Coulomb for Positive Point Electrode

The effect of increasing the current on a positive point electrode is quite different from the effect on a negative point. With positive points the yield is smallest for small currents, but increases as soon as the positive brush appears, and, with points not previously used, it finally reaches values exceeding the highest ones obtainable with negative points. This is shown in Table 53.¹ The yield is very much affected by the character of the positive brush, which depends on a number of circumstances difficult to control.

The effects of temperature and pressure on the yield with positive points in oxygen have not been investigated.

The relation between the yield in grams per coulomb, A , and the concentration of ozone, c , produced, is given by the equation :

$$A = 0.166 - 0.00853 c,$$

¹³ Warburg and Leithäuser, Ann. d. Phys. **20**, 734, (1906).

¹⁴ Ann. d. Phys. **20**, 734, (1906).

¹ Warburg, Ann. d. Phys. **17**, 19, (1905).

which holds for values of c between 1.18 and 8.49 grams per cubic meter.² The corresponding equation for grams per kilowatt hour is

$$B = 67.0 - 3.44 c.$$

These results are for spheres in place of points, and for a current on one sphere of 0.033×10^{-3} ampere.

TABLE 53
93 per cent Oxygen by Volume

DIAMETER OF WIRE OF + POLE IN MILLIMETERS	DISTANCE BETWEEN POLES IN MILLIMETERS	TEMP. CENTI- GRADE	VOLTS	AMPERES $\times 10^6$	GRAMS OZONE	
					Per Coulomb	Per Kilowatt Hour
0.1	13.5	16	12,900	77.2	0.0372	10.4
0.5	3.6	17	5710	22.9	0.0499	31.4
0.5	13.5	16	12,900	87.4	0.0795	22.2
1.0	4.0	18	6900	42.5	0.0871	45.4
1.0 copper	4.0	18	5590	29.4	0.0760	48.9
1.0	4.0	18	5970	43.9	0.0856	51.5

98.5 per cent Oxygen

1	4.4	20	7830	47.9	0.0947	43.8
2	5	19	7710	62.4	0.0680	31.8

The reduction in the yield by water vapor is much greater for positive points in oxygen than for negative. When the vapor pressure of the water is seven millimeters, the yield is only 64 per cent of its value for dry oxygen.³

Positive points in air act similarly to positive points in oxygen, except that the positive brush is more capricious in air.⁴ The yield is much smaller than for negative points as long as no positive brush appears, and while the positive glow covers the point in a thin layer; but with the appearance of

² Warburg and Leithäuser, *Ann. d. Phys.* **20**, 739, (1906).

³ *Ann. d. Phys.* **20**, 753, (1906).

⁴ Warburg, *Ann. d. Phys.* **17**, 26, (1905).

the positive brush the yield increases and reaches values much higher than any obtained with negative points in air. This will be seen from the results of Table 54.

TABLE 54
Atmospheric Air. Positive Points of wire 0.25 mm. in Diameter

DISTANCE BETWEEN POINT AND PLATE	VOLTS	AMPERES $\times 10^6$	GRAMS OZONE	
			Per Coulomb	Per Kilowatt Hour
13.5	7950	14.6	0.00294	—
13.5	8060	14.5	0.00288	—
7.5	8060	32.7	0.00307	—
3.5	5340	36.4	0.0377	25.4 } Voltage near 26.1 } sparking 16.8 } point
3.5	5340	36.4	0.0387	
9.8	10,800	100.7	0.0505	

The yield in grams per coulomb, A , and in grams per kilowatt hour, B , in air are given by the equations:

$$A = 0.114 - 0.00867 c,$$

$$B = 60 - 6 c$$

for values of c between 0.58 and 3.94 grams per cubic meter.

The effect of water vapor on the yield with positive points in air is the greatest of any so far considered. In this case, for a pressure of water vapor of 7 millimeters, the yield falls to 49.1 per cent of its value for dry air.

It is evident, from the fact that positive points near the sparking potential give a better yield than negative points, both for oxygen and for air, that if an alternating current is used the yield will not be as good as with a direct current with positive points, for with an alternating current the points will be negative half of the time. This has been tested by direct comparison for oxygen and air. The results are given in Table 55.⁵

⁵ Warburg, Ann. d. Phys. 17, 29, (1905).

TABLE 55
98.5 per cent Oxygen. Temperature 19

DISTANCE OF POINT FROM PLATE IN MM.	CURRENT	VOLTS	AMPERES $\times 10^6$	GRAMS OZONE	
				Per Coulomb	Per Kilo-watt Hour
6.8	Alternating	6780	53.0	0.0258	13.7
6.8	Direct	8860	70.8	0.0612	24.9
4.4	Alternating	5340	37.0	0.0128	8.6
4.4	Direct	7830	47.9	0.0947	43.5
Atmospheric Air					
5	Alternating	5220	42.0	0.0190	13.0
5	Direct	6720	52.6	0.0523	28.2
5	Alternating	5590	62.1	0.0142	9.1
5	Direct	7120	54.2	0.0443	22.4

The Yield per Kilowatt Hour for Positive and for Negative Points

It is evident from what has preceded that the yield per unit of energy depends on a large number of factors. For negative points, it is best to use the smallest possible current and a short distance between the points and the plate, and the points should not be fresh. For positive points, heavy, new wires one millimeter thick are best, and the potential should be as high as possible without producing sparks. The distance between point and plate should not be too great, for though the yield per coulomb increases, the yield per kilowatt hour decreases, as seen in Table 54.

Much better yields both for positive and for negative points are obtained by substituting small spheres 1.5 to 2 millimeters in diameter for the points, as is seen in the results on the effect of concentration on the yield of ozone. It can be calculated from the equations given above, that for air, concentrations up to 4 grams per cubic meter are produced most economically

when the points are positive and the current high, while concentrations between 4 and 9 grams per cubic meter are most economically produced with negative points and low currents.¹ About 30 grams per kilowatt hour can be obtained in the latter case for a concentration of 8 to 9 grams per cubic meter.

Theory of Ozone Formation by the Silent Discharge

That the formation of ozone is not electrolytic in its nature¹ can be shown from the yields given above, which vary between 0.003 and 0.1 gram per coulomb. Since one equivalent of hydrogen reduces 24 grams of ozone, 24 may be taken as the latter's equivalent weight. The number of coulombs required to produce 24 grams of ozone therefore lies between 8000 and 240, numbers not at all comparable with the electrochemical equivalent, 96,540 coulombs. On the other hand, the energy required is considerably greater than the heat of the reaction. On the basis of the highest yield of 70 grams per kilowatt hour (see the equation for yield with negative points in oxygen), the energy required for one mole of ozone is 589,000 calories, 20 times as much as the heat of the reaction. Warburg's theory is that ozone is formed by those electrons that have a velocity as high as that required for the production of luminosity. Ozone may be formed directly by the impact of such electrons with oxygen molecules or by the intermediate production of short ether waves.²

*The Siemens Ozonizer*¹

The effect of pressure is the same in a Siemens ozonizer as for a point and plate, both being represented by the formula given above :

$$A_p = A_{760}[1 - (760 - p)0.00089].$$

¹ Warburg and Leithäuser, Ann. d. Phys. **20**, 742, (1906).

¹ Warburg, Ann. d. Phys. **13**, 474, (1904).

² Warburg, Ann. d. Phys. **17**, 7, (1905).

¹ Warburg and Leithäuser, Ann. d. Phys. **28**, 17, (1909). The following discussion is taken from this article, except where other references are given.

In air the pressure of oxygen is 160 millimeters, and in 96 per cent oxygen, 730 millimeters. Substituting these values in the above equation,

$$A_{160} = 0.48 A_{730}.$$

This relation is verified by the following results, in which the gas was passed through the ozonizer at such a rate that the concentration remained low. The effective current was measured.

TABLE 56

CURRENT PER SQUARE METER	GRAMS OZONE PER COULOMB		$\frac{A_{160}}{A_{730}}$	REMARKS
	In Oxygen	In Air		
0.146	0.0634	0.0194	0.31	50 alternations per second. Apparatus: 2 concentric glass tubes
0.193	0.151	0.0662	0.44	
0.133	0.238	0.115	0.49	
0.159	0.216	0.106	0.48	Central tube is bare metal
0.182	0.204	0.106	0.52	
0.182	0.288	0.146	0.51	

The quantity of ozone produced per coulomb for a given apparatus increases with the potential as in the case of positive points, and the effect of water vapor is to lower the yield.²

A factor not considered in Warburg's work, but one which has a great effect on the yield, is the transparency of the glass of the ozonizer for ultra-violet light.³ An ozonizer of quartz, for example, which is transparent to ultra-violet rays, gives only half as much ozone, other conditions being equal, as a glass ozonizer of the same dimensions.

The relation between the yield and the concentration of the ozone leaving the ozonizer is similar to that for points, and is given in Table 57.

The formation of ozone is proportional to the mean current, $\frac{2}{T} \int_0^T i dt$, and not to the effective current, $\sqrt{\frac{1}{T} \int_0^T i^2 dt}$, the value

² A. W. Gray, Phys. Rev. **19**, 362, (1904).

³ F. Russ, Z. f. Elektroch. **12**, 409, (1906).

given by measuring instruments ; consequently, if the effective current is measured, the yield will also depend on the wave form of the current.

TABLE 57

Oxygen 96 per cent pure. Maximum Concentration of Ozone equals 168 Grams per cubic meter

CONC. OZONE IN GRAMS PER CUBIC METER	GRAMS OZONE PER COULOMB	CONC. OZONE IN GRAMS PER CUBIC METER	GRAMS OZONE PER COULOMB
16.1	0.121	53.1	0.104
23.2	0.120	62.4	0.102
29.9	0.116	68.4	0.100
31.2	0.115	80.6	0.095
41.1	0.111		

The effect of temperature is similar to that in the apparatus with point and plate electrodes : the yield for zero concentration changes very little, while the deozonizing effect of the current on the ozone already formed increases with the temperature.

The yield per kilowatt hour is greater where one electrode is not covered with an insulator, because of the greater current for a given voltage and the greater value of $\cos \phi$. The thickness of the dielectric has no effect.⁴ The following table gives the yield obtained by Warburg and Leithäuser in grams ozone per kilowatt hour.⁵

TABLE 58

Air

DISTANCE BETWEEN PLATES IN MM.	FREQUENCY	GRAMS PER KILOWATT-HOUR FOR		AMPERES PER SQUARE METER
		Conc. = 4 grms. per m ³ .	Conc. = 10 grms. per m ³ .	
2.26	50	78.4	72.2	0.182
2.26	100	81.4	75.7	0.308
2.26	500	66.0	57.1	1.580
4.66	50	62.4	53.3	0.169
4.66	100	63.0	54.0	0.280
4.66	500	58.0	33.0	1.190

⁴ See also Ewell, Phys. Rev. **22**, 243, (1906).

⁵ Ann. d. Phys. **28**, 36, (1909).

It will be noticed that the yield for a Siemens ozonizer is considerably higher than for those having a point and a plate electrode, for which the highest value was 36 grams per kilowatt at a concentration of 4 grams per cubic meter.

2. THE TECHNICAL PRODUCTION OF OZONE

Ozone is produced commercially for the purification of water, for bleaching, and for use as an oxidizing agent in organic chemistry.¹ In water purification, the action of ozone is to oxidize the organic matter and to destroy germs.

Siemens and Halske make the ozone apparatus shown in Figure 132.² The discharge chamber is between two concentric metal cylinders, between which 8000 volts alternating are applied. The cylinders are

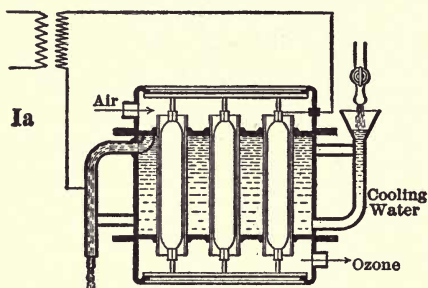

FIG. 132. — The Siemens and Halske ozonizer

immersed in water for cooling, and the outer one is connected to earth. One of the surfaces from which the discharge takes

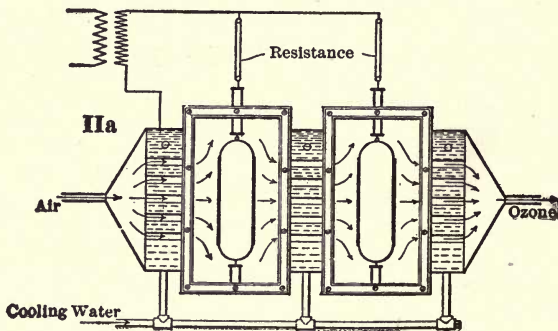

FIG. 133. — The Tindal ozonizer

immersed in water for cooling, and the outer one is connected to earth. One of the surfaces from which the discharge takes

¹ J. W. Swan, *Z. f. Elektroch.* 7, 950, (1901).

² *Z. f. Elektroch.* 10, 13, (1904); *Electrochem. Ind.* 2, 67, (1904).

place is covered with a glass dielectric. Air enters at the top, is partly changed to ozone in passing between the walls of the concentric cylinders, and leaves the apparatus from below. The concentration of the ozone is about 2 grams per cubic meter, which is high enough for all ordinary purposes. The yield varies between 18 and 37 grams per kilowatt hour.³

The Tindal ozonizer is shown in Figure 133. It is in the form of a box, the inner walls of which are water-cooled electrodes and are connected to earth. The other electrodes are metal plates inside the box and insulated from it. Between 40,000 and 50,000 volts are applied to the electrodes.

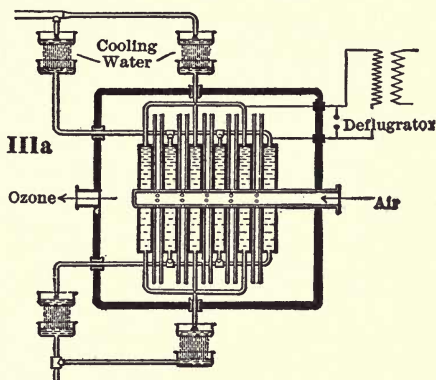
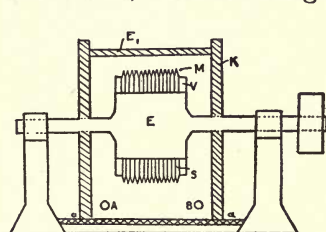

FIG. 134. — The Abraham-Marmier ozonizer

The Abraham-Mar-

mier² apparatus is shown in Figure 134. It consists of a number of cylindrical, parallel, hollow electrodes of about a square meter area, covered with glass and mounted in a box. Water circulates through the electrodes

for cooling, between which about 40,000 volts are applied.



The Otto ozonizer

FIG. 135. — Longitudinal-vertical section

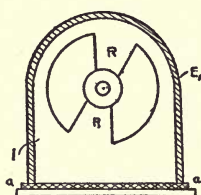

FIG. 136. — Transverse vertical section

It consists of a chamber, *K*, the metal wall, *E*₁, of which forms one electrode. The sheet steel rings, *S*,

The Otto apparatus⁴ is shown in Fig-

³ Askenasy, *Elektrochemie*, 1, 246, (1910).

⁴ *Z. f. Elektroch.* 7, 790, (1901).

sharpened at M , and mounted on an axle on which they rotate, are the other electrode, E_2 . There is no solid dielectric. Air passes in the box at B and comes out at A . While in the box it is ozonized and thoroughly mixed by the rotating electrode.

If an arc were to form between the electrodes, it would be extinguished as the grooves RR in the rotating electrode pass the insulating base of the box, aa . About 25,000 volts are applied to the electrodes, the distance between which may be from 10 to 100 millimeters.

Small ozonizers are now made for sterilizing water where it is drawn for use, as shown in Figure 137.⁵ The transformer and ozonizer are in a metal case, C . P and S are respectively the primary and the secondary of the transformer. The primary is supplied with 100 to 250 volts, which is transformed to 15,000 volts in the secondary. The ozonizer consists of six or more glass plates, G , supported on a grooved bracket at the bottom, and by grooved slips at the sides and top. Three pairs of plates, each plate covered on one side with tin foil, are shown in the sketch. The discharge takes place between two opposite sheets of tin foil one millimeter apart, without an intervening dielectric.

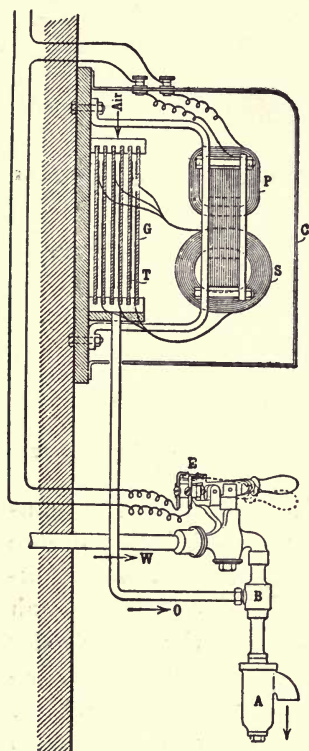

FIG. 137.—Small ozonizer connected to faucet

The air enters the space between the plates at the top and sides, and is sucked down through the opening at the bottom of the ozonizer by the action of the water at B . The water carries the ozone to A , where mixture and sterilization take place. The current in the transformer is of course turned on only when water is drawn.

⁵ Electrochem. and Met. Ind. 6, 304, (1908)

APPENDIX

TABLE OF ATOMIC WEIGHTS

O = 16.00

	(1910) ¹		(1910)
Aluminum Al	27.1	Helium He	4.0
Antimony Sb	120.2	Hydrogen H	1.008
Argon A	39.9	Indium In	114.8
Arsenic As	74.96	Iodine I	126.92
Barium Ba	137.37	Iridium Ir	193.1
Bismuth Bi	208.0	Iron Fe	55.85
Boron B	11.0	Krypton Kr	83.0
Bromine Br	79.92	Lanthanum La	139.0
Cadmium Cd	112.40	Lead Pb	207.10
Cæsium Cs	132.81	Lithium Li	7.00
Calcium Ca	40.09	Lutecium Lu	174.0
Carbon C	12.00	Magnesium Mg	24.32
Cerium Ce	140.25	Manganese Mn	54.93
Chlorine Cl	35.46	Mercury Hg	200.0
Chromium Cr	52.0	Molybdenum Mo	96.0
Cobalt Co	58.97	Neodymium Nd	144.3
Columbium Cb	93.5	Neon Ne	20.
Copper Cu	63.57	Nickel Ni	58.68
Dysprosium Dy	162.5	Nitrogen N	14.01
Erbium Er	167.4	Osmium Os	190.9
Europium Eu	152.0	Oxygen O	16.00
Fluorine Fl	19.0	Palladium Pd	106.7
Gadolinium Gd	157.3	Phosphorus P	31.0
Gallium Ga	69.9	Platinum Pt	195.0
Germanium Ge	72.5	Potassium K	39.10
Glucinum Gl	9.1	Praseodymium Pr	140.6
Gold Au	197.2	Radium Rd	226.4

¹ International Committee on Atomic Weights, J. Am. Chem. Soc. **32**, 3, (1910).

TABLE OF ATOMIC WEIGHTS— *Continued*

	(1910)		(1910)
Rhodium Rh	102.9	Thallium Tl	204.0
Rubidium Rb	85.45	Thorium Th	232.42
Ruthenium Ru	101.7	Thulium Tm	168.5
Samarium Sm	150.4	Tin Sn	119.0
Scandium Sc	44.1	Titanium Ti	48.1
Selenium Se	79.2	Tungsten W	184.0
Silicon Si	28.3	Uranium U	238.5
Silver Ag	107.88	Vanadium V	51.2
Sodium Na	23.00	Xenon Xe	130.7
Strontium Sr	87.62	Ytterbium Yb	172.0
Sulphur S	32.07	Yttrium Y	89.0
Tantalum Ta	181.0	Zinc Zn	65.37
Tellurium Te	127.5	Zirconium Zr	90.6
Terbium Tb	159.2		

TABLE OF ELECTROCHEMICAL EQUIVALENTS OF THE MORE IMPORTANT ELEMENTS¹

	VALENCE	MILLIGRAMS DEPOSITED BY 1 AMPERE IN 1 SECOND	GRAMS DEPOSITED BY 1 AMPERE IN 1 HOUR
Aluminum Al	3	0.0935	0.3366
Antimony Sb	3	0.4152	1.495
Arsenic As	3	0.2589	0.9319
Barium Ba	2	0.7115	0.1976
Bismuth Bi	4	0.5387	1.939
Bromine Br	1	0.8279	2.981
Cadmium Cd	2	0.5821	2.095
Calcium Ca	2	0.2077	0.7476
Cerium Ce	3	0.4843	1.744
Chlorine Cl	1	0.3673	1.322
Chromium Cr	2	0.2694	0.9696
“ “ “	3	0.1795	0.6462
Cobalt Co	2	0.3054	1.099
“ “ “	3	0.2036	0.7331
Copper Cu	1	0.6586	2.371

¹ Based on the atomic weights of 1910 and on the value 96,540 for the electrochemical constant.

TABLE OF ELECTROCHEMICAL EQUIVALENTS—*Continued*

	VALENCE	MILLIGRAMS DEPOSITED BY 1 AMPERE IN 1 SECOND	GRAMS DEPOSITED BY 1 AMPERE IN 1 HOUR
Copper Cu	2	0.3293	1.186
Fluorine F1	1	0.1968	0.7086
Gold Au	1	2.043	7.353
“ “	3	0.6810	2.451
Hydrogen H	1	0.01043	0.03758
Iodine I	1	1.313	4.733
Iron Fe	2	0.2894	1.042
“ “	3	0.1929	0.6947
Lead Pb	2	1.073	3.863
Lithium Li	1	0.0725	0.261
Magnesium Mg	2	0.1260	0.4534
Manganese Mn	2	0.2845	1.024
“ “	3	0.1897	0.6827
Mercury Hg	1	2.071	7.457
Nickel Ni	2	0.3039	1.095
“ “	3	0.2026	0.7290
Oxygen O	2	0.08287	0.2984
Potassium K	1	0.4051	1.458
Silver Ag	1	1.118	4.025
Sodium Na	1	0.2382	0.8576
Tin Sn	4	0.3082	1.109
Titanium Ti	4	0.1251	0.4504
Zinc Zn	2	0.3386	1.219

NUMERICAL RELATION BETWEEN VARIOUS UNITS

ENGLISH AND METRIC MEASURES

NOTE.—Values taken from “Tables of Weights and Measures,” U. S. Coast and Geodetic Survey, 1890.

LENGTH

1 meter = 39.37 inches (legalized ratio for the U. S.)

1 meter = 1.093611 yard

1 meter = 3.280833 feet

1 kilometer = 0.621370 mile

1 inch = 25.40005 millimeters

1 foot = 0.304801 meter

1 yard = 0.914402 meter
 1 mile = 1.609347 kilometer

MASS

1 kilogram = 2.204622 pounds av.
 1 gram = 15.43235639 grains
 1 pound = 0.4535924277 kilograms
 1 ounce av. = 28.34853 grams
 1 ounce troy = 31.10348 grams
 1 metric ton = 1000 kilograms

VOLUME

1 liter = 1.05668 quarts
 1 liter = 0.26417 U. S. gallon
 1 liter = 33.814 U. S. fluid ounces
 1 quart, U. S. = 0.94636 liter
 1 gallon, U. S. = 3.78544 liters
 1 fluid ounce = 0.029573 liter

MECHANICAL EQUIVALENT OF HEAT

1 kilogram-calorie (1 kilogram water raised 1° C. at 15° C.) = 427.3
 kilogrammeters (at sea level, latitude 45°, $g = 980.6$ c.g.s.)
 1 British thermal unit (1 pound of water raised 1° F. at 59° F.) = 778.8
 foot pounds at sea level, latitude 45°
 1 gram-calorie (1 gm. of water raised 1° C. at 15° C.) = 4.190×10^7 ergs
 1 joule = 10^7 ergs
 = 0.2387 gram-calorie

ENERGY

[Winkelmann, Handbuch der Physik, 1, 79, (1908)]

1 kilowatt = 1000 watts
 1 horse power (HP) = 550 foot pounds per second
 = 746 watts
 = 0.746 kilowatt

1 kilowatt = 1.34 horse power

The metric horse power, called in German *Pferdekraft* or *Pferdestärke* (PS)

= 75 kilogrammeters per second
 = 736 watts

Therefore 1 English horse power = 1.014 metric horse power.

LEGAL ELECTRICAL UNITS¹

The legal electrical units in the United States are defined as follows:

(1) The unit of resistance is the international ohm, represented by the resistance offered to a steady current by a column of mercury at 0° C. whose mass is 0.4521 gram, of a constant cross section, and whose length is 106.3 centimeters.

(2) The unit of current is the international ampere and is the equivalent of the unvarying current, which, when passed through a solution of silver nitrate in water, in accordance with standard specifications, deposits silver at the rate of 0.001118 gram per second.

The specifications for the practical application of this definition are the following:

In employing the silver voltameter to measure currents of about 1 ampere, the following arrangements shall be adopted:

The cathode on which the silver is to be deposited shall take the form of a platinum bowl not less than 10 centimeters in diameter and from 4 to 5 centimeters in depth.

The anode shall be a disk or plate of pure silver some 30 square centimeters in area and 2 or 3 millimeters in thickness.

This shall be supported horizontally in the liquid near the top of the solution by a silver rod riveted through its center. To prevent the disintegrated silver which is formed on the anode from falling upon the cathode, the anode shall be wrapped around with pure filter paper, secured at the back by suitable folding.

The liquid shall consist of a neutral solution of pure silver nitrate, containing about 15 parts by weight of the nitrate to 85 parts of water.

The resistance of the voltameter changes somewhat as the current passes. To prevent these changes having too great an effect on the current, some resistance besides that of the voltameter should be inserted in the circuit. The total metallic resistance of the circuit should not be less than 10 ohms.

Method of Making a Measurement. — The platinum bowl is to be washed consecutively with nitric acid, distilled water, and absolute

¹ Bulletin of U. S. Coast and Geodetic Survey, Dec. 27, 1893.

alcohol; it is then to be dried at 160° C., and left to cool in a desiccator. When thoroughly cool it is to be weighed carefully.

It is to be nearly filled with the solution and connected to the rest of the circuit by being placed on a clean insulated copper support to which a binding screw is attached.

The anode is then to be immersed in the solution so as to be well covered by it and supported in that position; the connections to the rest of the circuit are then to be made.

Contact is to be made at the key, noting the time. The current is to be allowed to pass for not less than half an hour, and the time of breaking contact observed.

The solution is now to be removed from the bowl and the deposit washed with distilled water and left to soak for at least six hours. It is then to be rinsed successively with distilled water and absolute alcohol and dried in a hot-air bath at a temperature of about 160° C. After cooling in a desiccator it is to be weighed again. The gain in mass gives the silver deposited.

To find the time average of the current in amperes, this mass, expressed in grams, must be divided by the number of seconds during which the current has passed and by 0.001118.

In determining the constant of an instrument by this method the current should be kept as nearly uniform as possible and the readings of the instrument observed at frequent intervals of time. These observations give a curve from which the reading corresponding to the mean current (time average of the current) can be found. The current, as calculated from the voltameter results, corresponds to this reading.

The current used in this experiment must be obtained from a battery and not from a dynamo, especially when the instrument to be calibrated is an electro-dynamometer.

(3) The unit of electromotive force is the international volt, which is the electromotive force that, steadily applied to a conductor whose resistance is one international ohm, will produce a current of an international ampere, and is practically equivalent to $\frac{1}{1.434}$ of the electromotive force of a Clark cell, at 15° C., when prepared according to the standard specifications.¹

(4) The unit of quantity is the international coulomb, which is the quantity of electricity transferred by a current of one international ampere in one second.

¹ See Bulletin of U. S. Coast and Geodetic Survey, Dec. 27, 1893.

(5) The unit of work is the joule, equal to 10^7 (see under Mech. Equiv. of Heat) ergs, and is practically equivalent to the energy expended in one second by an international ampere in an international ohm.

(6) The unit of power is the watt, and is practically equivalent to the work done at the rate of one joule per second.

NAME INDEX

- ABRAHAM and Marmier, 313.
 Acheson, 210, 217, 219, 220, 221.
 Adams, 34.
 Addicks, 47, 48, 53, 54.
 Adolph, 104, 105.
 Alexander, 203.
 Ashcroft, 234.
 Askenasy, 229.
- Baekeland, 130.
 Bancroft, 54.
 Becker, 234.
 Behr, 22.
 Behrend, 17.
 Bennie, 252.
 Berthelot, 220.
 Berzelius, 236.
 Betts, 64, 236.
 Bindschedler, 76.
 Birkeland, 279, 282, 287.
 Bjerrum, 15.
 Blount, 208.
 Bodenstein and Katayama, 275.
 Bodländer, 15.
 Bölling, 216.
 Borchers, 57, 75.
 Böttger, 19.
 Bradley, 230, 276.
 Braemer, 289.
 Bredig, 11, 266, 267.
 Brown, 55.
 Brush, 153.
 Bugarsky, 15.
 Bunsen, 6, 143, 228, 236.
 Burgess, 36, 146.
- Cantoni, 107.
 Caro, 266.
 Castner, 131, 233.
 Cavendish, 270.
 Coehn, 73.
 Cohen, 43.
 Colby, 259.
 Collins, 2.
 Colson, 209, 217, 218.
 Conrad, 207.
 Corbin, 125.
 Cowles, 185, 209, 229.
- Cowper-Coles, 41.
 Crocker, 126.
 Cruickshank, 21.
 Cumming, 15.
- Daniell, 143.
 Davy, E., 202.
 Davy, H., 228, 233, 236.
 Despretz, 208, 220.
 Deville, 228.
 Dietzel, 57.
 Dolezalek, 154.
 Donath and Frenzel, 276.
 Dony-Hénault, 78.
- Easterbrooks, 51.
 Edison, 173, 182.
 Edström, 265.
 Elbs, 7, 77, 171.
 Elmore, 40.
 Endruweit, 41.
 Engelhardt, 117, 118, 122, 141.
 Erdmann, 16.
 Erlwein, 64, 266, 268.
 Eschmann, 267.
 Ewell, 311.
 Eyde, 281, 282.
- Faraday, 1.
 Farup, 4.
 Faure, 153.
 Ferranti, 259.
 Finckh, 271, 272.
 Fischer, A., 21, 25, 27, 29.
 Fischer, F., 289, 291.
 FitzGerald, 192, 200, 209, 211, 219, 220,
 224, 262.
 Fodor, 150.
 Foerster, 6, 24, 37, 45, 50, 55, 62, 67, 72,
 78, 79, 81, 82, 85, 88, 91-95, 97, 98,
 101-103, 109, 110, 112, 115, 116, 178,
 181, 183, 266.
 Fraenkel, 267.
 Frank, 266, 268, 287.
 Frazier, 216.
 Fromm, 45, 46.
- Gall and Montlaur, 123.
 Garuti and Pompili, 140.

- Gay-Lussac, 83.
 Gibbs, Walcott, 21, 22.
 Gibbs, W. T., 123.
 Girod, 257.
 Gladstone, 157, 158.
 Glaser, 106.
 Goodwin, H. M., 14, 23.
 Goodwin, J. H., 237.
 Gray, 310.
 Grönwall, 250.
 Grove, 143.
 Günther, 45, 67.
 Guthrie, 11.
 Guthe, 1.
 Gyr, 115, 116.

 Haanel, 242.
 Haas, 120, 122.
 Haber, 36, 38, 55, 74, 206, 225, 271, 273,
 278, 285, 287.
 Haeussermann, 131.
 Hahn, 11.
 Hall, 229.
 Hambuechen, 146.
 Hamilton, 51.
 Hansen, 199.
 Hargreaves and Bird, 126.
 Hasse, 46, 67.
 Heim, 158.
 Heimrod, 2, 3.
 Hering, 187, 192, 198, 261.
 Hermite, 117.
 Herold, 181.
 Hérault, 230, 247, 249, 256.
 Herz, 77.
 Hessberger, 282.
 Hibbard, 252.
 Hoepfner, 44, 47.
 Hofman, 49.
 Holborn, 15.
 Holland, 173, 177.
 Holweg, 274.
 Horry, 206.
 Houston, 204.
 Howles, 276.
 Huber, 276.
 Hudson, 203.
 Hunt, 233.
 Hutton, 229.

 Isenburg, 76.
 Jablochhoff, 150.
 Jacobs, 227.
 Jacoby, H., 266.
 Jacoby, M. H., 39.
 Jacques, 151.
 Jahn, S., 288, 290.
 Jakowkin, 80.

 Jellinek, 272.
 Job, 11.
 Joly, J., 11.
 Jorre, 82, 101; 103.
 Jost, 286.

 Keller, 254.
 Kellner, 118, 121.
 Kennelly, 173, 184, 204.
 Kennicutt, 204.
 Kershaw, 47, 123, 125, 243.
 Kiliani, 46, 49.
 Kistiakowsky, 11.
 Kjellin, 259, 262.
 Koenig, 273, 274.
 Kohlrausch, F., 8, 15.
 Kohlrausch, W., 158.
 Kretschmar, 114.

 Lalande, 144.
 Lampen, 217.
 Langbein, 30, 35.
 Lebedeff, 229.
 Le Blanc, 1, 22, 23, 25, 26, 69, 75, 76, 107,
 109, 159, 161, 267, 272.
 Le Chatelier, 191.
 Leclanché, 143.
 Lederlin, 125.
 Ledingham, 6.
 Leithäuser, 273, 292-311.
 Le Rossignol, 286.
 Lewes, 202, 206, 207.
 Lewis, 15, 74.
 Liebenow, 161, 163.
 Lindblad, 249.
 Lombard, 267.
 Lorenz, 94, 109, 233.
 Lovejoy, 276.
 Luckow, 75.
 Luther, 81.
 Lyon, 251, 252.

 McDonald, 126.
 McDougall, 276.
 Magnus, 52, 54.
 Marchese, 43, 44.
 Marsden, 208.
 Marx, 289.
 Massenez, 291.
 Maynard, 59.
 Metzger, 153.
 Meves, 79.
 Moebius, 59.
 Moissan, 202, 209, 216, 220, 266.
 Monkton, 242.
 Müller, E., 74, 81, 85, 89, 91-94, 97, 108-
 110, 112, 117.
 Müller, F. C. G., 10.
 Mylius, 45, 46.

- Nahnsen, 46.
 Nernst, 1, 71, 74, 148, 271.
 Neumann, 232.
 Nicholson and Carlisle, 6.
 Northrup, 261.
 Nüranen, 272.
 Obach, 141.
 Oeschli, 99.
 Oersted, 228.
 Oettel, 4, 86, 92, 122.
 Olsen, 232.
 Ordway, 146.
 Osaka, 73.
 Ostwald, 13, 150.
 Otto, 314.
 Patterson, 131.
 Pauli, 115.
 Pauling, 283.
 Petavel, 229.
 Pinchon, 242.
 Plannhäuser, 40.
 Planté, 152.
 Priestley, 270.
 Pyne, 231.
 Queneau, 191.
 Rathenau, 237.
 Rayleigh, 276.
 Readman, 227.
 Reichert, 16.
 Reinfeld, 41.
 Richards, H. C., 195.
 Richards, J. W., 123, 132, 204, 222, 277.
 Richards, T. W., 1, 15, 22.
 Richardson, 131.
 Richarz, 7.
 Röchling and Rodenhauser, 262.
 Rostosky, 127.
 Russ, 310.
 Salom, 72.
 Salomon, 16.
 Sand, 81.
 Saunders, 41.
 Scheele, 220.
 Schmidt, 137.
 Schneider, 144.
 Schönbein, 7.
 Schönherr, 282.
 Schoop, 141, 181.
 Schuckert, 119, 122.
 Schützenberger, 209, 217, 218.
 Seidel, 6.
 Senn, 65.
 Seward and von Kügelgen, 238.
 Siemens, 243.
 Siemens Brothers, 141.
 Siemens and Halske, 44, 312.
 Smith, 22.
 Soller, 74.
 Spitzer, 37.
 Sproesser, 96.
 Stadion, 99.
 Stålhane, 249.
 Stassano, 243, 254.
 Steiner, 105.
 Streintz, 160.
 Swan, 41.
 Tafel, 70.
 Taylor, 225.
 Thompson, 51, 202, 203, 232, 267.
 Tindal, 313.
 Tone, 219.
 Townsend, 129.
 Tribe, 157, 158.
 Tscheltzow, 160.
 Tucker, 203, 217, 220.
 Turnbull, 257.
 Ulke, 51, 54, 55.
 Uslar, 64.
 Varley, 146.
 Volta, 143.
 Walker, 117, 121.
 Warburg, 273, 290-311.
 Watson, 153.
 Wehrlin, 94.
 Whiting, J., 133.
 Whiting, S. E., 173, 184.
 Wilke, 267.
 Willson, 202.
 Wilsmore, 14.
 Wöhler, F., 202, 226, 228.
 Wöhler, P., 237.
 Wohlwill, 50, 57, 58, 61, 112.
 Wologdine, 191.
 Zellner, 96.

SUBJECT INDEX

- Alkali hydrate and chlorine; diaphragm process, 101-104; bell process, 104; mercury cathode process, 106; mercury diaphragm process, 107; bell cell, 131; Castner cell, 135; Hargreaves-Bird cell, 127; McDonald cell, 126; Townsend cell, 129; Whiting cell, 133-136.
- Aluminum, first isolated, 228; reduction of oxide by carbon, 229; Hall's process, 229-230; Bradley's process, 230; Héroult's process, 230; furnace for electrolytic production, 231; yield per horse power day, 231; temperature of bath, 231; table of production, 232; electrolytic production as laboratory experiment, 232.
- Alundum, 227; table of production, 228.
- Bell alkali chlorine cell, 131.
- Brass plating, 37.
- Bright dipping bath, 31.
- Bromate, electrolytic production of, 115.
- Bromoform, electrolytic production of, 79.
- Calcium, first isolated, 236; electrolytic production by Rathenau, 237; by Seward and von Kùgelgen, 238; by P. Wöhler, 237.
- Calcium carbide, discovery, 202; heat of formation, 202; equilibrium with carbon monoxide, 202; chemical properties, 203; Willson's original furnace for manufacture of, 204; first furnace at Niagara Falls, 205; Horry furnace, 206; yield per kilowatt day, 207; raw materials for, 207; table of production, 206.
- Calcium cyanamide, discovery of production from carbide, 266; pressure of nitrogen in, 267; chemical behavior, 268; manufacture, 269.
- Carbon, different forms distinguished, 220.
- Carbon bisulphide, electrothermic production, 225.
- Carbon electrodes, thermal and electrical conductivities of, 198-199; porosity, 95-96; as anodes in alkali chloride electrolysis, 95-97, 105.
- Carborundum, first produced, 208; discovery by Acheson, 210; named, 210; furnace at Niagara Falls for production of, 212; reaction of formation, 212; raw materials for, 214; yield per kilowatt hour, 214; table of production, 215; uses, 215; analysis of, 210, 216; temperature of formation and of decomposition, 217; chemical properties, 217.
- Carborundum fire sand, 211.
- Chlorate, production by electrolytic discharge of hypochlorite, 85; current efficiency when so formed, 90; electrolytic production in acid solution, 92; in alkaline solution, 84, 93; current and energy yields, 98; Gall and Montlaur cell for production of, 123; Gibbs cell, 123; Lederlin and Corbin cell, 125.
- Chlorine, chemical action on hydrate, 80-84; electrolytic production, see Alkali Hydrate.
- Chloroform, electrolytic production of, 79.
- Complex salts in electroanalysis, 25, 28.
- Conductivity measurement as method of chemical analysis, 15-16.
- Conductivity, thermal; method of determining for carbon electrodes, 197; table of values for refractories, 191.
- Copper, refining, object of, 47; electrolytic method, 48; composition of anodes, 48, 49; composition of cathodes, 49; composition of slime, 50; composition of fresh electrolyte, 51; of foul electrolyte, 52; behavior of impurities in anodes, 49; circulation of electrolyte, 52; size of tanks, 52-54; multiple and series systems of connections, 53; effect of temperature on power required, 54; voltage per tank, 54; polarization, 54; cost, 54.
- Copper, winning of, 43-45.

- Copper plating, 35.
- Coulometers, silver, 2-4; copper, 4-6; water, 6-11; silver titration, 11-12.
- Diaphragms, construction of, 75.
- Edison storage battery, history and construction, 173-177; table of different sizes, 177; theory of, 178-184; nickel electrode, composition of, 178; potential of, 179; efficiency of charging, 181; iron electrode, potential of, 182; effect of mercury contained, 182; chemical changes in battery, 183; electromotive force of, 184; capacity, 184; efficiency, 184.
- Electric furnace, classification, 186; design, 192, 199, 200; heat loss through walls, 187; through electrodes, 193-198.
- Electrochemical analysis, by potential measurement, 13-15; by conductivity measurement, 15-16; by titration, with a galvanometer as indicator, 17-20; by electrolytic deposition, 20-29; change in potential at cathode during, 24.
- Electrochemical equivalent, 1.
- Electrode voltage, 196.
- Electrolytic bleaching solution, see Hypochlorite.
- Electromotive series, 22.
- Electroplating, 30-34; by contact, 34; by dipping, 34.
- Electrotyping, 39.
- Faraday's laws, 1.
- Fluoride, electrolysis of, 113.
- Foil, metallic, electrolytic production of, 41.
- Galvanometer as indicator in titrations, 17-20.
- Galvanoplasty, 39.
- Gas analysis as a means of determining yield of hypochlorite, 86-87.
- Gold plating, 38.
- Gold refining, 61-64; cyanide process for extracting from ore, 63.
- Graphite, first made artificially, 220; theory of formation, 221; furnace for, 222; table of production, 224; thermal and electrical conductivities of, 198-199; electrodes, see Carbon.
- Hydrogen, electrolytic production of, 137-141; Schmidt cell, 137; Garuti and Pompili cell, 140; Schoop cell, 141; Siemens Brothers and Obach cell, 141.
- Hydrogen electrode, in electroanalysis, 20.
- Hypobromite, 114.
- Hypochlorite, production by action of chlorine on hydrate, 80-84; by electrolysis of alkali chloride solution on smooth platinum electrodes, 84-94; effect of temperature, 88; effect of current density, 89; prevention of reduction by chromate, 89; effect of alkalinity on electrolytic production, 93; effect of temperature on production in alkaline solution, 94; decomposition point of, 109; production with platinized anode, 94; with carbon anode, 95; effect of concentration of chloride solution on yield, 89, 96; maximum concentration attainable, 98; current and energy yields, 98; Hermite cell for electrolytic production of, 117; Kellner cell, 118, 121; Haas and Oettel cell, 120, 122; Schuckert cell, 119, 122.
- Hypoiodite, 115; electrolytic discharge of, 116.
- Iodate, 115, 116.
- Iodoform, electrolytic production of, 77.
- Iron, metallurgy of, 239-242; electrothermic reduction from ores, 242; Stassano's preliminary experiments on, 244; Keller furnace for, 246; Héroult's experiments on, 247-249; furnace of Grönwall, Lindblad, and Stålshane, 249; furnace at Héroult, California, 251.
- Lead refining, 64-67.
- Mercury cathode in electroanalysis, 22.
- Multiple system of connections in metal refining, 53.
- Nickel plating, 34.
- Nickel refining, 55-57; Orford process, 56.
- Nitrogen, fixation of; by carbide, 266; pressure of, in calcium cyanamide, 267; yield of calcium cyanamide per unit of power, 269, 287; by oxidation by electric discharge, discovered, 270; thermal equilibrium in, 271; electrical equilibrium, 274; velocity of oxidation, 272; yield per unit of power, 276, 287; apparatus of Bradley and Lovejoy for, 276, 277; of Birkeland and

- Eyde, 279-282; of Schönherr and Hess-berger, 282-283; of H. and G. Pauling, 283-285; by direct union with hydrogen, 285; equilibrium, 286, 287.
- Nitrolime, 270.
- Overvoltage, in electroanalysis, 24; in lead storage battery, 170; in reduction, 71; in oxidation, 73.
- Oxidation, electrolytic, 73; catalytic effect of anode on, 74; of chromium sulphate, 74; of attackable anodes, 75.
- Oxygen, electrolytic production of, see Hydrogen.
- Ozone, discovery, 288; heat of formation, 288; free energy of, 289; velocity of formation by silent electric discharge, 290; yields by different methods of production, 291; maximum concentration by silent discharge, 294-296; yield per coulomb, for *negative points*, 298-305; effect of temperature, 302; of pressure, 303; of concentration of ozone produced, 303; of water vapor, 303; of current strength; yield per coulomb for *positive points*, 305-308; effect of current strength, 305; of temperature, 305; of concentration of ozone produced, 305; of water vapor, 306; yield with alternating current, 307; yield per kilowatt hour for positive and for negative points, 308; theory of formation, 309; effect of transparency of glass of ozonizer, 310; ozonizer, of Siemens, 292, 309; of Siemens and Halske, 312; of Tindal, 313; of Abraham and Marmier, 313; of Otto, 314.
- Parabolic mirrors, electrolytic production of, 41.
- Perbromate, 115.
- Perchlorate, chemical formation, 84, 98; electrolytic formation, 99; technical cells for, 126.
- Periodate, 117.
- Phosphorus, 226.
- Pinch effect, 261.
- Potassium, electrolytic production of, see Sodium.
- Potential, at liquid-liquid junctions, elimination of, 15.
- Potential measurement as method of analysis, 13.
- Primary battery, defined, 142; Volta's, Smee's, Grove's, Bunsen's, chromic acid cell, Leclanché's, 143; Lande's, 144; Daniell's, 145; dry cells, 146; Jaques's cell, 151; Jablochhoff's cell, 150; ideal carbon cell, 147; free energy of, 148.
- Quicking bath, 38.
- Reduction, electrolytic; defined, 68; reducing power of cathode measured by its potential, 69; pressure of hydrogen corresponding to different potentials, 71; catalytic effect of cathode on, 72; of chromic sulphate, 72; of galena, 72.
- Secondary battery, defined, 142.
- Series system of connection in metal refining, 53.
- Silicon, electrothermic production, 219.
- Siloxicon, 217-219.
- Silundum, 216.
- Silver plating, 38.
- Silver refining, 57; Dietzel process, 57; Moebius process, 59.
- Sodium, production by electrolysis of fused hydrate, 233; Castner cell for, 233; Ashcroft process, 234; uses of, 236; world's production, 235.
- Steel, electrothermic refining of, 252; Stassano's furnace, 254; Keller's, 254; Héroult's, 256; Girod's, 257; Kjellin's, 259; Röchling and Rodenhauser's, 262.
- Storage battery lead, history and construction, 152-157; chloride cell, 154; Gould cell, 156; theory of, 157-172; chemical changes in, 157; change in density of acid on charge and discharge, 158; electromotive force, 160; temperature coefficient, 161; Le Blanc's theory of, 161; Liebenow's theory, 163; charge and discharge curves, 165-167; capacity, 168; current efficiency, 169; self-discharge, 169; sulphating, 171.
- Tubes, electrolytic production of, 40.
- Voltameter, see Coulometer.
- White lead, electrolytic production of, 77.
- Wire, electrolytic production of, 40.
- Zinc, electrolytic winning of, 45; spongy, 45, 46; refining, 67.
- Zinc plating, 33.

THE following pages contain advertisements
of Macmillan books on kindred subjects

MAX LE BLANC'S

Text-Book of Electrochemistry

Cloth, 8vo, \$2.60 net

Translated from the Fourth German Edition by Willis R. Whitney.

Professor Le Blanc's treatment covers electrical conductance, electromotive force, electrolysis, and polarization. He describes solvents that possess power of causing transformation of energy into equivalents. He discusses the theory of "electrolytic dissociation" which prevents the neutralization of positively and negatively charged substances. The book closes with a chapter on storage cells, or the arrangements by which electrical energy can be accumulated and stored as chemical energy.

"The last word to date on the subject of electro-chemistry."—*Education*.

"A reliable and representative statement of modern theory . . . in such form as to make the theory applicable to the needs of the research chemist for industrial ends."—*Electrochemical and Metallurgical Industry*.

"The English is above criticism and the presentation is lucid and comprehensible to the last degree. There is nowhere the slightest chance for misunderstanding the writer's ideas. . . . As a presentation of the fundamental facts and prevalent theories of electrochemistry the work is probably without an equal, certainly without a superior. As prices go the book is much cheaper than usual—an additional recommendation."—*Science*.

FRANK HALL THORP'S

Outlines of Industrial Chemistry

New Edition, fully revised. Cloth, 8vo, \$3.75 net

This book is designed as a text-book for students who have had a good preliminary training in general chemistry, both inorganic and organic, and who desire to become familiar with the processes employed in the manufacture of the more important commercial products. Valuable features are the references to periodicals and the bibliographical lists after each section.

"I feel no hesitation in saying that it is the best book for the purpose intended that it has been my good fortune to examine. It fills a very great need for a compact text-book in technological chemistry, and I am sure its use will be extensive. It reaches the standard of Dr. Thorp's usual excellent work in chemistry."—Professor CHARLES BASKERVILLE, *University of North Carolina*.

PUBLISHED BY

THE MACMILLAN COMPANY

64-66 Fifth Avenue, New York

STANDARD BOOKS ON CHEMISTRY

PUBLISHED BY THE MACMILLAN COMPANY

- ABEGG AND HERZ. **Practical Chemistry: An Experimental Introduction to Laboratory Practice and Qualitative Analysis from a Physicochemical Standpoint.** By R. ABEGG and W. HERZ, of the University of Breslau. Authorized translation by H. B. Calvert, B.Sc. (Vic.), A.I.C. With Three Tables.
12 + 118 pages, 12mo, cl., \$ 1.50 net
- ARRHENIUS. **Immunochemistry.** The Application of the Principles of Physical Chemistry to the Study of the Biological Antibodies. By SVANTE ARRHENIUS.
xi + 309 pages, indexes, 12mo, cl., \$ 1.60 net
- BAILEY. **A Text-Book of Sanitary and Applied Chemistry; or, The Chemistry of Water, Air, and Food.** By E. H. S. BAILEY, Ph.D., Professor of Chemistry, University of Kansas.
20 + 345 pages, 12mo, cl., \$ 1.40 net
- BEEBE AND BUXTON. **Outlines of Physiological Chemistry.** By S. P. BEEBE, Ph.D., Physiological Chemist to the Huntington Fund for Cancer Research, and B. H. BUXTON, M.D., Professor of Experimental Pathology, Cornell Medical College.
195 pages, 12mo, cl., \$ 1.50 net
- BEHRENS. **A Manual of Microchemical Analysis.** By Professor H. BEHRENS, of the Polytechnic School in Delft, Holland. With an Introductory Chapter by Professor JOHN W. JUDD, F.R.S., of the Royal College of Science. With 84 Illustrations Drawn by the Author.
11 + 246 pages, 12mo, cl., \$ 1.50 net (postage 8c.)
- BLOUNT. **Practical Electro-Chemistry.** By BERTRAM BLOUNT, F.I.C., F.C.S., Assoc. Inst. C. E., Consulting Chemist to the Crown Agents for the Colonies. Second Impression.
11 + 373 pages, cl., \$ 3.25 net
- COHNHEIM. **Chemistry of the Proteids.** By Dr. COHNHEIM. Prepared from the Second German Edition by Dr. Gustav Mann, Author of "Physiological Histology."
8 + 600 pages, 8vo, \$ 3.75 net
- COMEY. **A Dictionary of Chemical Solubilities, Inorganic.** By ARTHUR MES-SINGER COMEY, Ph.D., formerly Professor of Chemistry, Tufts College.
20 + 515 pages, 8vo, cl., \$ 5.00 net
- FLEISCHER. **A System of Volumetric Analysis.** By Dr. EMIL FLEISCHER. Translated, with Notes and Additions, from the Second German Edition, by M. M. Pattison Muir, F.R.S.E., Assistant Lecturer on Chemistry, The Owens College, Manchester.
19 + 274 pages, 12mo, il., cl., \$ 2.00 net
- GATTERMANN. **The Practical Methods of Organic Chemistry.** By LUDWIG GATTERMANN, Ph.D., Professor in the University of Freiburg. Authorized Translation by William B. Schober, Ph.D., Instructor in Lehigh University. Second American from Fourth German Edition.
15 + 359 pages, 12mo, il., cl., \$ 1.60 net

STANDARD BOOKS ON CHEMISTRY — *Continued*

- LUPTON. **Chemical Arithmetic.** With Twelve Hundred Examples. By SYDNEY LUPTON, F.C.S.
12 + 171 pages, 16mo, cl., \$1.10 net
- MENSCHUTKIN. **Analytical Chemistry.** By N. MENSCHUTKIN, Professor in the University of St. Petersburg. Translated from the Third German Edition, under the Supervision of the Author, by James Locke.
12 + 512 pages, 8vo, cl., \$4.00 net
- MEYER. **History of Chemistry from the Earliest Times to the Present Day.** By ERNEST VON MEYER, Ph.D. Translated by George MacGowan, Ph.D.
8vo, cl., \$4.50 net
- MILLER. **The Calculations of Analytical Chemistry.** By EDMUND H. MILLER, Ph.D., Professor of Analytical Chemistry in Columbia University. Third Edition. Revised and Enlarged.
10 + 201 pages, 8vo, cl., \$1.50 net
- MORGAN. **Qualitative Analysis as a Laboratory Basis for the Study of General Inorganic Chemistry.** By WILLIAM CONGER MORGAN, Ph.D. (Yale), Assistant Professor of Chemistry in the University of California. (c.)
14 + 315 pages, 8vo, il., cl., \$1.90 net
- NERNST. **Theoretical Chemistry from the Standpoint of Avogadro's Rule and Thermodynamics.** By Professor WALTER NERNST, Ph.D., of the University of Göttingen. Revised by the Fourth German Edition.
24 + 771 pages, 8vo, cl., \$3.75 net
- NOYES. **Qualitative Chemical Analysis, with Explanatory Notes.** By ARTHUR A. NOYES, Ph.D., Professor of Theoretical Chemistry in the Massachusetts Institute of Technology. Third Revised and Enlarged Edition.
89 pages, 8vo, cl., \$1.25 net
- OSTWALD. **The Scientific Foundations of Analytical Chemistry Treated in an Elementary Manner.** Translated by George MacGowan, Ph.D.
31 + 799 pages, 8vo, cl., \$2.00 net
- Manual of Physico-Chemical Measurements.** Translated by James Walker, D.Sc., Ph.D.
12 + 255 pages, il., cl., \$2.25 net
- The Principles of Inorganic Chemistry.** Translated with the Author's Sanction by Alexander Findlay, M.A., B.Sc., Ph.D. With 122 Figures in the Text.
27 + 785 pages, 8vo, cl., \$6.00 net
- All by WILHELM OSTWALD, Professor of Chemistry in the University of Leipzig.
- REYCHLER. **Outlines of Physical Chemistry.** By A. REYCHLER, Professor of Chemistry in the University of Brussels. Authorized Translation by John McCrae, Ph.D. (Heid.). With 52 Illustrations. Second Edition.
16 + 268 pages, cl., \$1.00 net

STANDARD BOOKS ON CHEMISTRY — *Continued*

HEMPEL. **Methods of Gas Analysis.** By Dr. WALTHER HEMPEL, Professor of Chemistry in Dresden Technische Hochschule. Translated from the Third German Edition and Considerably Enlarged by L. M. Dennis, Professor of Analytical and Inorganic Chemistry in Cornell University. New Edition.

19 + 490 pages, 12mo, il., cl., \$2.25 net

HERTER. **The Common Bacterial Infections of the Digestive Tract, and the Intoxications Arising from Them.** By C. A. HERTER, M.D., Professor of Pharmacology and Therapeutics in Columbia University, Consulting Physician to the City Hospital, New York.

x + 360 pages, index, 8vo, cl., \$1.50 net; by mail, \$1.62 net

HILLYER. **Laboratory Manual:** Experiments to Illustrate the Elementary Principles of Chemistry. By H. W. HILLYER, Ph.D., Assistant Professor of Organic Chemistry in the University of Wisconsin.

6 + 198 pages, 8vo, cl., 90 cents net

JONES. **The Theory of Electrolytic Dissociation and Some of its Applications.**

12 + 289 pages, 12mo, cl., \$1.60 net

Elements of Physical Chemistry.

11 + 565 pages, 8vo, cl., \$4.00 net

Elements of Inorganic Chemistry.

13 + 343 pages, 8vo, cl., \$1.25 net

Principles of Inorganic Chemistry.

20 + 521 pages, \$3.00 net

All by HARRY C. JONES, Professor of Physical Chemistry in the Johns Hopkins University, Baltimore.

LASSAR-COHN. **A Laboratory Manual of Organic Chemistry.** A Compendium of Laboratory Methods for the Use of Chemists, Physicians, and Pharmacists. By Dr. LASSAR-COHN. Translated from the Second German Edition by Alexander Smith, B.Sc., Ph.D.

19 + 203 pages, 8vo, cl., \$2.25 net

LEBLANC. **The Elements of Electro-Chemistry.** By MAX LEBLANC, Professor of Chemistry in the University of Leipzig. Translated by W. R. Whitney, Instructor of Chemistry in the Massachusetts Institute of Technology, Boston. New Edition, revised from the Third German Edition.

10 + 282 pages, 12mo, cl., \$1.50 net

LENGFELD. **Inorganic Chemical Preparations.** By FELIX LENGFELD, formerly Assistant Professor of Inorganic Chemistry in the University of Chicago.

9 + 55 pages, 12mo, cl., 60 cents net

LEWKOWITSCH. **Chemical Technology and Analysis of Oils, Fats, and Waxes.** Third Edition. Entirely Rewritten and Enlarged. Eighty-eight Illustrations and Numerous Tables. Two Volumes.

16 + 12 + 1152 pages, 8vo, il., cl., \$12.00 net

LEWKOWITSCH. **Laboratory Companion to Fats and Oils Industries.** By Dr. J. LEWKOWITSCH, M.A., F.I.C., Examiner in Soap Manufacture and in Fats and Oils to the City and Guild of London Institute.

12 + 197 pages, 8vo, cl., \$1.90 net

STANDARD BOOKS ON CHEMISTRY — *Continued*

- ROLFE. **The Polariscope in the Chemical Laboratory.** An Introduction to Polarimetry and its Application. By GEORGE WILLIAM ROLFE, A.M., Instructor in Sugar Analysis in the Massachusetts Institute of Technology.
7 + 320 pages, 12mo, il., cl., \$1.90 net
- ROSCOE AND SCHORLEMMER. **A Treatise on Chemistry.** By SIR HENRY E. ROSCOE and C. SCHORLEMMER, F.R.S. Vol. I—The Non-Metallic Elements. New Edition. Completely Revised by Sir H. Roscoe, Assisted by Drs. Colman and Harden.
12 + 931 pages, 8vo, cl., \$5.00 net
- SCHNABEL. **Handbook of Metallurgy.** By Dr. CARL SCHNABEL, Konigl. Preuss. Bergrath Professor of Metallurgy. Translated by Henry Louis, M.A., A.R.S.M., F.I.C., etc., Professor of Mining at Armstrong College, Newcastle-upon-Tyne. Second Edition. Vol. I—Copper, Lead, Silver, Gold. Illustrated with 715 Figures. (c.)
20 + 1123 pages, 8vo, il., cl., \$6.50 net
- SCHULTZ AND JULIUS. **A Systematic Survey of the Organic Colouring Matters.** Founded on the German of Drs. G. SCHULTZ and P. JULIUS. Second Edition. Revised Throughout and Greatly Enlarged by Arthur G. Green, F.I.C., F.C.S.
10 + 280 pages, imperial 8vo, cl., \$7.00 net
- SHERMAN. **Methods of Organic Analysis.** By HENRY C. SHERMAN, Ph.D., Adjunct Professor of Analytical Chemistry in Columbia University.
245 pages, 8vo, cl., \$1.75 net (postage 14c.)
- TALBOT. **An Introductory Course of Quantitative Chemical Analysis, with Explanatory Notes and Stoichiometrical Problems.** By HENRY P. TALBOT, Ph.D., Professor of Inorganic and Analytical Chemistry in the Massachusetts Institute of Technology.
153 pages, 8vo, cl., \$1.50 net
- TALBOT AND BLANCHARD. **The Electrolytic Dissociation Theory.** With Some of its Applications. An Elementary Treatise for the Use of Students in Chemistry. By Professor H. P. TALBOT and ARTHUR A. BLANCHARD, both of the Massachusetts Institute of Technology.
4 + 84 pages, 8vo, cl., \$1.25 net
- THORP. **Outlines of Industrial Chemistry.** A Text-Book for Students. By FRANK HALL THORP, Ph.D., Assistant Professor of Industrial Chemistry in the Massachusetts Institute of Technology. Second Edition. Revised and Enlarged, and Including a Chapter on Metallurgy by Charles D. Demond, S.B., Testing Engineer of the Anaconda Mining Company.
26 + 618 pages, 8vo, il., cl., \$3.75 net
- WALKER. **Introduction to Physical Chemistry.** By JAMES WALKER, D.Sc., Ph.D., F.R.S., Professor of Chemistry in University College, Dundee. Fourth Edition.
12 + 387 pages, 8vo, cl., \$3.25 net
- YOUNG. **Fractional Distillation.** By SYDNEY YOUNG, D.Sc., F.R.S. With 72 Illustrations.
12 + 284 pages, 12mo, il., cl., \$2.00 net

PUBLISHED BY

THE MACMILLAN COMPANY

64-66 Fifth Avenue, New York

JAMES WALKER'S

Introduction to Physical Chemistry

Fourth Edition, 8vo, \$ 3.25 net

"This volume by Dr. Walker might well be made the basis of a course of lectures, intended to give students who do not mean to specialize in physical chemistry a general idea of the subject, while the same course might be taken with profit as an introductory one by those who expect to go farther in the subject. The author has been very successful along the lines that he has laid down, and his book can be recommended heartily."—*Journal of Physical Chemistry.*

TABLE OF CONTENTS

Units and Standards of Measurement—The Atomic Theory and Atomic Weights—Chemical Equations—The Simple Gas Laws—Specific Heats—The Periodic Law—Solubility—Fusion and Solidification—Vaporisation and Condensation—The Kinetic Theory and Van Der Waal's Equation—The Phase Rule—Thermochemical Change—Variation of Physical Properties in Homologous Series—Relation of Physical Properties to Composition and Constitution—The Properties of Dissolved Substances—Osmotic Pressure and the Gas Laws for Dilute Solutions—Deductions from the Gas Laws for Dilute Solutions—Methods of Molecular Weight Determination—Molecular Complexity—Dimensions of Atoms and Molecules—Electrolytes and Electrolysis—Electrolytic Dissociation—Balanced Actions—Rate of Chemical Transformation—Relative Strength of Acids and of Bases—Equilibrium between Electrolytes—Neutrality and Salt—Hydrolysis—Applications of the Dissociation Theory—Electromotive Force—Thermodynamical Proof—Index.

WILLIAM OSTWALD'S

The Scientific Foundations of Analytical Chemistry

Cloth, 12mo, \$ 2.00 net

Translated with the author's sanction by George M'Gowan.

TABLE OF CONTENTS

- PART I—THEORY. The Recognition of Different Substances—The Separation of Substances—Physical Methods of Separation—Chemical Separation—The Quantitative Determination of Substances.
- PART II—APPLICATIONS. Introduction—The Hydrogen and Hydroxyl Ions—The Metals of the Alkalies—The Metals of the Alkaline Earths—The Metals of the Iron Group—The Metals of the Copper Group—The Metals of the Tin Group—The Non Metals—The Calculation of Analyses.
- APPENDIX—Lecture Experiments.

PUBLISHED BY

THE MACMILLAN COMPANY

64-66 Fifth Avenue, New York

HARRY C. JONES'S

The Elements of Physical Chemistry

Revised Edition, 8vo, \$4.00 net

"This new and enlarged edition of Professor Jones's well-known text-book will be welcomed by teachers and students of physical chemistry. . . . This edition has been extensively revised, contains a large amount of new matter, and is a satisfactory realization of the author's aim, as stated in the preface, to bring the book up to date. The volume has been increased in size by 85 pages, but the space devoted to new material is somewhat greater than this, a result made possible by judicious omissions. Subjects newly or more fully treated include J. J. Thomson's electron theory; radioactivity; the work of Morse, and of Lord Berkeley and E. G. J. Hartley on the direct measurement of osmotic pressure; colloidal suspensions; hydrolytic dissociation; conductivity of fused salts; dissociation in non-aqueous solvents; catalysis; the author's hydrate theory; researches of the author and co-workers on conductivity and viscosity in mixed solvents."—*American Chemical Journal*.

"The brief, but carefully prepared, historical sketches, introducing many of the chapters, as, for instance, the one on 'Chemical Dynamics and Equilibrium,' and the great number of references to original papers form excellent features of the book. The marked enthusiasm with which the author writes as a worker in the field is bound to interest the student in the subject as a living one, with many vital problems yet to be solved."—*Journal of the American Chemical Society*.

PUBLISHED BY

THE MACMILLAN COMPANY

64-66 Fifth Avenue, New York

LOUIS KAHLENBERG'S

Outlines of Chemistry

Illustrated, Cloth, 8vo, \$2.60 net

A text-book for college students by the Professor of Chemistry and Director of the Course in Chemistry in the University of Wisconsin.

"The first five chapters are mainly devoted to experimental work on hydrogen, oxygen, and chlorine as a foundation of fundamental facts and laws for the sixth chapter in which the atomic and molecular theories are presented. After two chapters devoted to ozone, hydrogen peroxide, allotropy, and the halogens, in Chapter IX, acids, bases, and salts, hydrolysis, mass action, and chemical equilibrium are concisely defined on the basis of facts. Chapter XVII includes the elements of thermochemistry; Chapter XX, classification of the elements and the periodic system, and Chapter XXIV, solutions, electrolysis, and electrochemical theories. In this arrangement of the essential parts of chemical theory, and with this mode of treatment, it would seem that the author has kept well within the limits of what the average college student can readily comprehend and assimilate. As stated in the preface, the student becomes a clear logical thinker and he does not look upon the atomic and molecular theories as something arbitrary, metaphysical, and well-nigh incomprehensible; it is also mentioned that in principle this is the method of Bunsen and of many other successful teachers of chemistry. Historical connections are kept sufficiently in view by frequent allusions. The cuts are clear and well made and the subject matter well printed. . . . A critical examination of this work gives the impression, I think, that the author has accomplished his purpose and that he has given us one of the best books and in some respects the best book that has been prepared on this subject."—*Journal of the American Chemical Society*.

PUBLISHED BY

THE MACMILLAN COMPANY

64-66 Fifth Avenue, New York

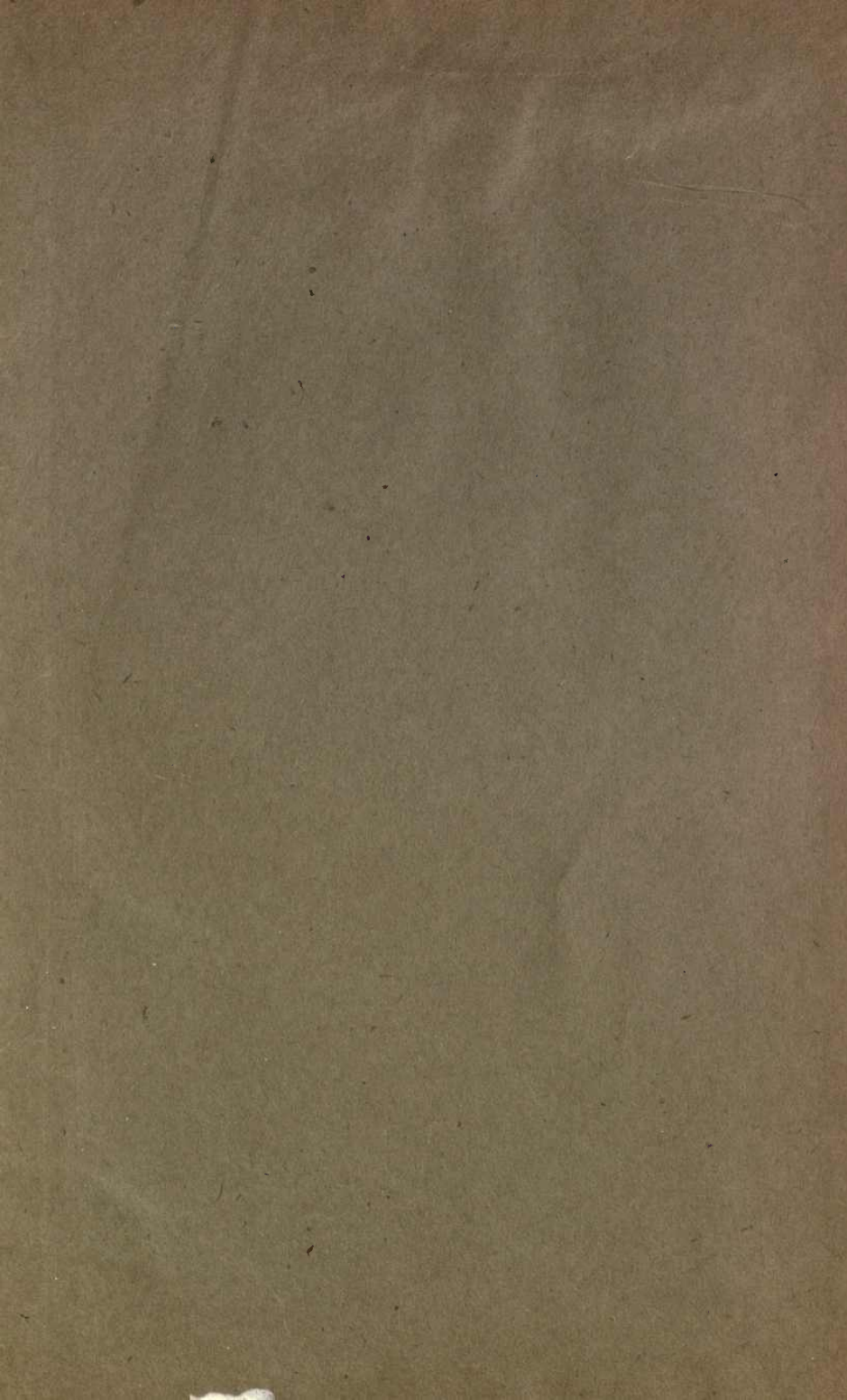

THIS BOOK IS DUE ON THE LAST DATE
STAMPED BELOW

AN INITIAL FINE OF 25 CENTS
WILL BE ASSESSED FOR FAILURE TO RETURN
THIS BOOK ON THE DATE DUE. THE PENALTY
WILL INCREASE TO 50 CENTS ON THE FOURTH
DAY AND TO \$1.00 ON THE SEVENTH DAY
OVERDUE.

MAY 12 1933

OCT 13 1934

DEC 24 1940 M.

FEB 15 1947

120c'58VW

OCT 2 1953 LU

franklin
it. ps. net

TC 10257

387459 TP255
T47

Thompson

UNIVERSITY OF CALIFORNIA LIBRARY

