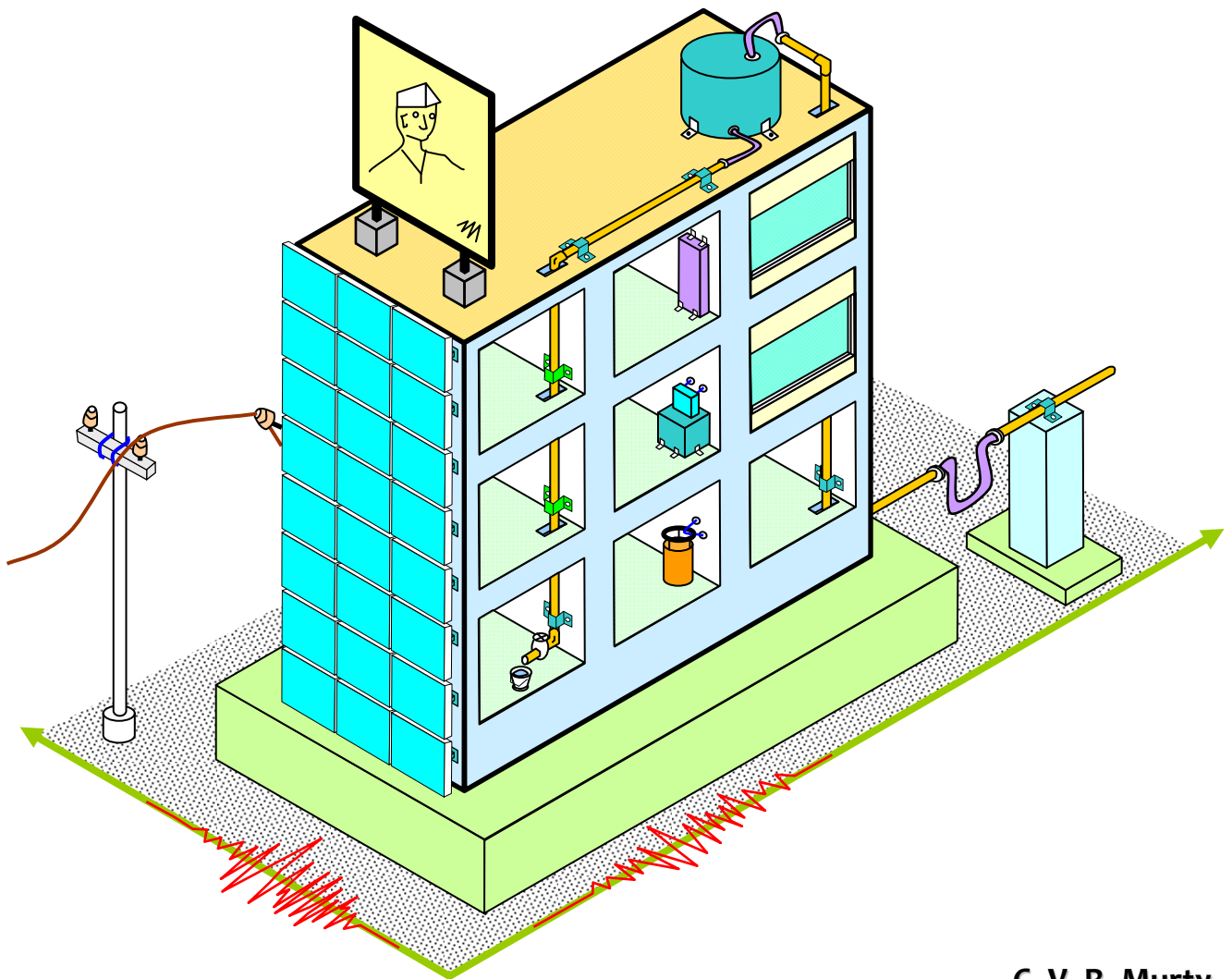


Introduction to

# Earthquake Protection of Non-Structural Elements in Buildings



C. V. R. Murty  
Rupen Goswami  
A. R. Vijayanarayanan  
R. Pradeep Kumar  
Vipul V. Mehta

@EngBook

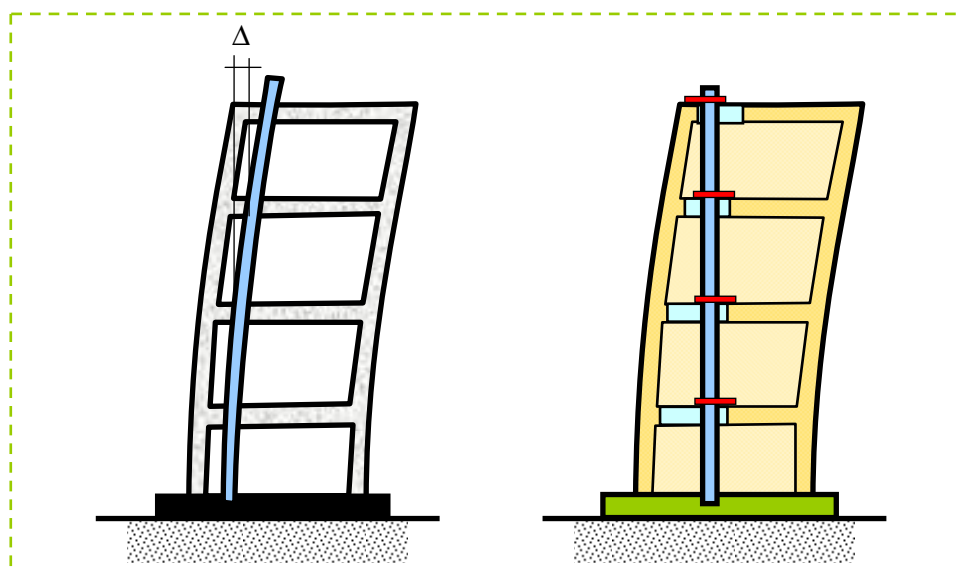
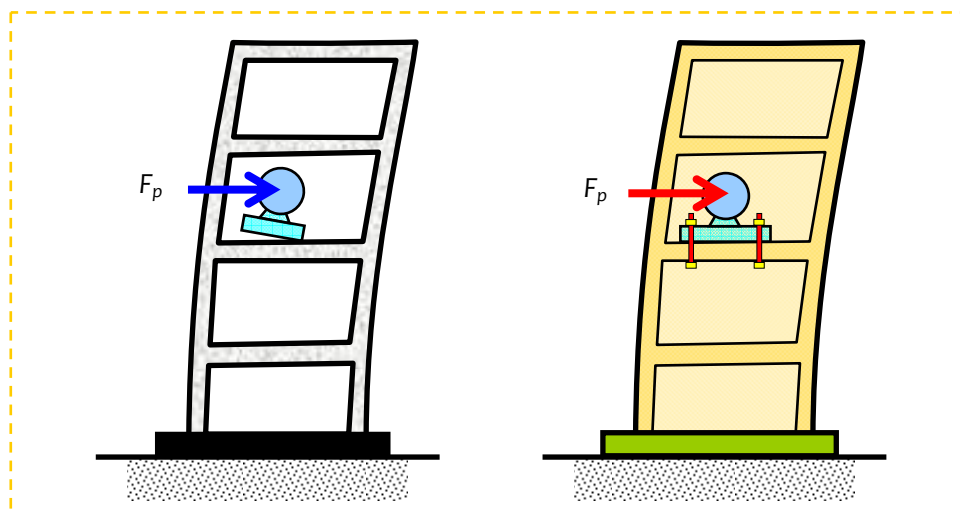


Gujarat State Disaster Management Authority  
Government of Gujarat



Introduction to

# Earthquake Protection of Non-Structural Elements in Buildings



C. V. R. Murty  
Rupen Goswami  
A. R. Vijayanarayanan  
R. Pradeep Kumar  
Vipul V. Mehta



Gujarat State Disaster Management Authority  
Government of Gujarat



## Preface

Countries with advanced seismic safety initiatives have managed to reduce losses due to building collapses, and have made significant progress in protecting *contents, services & utilities*, and *appendages* of buildings, together called *Non-Structural Elements*. But, the situation is not encouraging in many other countries, like India, where earthquake safety of buildings is itself in the nascent stage, not to mention earthquake protection of NSEs. In countries with advanced strategies for earthquake protection of built environment (like USA), the costs of NSEs in hospital structures have already touched the 90% mark of the total building project (construction) cost, excluding that of land. This investment is made consciously in NSEs, backed by strong code provisions for seismic design of NSEs. Likewise, in many other seismic countries (like India), the costs of NSEs in buildings are soaring fast and already touching the 70% mark. But, this investment is happening with NO provisions available for earthquake protection of NSEs in the national standards for seismic design.

This book is meant to introduce the fundamentals of earthquake protection of *Non-Structural Elements* in buildings to first time readers, wishing to get a grip of the basics of the subject. It employs exaggerated shapes of buildings (cartoons) to emphasise deformation sustained by buildings and *NSEs*, to help understand behaviour of buildings and *NSEs* during earthquake shaking and implications of these deformed shapes on seismic design of *NSEs*. The book brings basic research results to readers, and presents under pair of covers, the basics concepts available in international literature related to seismic protection of *NSEs*. Some design provisions are presented as available in international literature for seismic protection of *NSEs*, even though not comprehensive enough.

It is hoped that the book will help draw urgent attention of professional architects and engineers, especially in countries like India, where large investments are being made on *NSEs* in building projects without verifying their earthquake safety. Hence, the target audience of the book includes practicing *Architects* and *MEP Design Engineers*, in addition to teachers and students of architecture and engineering colleges.





## Acknowledgements

The authors are grateful to the *Gujarat State Disaster Management Authority (GSDMA)*, Government of Gujarat, Gandhinagar (Gujarat, India), for readily agreeing to support the preparation of this book; the generous financial grant provided by GSDMA towards this effort is gratefully acknowledged. *Ms. Alpa R. Sheth*, Managing Director, Vakil Mehta Sheth Consulting Engineers Private Limited, Mumbai, and *Seismic Advisor, GSDMA, Gandhinagar, Gujarat*, has provided unstinted support to the project. Her technical inputs have been invaluable at all stages of the project - the proposal review, intermediate feedback during development and technical review at the end. The authors are indebted to her for this proactive role in the development of the book, and thank her sincerely for the same. The authors sincerely thank *Mr. Birju Patel*, Deputy Director, GSDMA, Gandhinagar, for timely action and administrative support from GSDMA side.

The authors extend their appreciation to *Dr. R. Bannerji*, IAS, Chief Executive Officer, GSDMA, *Dr. V. Thiruppugazh*, IAS, Additional Chief Executive Officer, GSDMA and *Mr. S. I. Patel*, Additional Chief Executive Officer, GSDMA for their invaluable inputs and guidance during the course of preparing and finalizing this book.

*Dr. Praveen Malhotra*, StrongMotions Inc., USA, read in detail the first manuscript of this book and offered critical technical comments; the comments helped in recasting a completely different book. The authors are indebted to him for this honest and thought provoking review on the early work. Most sincere gratitude is offered to him for this special contribution towards improving the usefulness of this book. CSI India, New Delhi, provided the nonlinear structural analysis tools, *e.g., SAP2000*, to undertake numerical work for the preparation of this book; this contribution is sincerely acknowledged. *Miss Mahak Gupta* and *Miss Palak Shivhare*, final year B.Tech. students of Department of Civil Engineering, IIT Kanpur, assisted in preparing some solved examples presented in this book; the authors thank them for this important contribution. *Professors Devdas Menon* and *A. Meher Prasad* at IIT Madras provided resources during the early days of the work; the authors are indebted to them for this support. The authors acknowledge with thanks the support offered by various sections of IIT Madras in administering this book writing project. In particular, the authors gratefully acknowledge support offered by *Mrs. S. Kavita*, Project Assistant, Department of Civil Engineering, of the Institute.

The authors remain indebted to their parents and family members for the unconditional support and understanding throughout the development of the book...







# Contents

	<i>page</i>
<i>Preface</i>	<i>iii</i>
<i>Acknowledgements</i>	<i>v</i>
<i>Contents</i>	<i>vii</i>
<i>Symbols</i>	<i>xi</i>
<b>Chapter 1: Introduction to Non-Structural Elements</b>	
1.1 Non-structural Elements	1
1.1.1 Distinction between Structural and Non-structural Elements	2
1.2 Classification of Non-structural Elements	5
1.2.1 Mistaken as Non-structural Elements	6
(a) Unreinforced Masonry Infill Walls	6
(b) Rooftop Water Tanks	9
(c) Elevator Shaft Core made of RC	9
(d) Staircase Waist Slab and Beams	11
1.3 Performance of Non-structural Elements during Past Earthquakes	12
1.3.1 Damages	12
1.3.2 Importance of Securing NSEs	16
1.4 Major Concerns	20
<b>Chapter 2: Conceptual Earthquake Behaviour of NSEs</b>	
2.1 The Two Challenges	23
2.2 The Protection Strategies	26
2.2.1 Force-Sensitive NSEs	27
(a) NSEs anchored only to Horizontal SEs	27
(b) NSEs anchored only to Vertical SEs	27
(c) NSEs anchored to both Horizontal and Vertical SEs	28
2.2.2 Displacement-Sensitive NSEs	28
(a) NSEs supported on two SEs on the same Building, but at Different Elevation	28
(b) NSE Supported on two SEs that shake independently	30
(c) NSE supported on a SE on Building and the Ground	31
2.3 Interaction between SEs and NSEs	31
<b>Chapter 3: Behaviour of NSEs in Earthquake</b>	
3.1 Effects of Earthquake Shaking on Buildings	33
3.1.1 Floor Acceleration Response	35
(a) Concept	35
(b) Obtaining Floor Acceleration Response	36
(c) Factors Influencing Floor acceleration Response	36
(d) Amplification Factors of Floor Accelerations at Different Floors	38
3.1.2 Displacement Response	39
(a) Concept	39
(b) Obtaining Displacement Response and Inter-storey Drift	39
(c) Factors Influencing Displacement Response and Inter-Storey Drifts	40
3.2 Effects of Earthquake Shaking on NSEs	41
3.2.1 Acceleration Effects	41
3.2.2 Displacement Effects	43

	<i>page</i>
3.3 Behaviour of Unanchored Force Sensitive NSEs	45
3.3.1 Behaviour of Single Block	45
(a) Sliding Only	46
(b) Rocking Only	46
(c) Toppling Only	47
3.3.2 Behaviour of TWO Stacked Blocks	48
(a) Initiation of Motion	49
(b) Equation of Motion	49
3.4 Behaviour of Anchored Force-Sensitive NSEs	51
3.5 Behaviour of Displacement-Sensitive NSEs	54
3.5.1 NSEs having Relative Displacement with respect to Ground	54
3.5.2 NSEs having Inter-Storey Relative Displacement	56
3.5.3 NSEs having Relative Displacement between Two Items Shaking Independently	56
3.6 Earthquake Performance of NSEs	58

#### Chapter 4: Performance Expectation from NSEs during Earthquake

4.1 Earthquake Design Philosophy	61
4.1.1 Expected Levels of Performance	63
4.1.2 Levels of Shaking to be considered	68
4.1.3 Safety from Primary and Secondary Hazards	69
4.2 Broad Suggestions for Architects and Engineers	69
4.2.1 Strategies to Protect Force-Sensitive NSEs	71
4.2.2 Strategies to Protect Displacement-Sensitive NSEs	73
4.3 Classification of Protection Strategies	76
(a) Non-Engineered Practice (Common Sense)	76
(b) Pre-Engineered Practice (Prescriptive Approach)	77
(c) Engineered Design Practice (With Calculation)	77

#### Chapter 5: International Code Provisions for Seismic Protection of NSEs

5.1 Basic Provisions for “Engineered Strategy” of Securing NSEs	79
5.1.1 Development of Code Provisions for NSEs	80
(a) Design Lateral Force for NSEs	82
(b) Design Relative Displacement for NSEs	83
5.1.2 IITK-GSDMA Guidelines for Force Design	85
(a) Design Lateral Force for SEs	87
(b) Design Lateral Force for NSEs	88
5.1.3 IITK-GSDMA Guidelines for Displacement Design	91
(a) Design Relative Lateral Displacement for SEs	91
(b) Design Relative Lateral Displacement for NSEs	91
5.2 Earthquake Performance of Code-Designed Connections of NSEs	93
5.3 Limitations in Current Design Procedure	94
5.4 Uncertainties in Understanding Earthquake Behaviour of NSEs	94
5.4.1 Design Lateral Forces for NSEs	94
(a) Design Peak Ground Acceleration $Z$	95
(b) Soil Type & Stratum at the Building Site	95
(c) Floor Acceleration and Displacement along Building Height	95
(d) Response Amplification Factor $a_p$ of NSE	98
(e) Response Reduction Factor $R_p$ of NSE	99
(f) Component Importance Factor $I_p$ of NSE	100
(g) Seismic Weight $W_p$ of NSE	100
(h) Connection of NSEs to SEs	100
(i) Determining the Factors $a_p$ , $R_p$ and $I_p$	100

	<i>page</i>
(j) Type of NSE	100
5.4.2 Design Relative Displacement for NSEs	101
(a) Higher Mode of Oscillation	101
(b) Relative Flexure Stiffness of Beams and Columns	101
(c) Axial Stiffness of Columns	102
(d) Inelastic Action in Buildings	102
(e) Building Irregularities	102
(f) Soil-Structure Interaction	102
(g) Connection between NSEs and Building	103
5.5 Limitation of Analysis Method	103
5.6 Importance of Capturing Nonlinear Behaviour of Building in Design of NSEs	104
5.7 Research Needed	106
5.8 Importance of Seismic Pre-Qualification of NSEs	106

## **Chapter 6: Looking Back to Look Ahead**

6.1 Summary	109
6.2 Closing Comments	111
Reference	113

## **Appendix**

Appendix A	117
Appendix B	145



## Symbols

$a$	Acceleration
$a_{eq}$	Ground acceleration
$a_{eqbx}$	Horizontal acceleration at the base of block
$a_{eqby}$	Vertical acceleration at the base of block
$a_{NSE}$	Component acceleration amplification factor
$a_p$	Component acceleration amplification factor
$b$	Breadth
$C_{NSE,H}$	Net damping
$C_{NSE,V}$	Net damping
$f(\theta)$	Fracture function
$g$	Acceleration due to gravity
$h$	Height
$h_G$	Height up to the centre of mass from the bottom
$h_{sx}$	Storey height used for calculation of inter storey drift
$h_{sx}$	Height of storey below level x of a Building
$h_{sy}$	Height of storey below level y of a Building
$h_x$	Height of building at level x
$h_y$	Height of building at level y
$k$	Elastic stiffness
$k_{NSE,H}$	Net horizontal stiffness
$m$	Seismic mass
$m_{NSE}$	Net mass of NSE
$p$	Frequency parameter
$q$	Influence factor
$r$	Half of diagonal length
$u_f$	Fracture displacement
$x$	Relative deformation
$x$	Height of point of attachment from ground level
$z$	Height of floor under consideration from base of building
$A_{Floor}$	Floor acceleration amplification factor
$A_{Floor,H}$	Horizontal floor acceleration
$A_{Floor,V}$	Vertical floor acceleration
$A_{NSE}$	Horizontal acceleration coefficient
$C$	Coefficient equal to 0.05
$C_a$	Seismic coefficient
$C_p$	Coefficient equal to 3
$D_p$	Estimated inter storey drift
$D_p$	Seismic relative displacement
$F_{eq}$	Earthquake-induced lateral inertia force
$F_p$	Design lateral force for NSE
$F_u$	Ultimate strength
$H$	Height of building
$H$	Lateral base shear force of the building
$I$	Importance factor
$I$	Mass moment of Inertia
$I_o$	Mass moment of inertia of a block
$I_p$	Importance factor of NSE
$K$	Stiffness of the restrainer
$R$	Response Reduction Factor
$R_p$	Component response reduction factor
$S_d/g$	Design acceleration spectrum value

$S_{DS}$	Spectral acceleration for short period
$T$	Fundamental translational natural period of a building
$T_p$	Fundamental natural period of NSE
$V_B$	Design base shear
$W$	Weight
$W_{NSE}$	Weight of NSE
$W_p$	Weight of NSE
$Z$	Seismic Zone Factor
$\alpha$	Integer
$\eta_{Floor}$	Floor response acceleration modification factor
$\nu$	Poisson ratio
$v_g$	Velocity at centre of mass
$\xi$	Damping
$\sigma$	Strength parameter
$\omega$	Sinusoidal excitation of frequency
$\delta_{\xi A}$	Deflection at level x
$\delta_{\xi A}$	Actual Displacement of a building that undergoes nonlinear action
$\delta_{\psi A}$	Deflection at level y
$\mu$	Coefficient of friction
$\theta(\tau)$	Angle between vertical and normal to base
$\theta_1$	First degree of freedom
$\theta_2$	Second degree of freedom
$\theta_\chi$	Block slenderness
$\Delta$	Roof deformation
$\Delta_{aA}$	Allowable inter storey drift
$\Delta_{NSE}$	Displacement of an NSE
$\Delta_p$	Design relative displacement to be accommodated

# Chapter 1

## Introduction to Non-Structural Elements

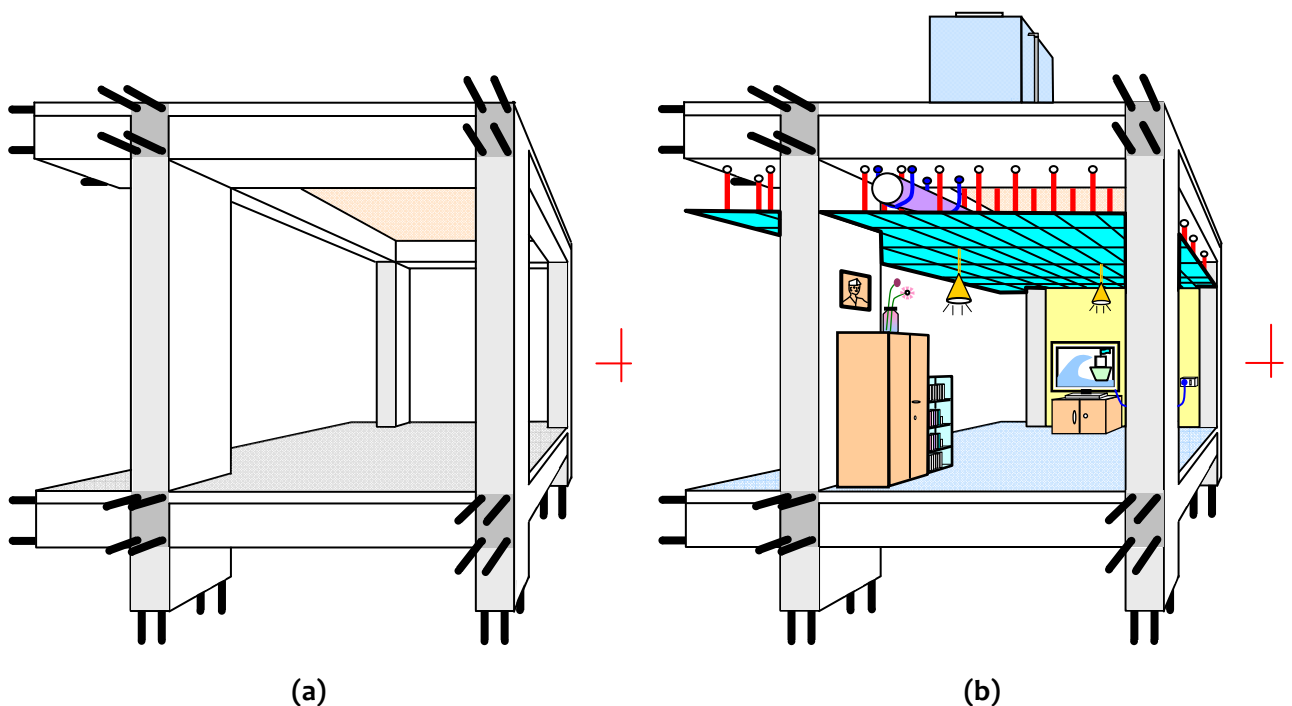
### 1.1 NON-STRUCTURAL ELEMENTS

A building is considered to be *safe*, only when *both* of the following can resist earthquake ground motions occurring at its base without any loss, namely

- (a) *People in the building, and*
- (b) *Contents of buildings, appendages to buildings and services & utilities in the building.*

Here, *safety of people* means no collapse of whole or part of the building that causes danger to life, and *safety of contents of buildings, appendages to buildings and services & utilities* means the contents, appendages, and services & utilities are able to continue to offer the function the way they are expected to *even after the earthquake*. Safety of people in a building depends first on whether or not the building is capable of resisting earthquake shaking, and then on standing upright after the earthquake. Even if the building stands upright after an earthquake, safety of persons may be jeopardized by lack of safety in the other items of the building, namely contents, appendages and services. Significant attention has been drawn to safety of the building during earthquakes, but the latter is not yet in focus, in general. Thus, safety of people can be jeopardized, even if *contents of buildings, appendages to buildings and services & utilities* in buildings are not protected against earthquake shaking. In countries that managed to reduce loss of life by preventing collapse of buildings and structures, losses in recent earthquakes indicate that damage and failure is not eliminated yet in *contents of buildings, appendages to buildings and services & utilities*. Such damages and failures have had major social or economic implications, particularly in critical buildings (*e.g.*, a hospital) and commercial buildings (*e.g.*, a stock exchange).

In the construction of a building, first the *reinforced concrete* or *structural steel* members are made (Figure 1.1a), and then the building is finished with *contents of buildings, appendages to buildings and services & utilities* (Figure 1.1b). In most cases, the items in buildings related to finishing are *rested on* and/or *fastened to* the RC or steel members. The distinction between the two is elaborated in the paragraphs below.



**Figure 1.1:** Item employed in a Building: (a) Bare Structure only, and (b) Finished Structure

### 1.1.1 Distinction between Structural Elements and Non-Structural Elements

When the ground shakes, inertia forces are induced in a building at all locations where mass is present. These inertia forces flow through the building from various mass points through horizontally and vertically oriented structural members to the foundations, and eventually to the soil/ground underneath. Chains of structural members form passages within a building, through which these inertia forces flow from their origin to the soil underneath (Figure 1.2); these chains are called *Load Paths*. Along this load path, members of the building that help carry inertia forces to the ground are called *Structural Elements (SEs)*. For instance, in a moment frame building, the slabs, beams, columns and footings carry all earthquake-induced inertia forces generated in the building down to base of the building, and are the structural elements of the building.

Buildings have multiple load paths, when they have many inter-connected SEs running between mass points in the building and soil points under the foundations. SEs in buildings that constitute the load paths, include

- (a) *Horizontal diaphragms, i.e.,* roof slabs, floor slabs and/or planar trusses in horizontal plane;
- (b) *Vertical elements, i.e.,* planar frames (consisting of beams, columns and/or inclined members interconnected at different levels), vertical walls (RC or masonry), and vertical trusses, all spanning along height in vertical plane;
- (c) *Foundation elements, i.e.,* footing, mat or pile foundations, and soil system; and
- (d) *Connection elements, i.e.,* joinery within (if any) and between above elements.

Buildings perform their best, when load paths in them run *directly* to the foundations *without being interrupted*, in any of horizontal diaphragms, vertical elements, foundation elements or connections. As a direct consequence of uninterrupted flow of inertia force to the foundation of the building, damage occurs only at the designed locations. If lateral load paths are interrupted, damage occurs in elements in which it is not desirable, *e.g.,* if large cut-outs are made at edges of floor diaphragms, damage can accrue in horizontal floor diaphragms. When load paths are interrupted, large loads have to bend to take long detours to reach foundations. Buildings undergo damage at all bends in plan & elevation, which may not be desirable.

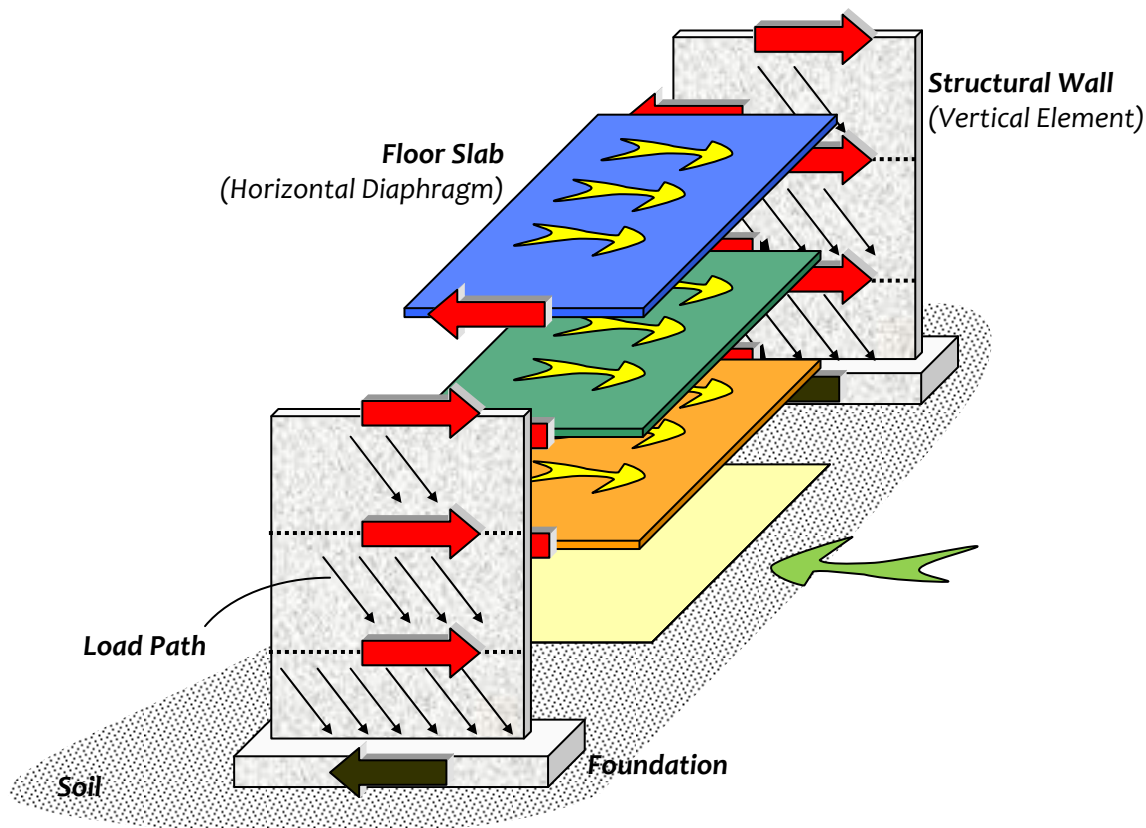


Figure 1.2: SEs create load path in each direction: Allow flow of inertia forces through them



Even though SEs in buildings carry earthquake-induced inertia forces generated in the building down to foundations, there are many items in buildings, such as *contents of buildings*, *appendages to buildings* and *services & utilities*, which are supported by SEs, and whose inertia forces also are carried down to foundations by SEs; such items are called *Non-Structural Elements* (NSEs). NSEs are referred in different documents by different names, like “*appendages*,” “*non-structural components*,” “*building attachments*,” “*architectural, mechanical and electrical elements*,” “*secondary systems*,” “*secondary structural elements*,” and “*secondary structures*.” As the mass of the NSE increases and as the connection between NSE and the SE become stiffer and stronger, the earthquake response of the NSE starts affecting that of the SE to which it is connected, and hence of the whole building.

This book discusses *only* NSEs that are shaken at their base by the oscillating floor of the building on which the NSE is mounted, during earthquake shaking (see *Arrow 0* in Figure 1.3). And, it assumes that the earthquake response of the NSE *in turn* does not significantly influence the earthquake response of the building (see *Arrow 1* in Figure 1.3). Further, it assumes that the shaking at the base of the NSE DOES NOT affect the items inside the NSE (see *Arrow 2* in Figure 1.3) as they are expected to be designed to resist earthquake shaking at their bases.

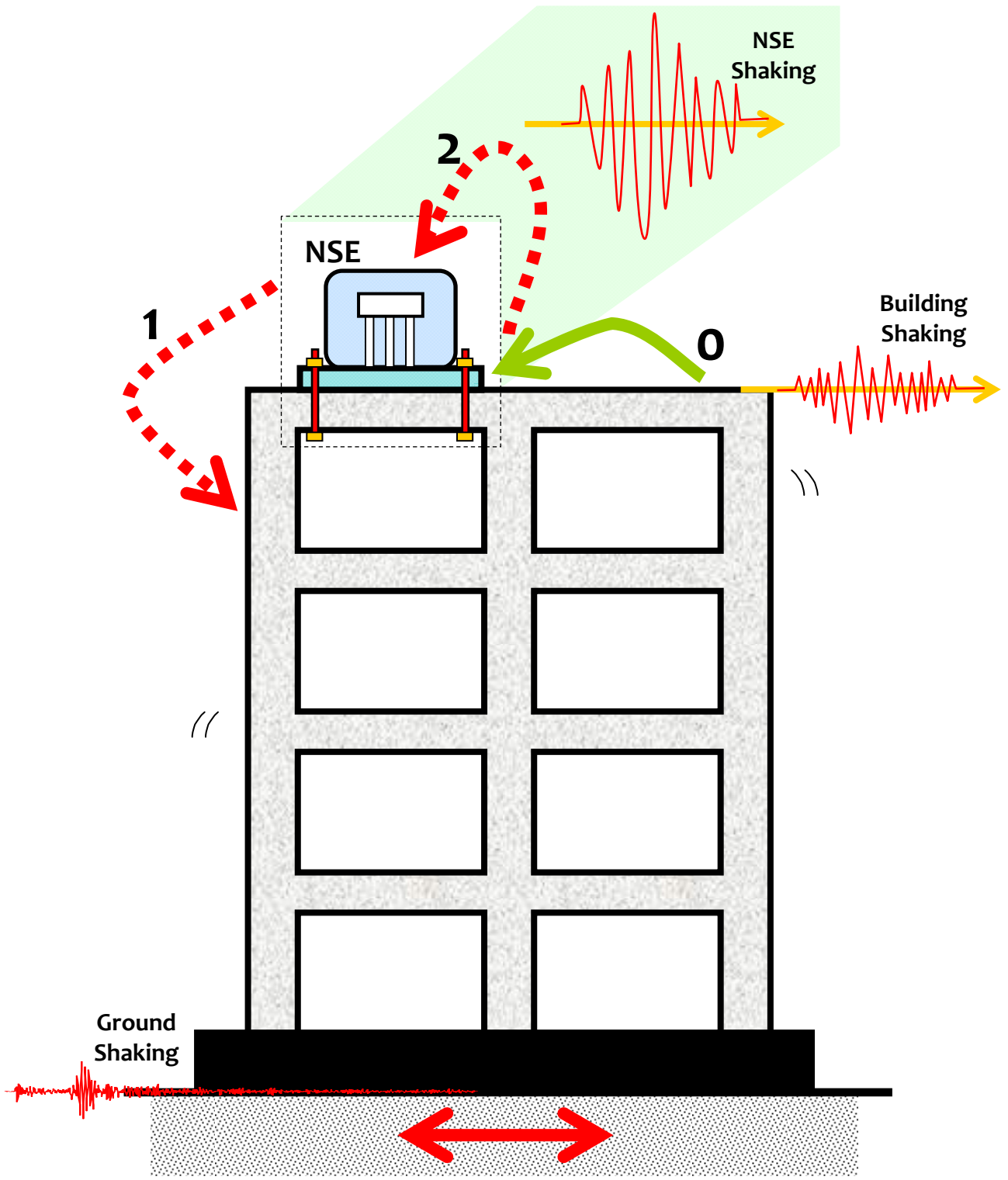
The physical characteristics of NSEs include [Villaverde, 2009]:

- (1) Accelerations imposed on NSEs are higher than those on buildings, primarily due to the amplification of the ground motion along the height of the building;
- (2) NSEs do not possess much ductility to dissipate the energy received during strong shaking. Ductility of NSEs depends largely on their internal design and on design of their connections with SEs;
- (3) Damping associated with NSEs is low;
- (4) NSEs can undergo resonance, when their natural frequencies are close to the fundamental and other dominant frequencies of the building;
- (5) Generally, NSEs are connected at multiple points to the SEs; and
- (6) Responses of NSEs under earthquake shaking are different from those of SEs.

The major differences are listed in Table 1.1 between NSEs and SEs.

**Table 1.1:** *Distinction between Earthquake Performance of SEs and NSEs: a few distinct items*

<i>Item</i>	<i>SEs</i>	<i>NSEs</i>
<i>Shaking at the base</i>	(1) Random, high frequency (2) Non-uniform in long buildings	(1) Predominantly cyclic, low frequency (2) Non-uniform in NSEs with multiple-supports
<i>Damping</i>	(1) High, increases with damage (2) Classical damping gives good approximation	(1) Low (2) Non-classical
<i>Response to shaking at the base</i>	(1) Depends on characteristics of <i>earthquake ground motion</i> (2) Low response amplification	Depends on characteristics of both <i>earthquake ground motion</i> and <i>building</i> High response amplification
<i>Interaction between SEs and NSEs</i>	(1) Seismic responses of <i>SEs</i> affect that of <i>NSEs</i>	Seismic response of <i>NSEs</i> may affect that of <i>SEs</i> and <i>building</i> , depending on <i>mass of NSE</i> and on <i>stiffness and strength of connection between NSEs and SEs</i> . In such cases, responses of <i>NSEs</i> and <i>building</i> should be estimated considering combined <i>building-NSE</i> system
<i>Seismic Demand</i>	Depends on (1) <i>Seismic zone</i> (in which building is located), and (2) <i>Building characteristics</i> (e.g., mass, structural system, ductility)	Depends on location of <i>NSEs</i> within the building, in addition to <i>seismic zone</i> (in which building is located), and <i>building characteristics</i> (e.g., mass, structural system, ductility), and <i>NSE characteristics</i> and connection of <i>NSE</i> to <i>SEs</i> in the building



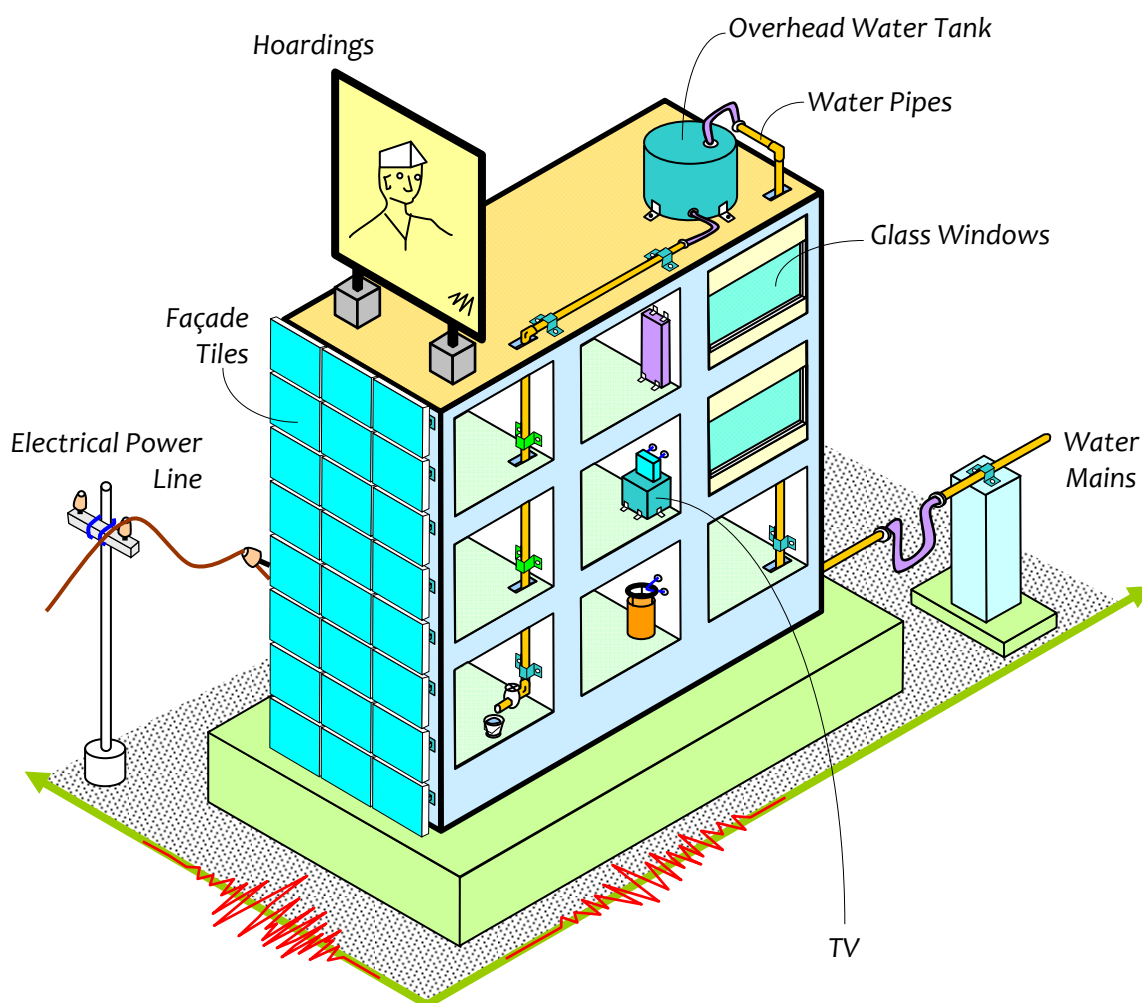
**Figure 1.3:** Various vibrations and interactions between SEs and NSE: There is no damage to NSE and feedback to building by the shaking of the NSE by the building

## 1.2 CLASSIFICATION OF NON-STRUCTURAL ELEMENTS

NSEs can be listed under three groups based on their *use and function*, namely

- (a) *Contents of buildings*: Items required for functionally enabling the use of spaces, such as (i) furniture and minor items, *e.g.*, storage shelves, (ii) facilities and equipment, *e.g.*, refrigerators, washing machines, gas cylinders, TVs, multi-level material stacks, false ceilings, generators and motors, and (iii) door and window panels and frames, large-panel glass panes with frames (as windows or infill walling material), and other partitions within the buildings;
- (b) *Appendages to buildings*: Items projecting out of the buildings or attached to their exterior surfaces, either horizontally or vertically, such as chimneys projecting out from buildings, glass or stone cladding used as façades, parapets, small water tanks rested on top of buildings, sunshades, advertisement hoardings affixed to the vertical face of the building or anchored on top of building, and small communication antennas mounted atop buildings. Thus, some of these are architectural elements, while the rest are functional; and
- (c) *Services and utilities*: Items required for facilitating essential activities in the buildings, such as plumbing lines (*e.g.*, water supply mains, gas pipelines, sewage pipelines, and rainwater drain pipes), electricity cables, and telecommunication wires from outside to inside of building and within the building, air-conditioning ducts, elevators, fire hydrant systems (including water pipes through the buildings).

Some of these NSEs are shown in Figure 1.4. There is significant dependence of NSEs on SEs; well-designed NSEs transfer their earthquake-induced inertia forces to adjoining SEs and accommodate the relative movement imposed by adjoining SEs between their ends.



**Figure 1.4:** *Non-structural elements use load paths available in each direction: NSEs pass on their own inertia forces to SEs and move relative to the SEs, if freedom of movement is provided between NSEs and adjoining SEs*

### 1.2.1 Mistaken as Non-Structural Elements

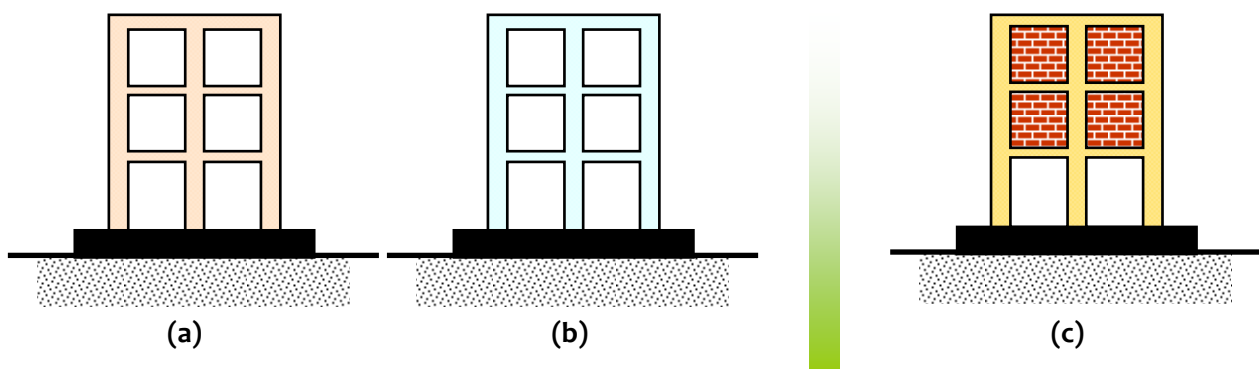
In usual design practice, NSEs are not modeled, because they *are assumed to* not carry any forces by being a part of the load path. However, some elements, assumed to be non-structural, could significantly influence the seismic behaviour of the building by inadvertently participating in the lateral force transfer. It is a practice in India to neglect a number of items in the process of structural design of buildings, *assuming* that these items are “non-structural” elements. But, these items behave *unintentionally* as *structural elements*; they participate in the load path and transfer inertia forces to the ground. Considering the significant contribution to stiffness and strength of such elements (that lie in the load path), it should be made a practice to include them in the analytical model of the building. Thus, the design is made consistent with the conditions of the actual structure. Some of these common SEs that are *assumed* to be NSEs are discussed in this section.

#### (a) Unreinforced Masonry Infill Walls

The most common items assumed by structural designers to be NSEs are unreinforced masonry (URM) infills provided in frame panels of three-dimensional reinforced concrete (RC) *moment resisting frame* (MRF) buildings (Figure 1.5). URM infills are *put in position* after the frame is built. Thus, the gravity loads of the building, namely dead load, superposed dead load and live load, are carried by the frame and not by the URM infills. For this reason, designers *declare* them as NSEs. But, when the building sways under horizontal earthquake shaking, the infills come in the way of the free movement of the frame members, which are SEs. Under such circumstances, they (i) resist the lateral deformation of frame members of the building, (ii) become part of the load path along which earthquake-induced inertia forces generated in the building are transferred to foundation, and (iii) contribute significantly to lateral stiffness and strength of the building. Thus, URM infills may act as NSEs for resisting vertical loads on the MRF building, but are indeed SEs for resisting lateral loads.

As a consequence, earthquake behaviour of buildings with URM infills is completely different from that *assumed* by designers – it can be both *detrimental* and *beneficial* to the safety of the building. When infills are provided uniformly in the building frame, they add to both the strength and stiffness of the MRF building especially in low-rise buildings. But, when provided selectively in the building, they can affect the structural configuration of the building and make it behave poorly. For instance,

- (1) When URM infill walls are provided in all storeys except the ground storey, they make the building stiff and strong in the upper storeys and flexible and weak in the ground storey. Over 400 RC MRF buildings collapsed during the 2001 Bhuj Earthquake due to the flexible and weak ground storey effects (Figure 1.6). This negative effect could have been captured during structural design of the building, if infills were considered in the analysis. Designers should consider URM infills in RC frame buildings as SEs and not as NSEs, include them in structural analysis model, and avoid all unexpected behaviour of buildings.

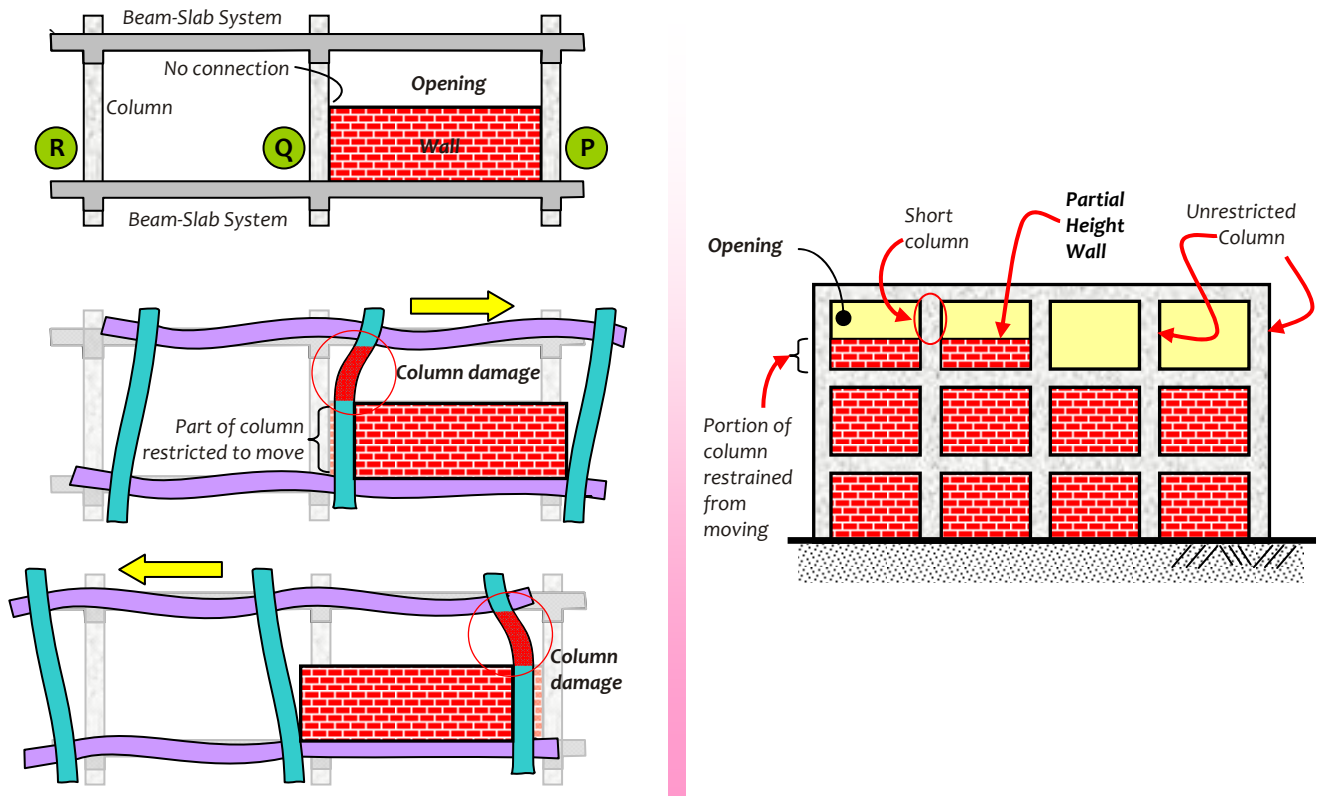


**Figure 1.5:** *Idealization of real buildings:* Analysis and design must bear in mind the physical behaviour of structures during lateral shaking – (a) Analytical Model, (b) Designed Structure, and (c) Actual Structure Constructed



**Figure 1.6:** Collapse of one set of RC frame buildings during 2001 Bhuj (India) earthquake: there is relatively minimal damage in the stiff upper portion, while the lower storey is completely crushed. The almost identical building in the background is completely collapsed.

- (2) Column is restricted from freely shaking in the lateral direction by the URM infill walls, when URM infill walls of partial height are provided adjacent to a column to fit a window over the remaining height. Other columns in the same storey with no adjoining walls do not experience such restriction. Consider earthquake ground movement to the left, when the beam-slab floor system moves horizontally to the right. The floor moves the top ends of all these columns (P, Q, R in Figure 1.7a) by the same horizontal displacement with respect to the floor below. But, the stiff infill walls of partial height restrict horizontal movement of the lower portion of column Q; this column deforms by the full displacement over *only* the remaining height adjacent to the window opening. On the other hand, columns P and R deform over the full height. Since the effective height over which column Q can freely bend is small, it offers more resistance to horizontal motion than columns P and R, and thereby attracts more force than them. But, the columns are not designed to be stronger or have higher shear capacity in keeping with the increased forces that they attract, and thus fail. Now, consider the earthquake ground movement to the right, when the beam-slab floor system moves horizontally to the left. Here, column P is in jeopardy and columns Q and R are not. As a net consequence of earthquake shaking, columns P and Q are damaged due to the presence of the adjoining URM infill walls. This effect, known as *short-column effect*, is severe when opening height is small. The damage is explicit in such columns (Figure 1.7b), even though the assumption is implicit of URM infill walls being considered as non-structural elements.



(a)



(b)

**Figure 1.7:** Short columns effect in RC buildings when partial height walls adjoin columns during 2001 Bhuj (India) earthquake: (a) Effective height of column (over which it can bend) is restricted by adjacent walls, and (b) damage to adjoining columns during earthquake shaking between floor beam and sill of ventilator

### (b) Rooftop Water Tanks

Two types of small capacity water tanks are normally fixed on top of RC buildings, namely high density plastic (HDP) tanks rested directly on roof slab and RC tanks rested on plain concrete pedestals or masonry piers. Of these two, the mass of filled RC tanks is large; they attract high seismic inertia forces. If they are not anchored, they can run loose from top of the masonry piers (Figure 1.8). Unanchored tanks are threat to life; many such tanks dislodged and some collapsed on the ground and adjoining properties during 2001 Bhuj Earthquake. These tanks may be of small capacity, but their connections with the roof slab system should be formally conceived, designed and constructed. Also, such tanks experience far more damage as these behave as cantilevers and cannot mobilize large energy absorption.

### (c) SEs Sometimes “Considered” as NSEs

In RC buildings, when elevator core shafts are made of reinforced concrete, these RC shafts offer lateral stiffness and strength to the overall lateral load resistance of the building. Hence, in the design of multi-storey buildings, the contribution of these RC shafts should be considered. During the 2001 Bhuj earthquake, RC shafts were severely damaged in some reinforced concrete multi-storey buildings with open ground storeys. Discussion with practicing engineers after the 2001 Bhuj (India) earthquake revealed that RC frame buildings were analysed and designed as bare frames; in particular, the contribution of RC elevator shaft cores was neglected. These walls do not always have adequate strength to accommodate the large lateral force attracted by the *whole building*, and hence experienced severe damage. Many RC buildings with open ground storeys collapsed. But, some of these RC buildings, which had RC elevator shaft core, did not collapse; the elevator core shafts were severely damaged but seemed to have helped inadvertently in preventing their collapse (Figure 1.9a). When these elements were not properly connected to the rest of the building frame, the building collapsed but the elevator core did not (Figure 1.9b). The design practice is similar in the rest of India. *These items are undoubtedly SEs, and should be considered* in the analysis and design of buildings.



**Figure 1.8:** Failure of small capacity water tanks atop RC buildings during 2001 Bhuj (India) earthquake: they need to be formally anchored to rooftops, else they can dislodge from the roof



(a)



(b)

**Figure 1.9:** RC building collapsed during 2001 Bhuj (India) earthquake: RC elevator core shafts acted as SEs, and not as NSEs



(d) Staircase Waist Slab and Beams

Most RC buildings built in India have RC staircases built integrally with the structural system of the building. The staircases elements (namely *base slab*, *spine beam* and *cross beams*) act as diagonal braces and attract large lateral forces during earthquake shaking (Figure 1.10). The SEs associated with the staircase usually offer unsymmetrical lateral stiffness and strength to the building. Hence, though the staircase is not considered in structural analysis and design of a building system, it participates in the load path during strong shaking, attracts significant earthquake induced forces, and gets damaged (Figure 1.11). Hence, they are SEs and not NSEs. When SEs connected to the staircase are not designed with adequate stiffness and strength, they fail. This results in a discontinuity of the load path along which inertia forces are transferred to the lower level of the building.

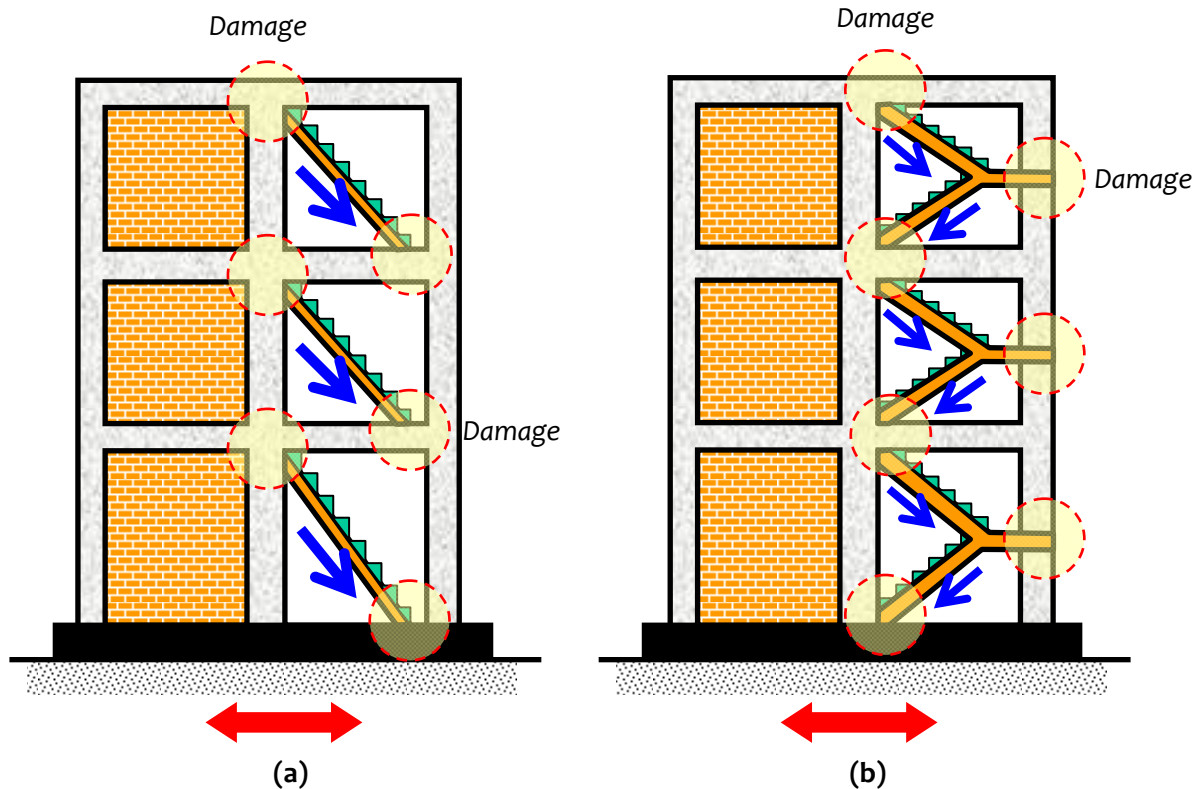


Figure 1.10: Staircase Elements participate in Load Path: (a) Straight flight, and (b) Dog leg staircase



Figure 1.11: Undesirable earthquake performance of elements assumed to be non-structural elements during 1972 Nicaragua Earthquake: Damage to unreinforced masonry infill and floor tiles around stairwell (Photo: The EERI Annotated Slide Collection, 1997)

## 1.3 PERFORMANCE OF NON-STRUCTURAL ELEMENTS DURING PAST EARTHQUAKES

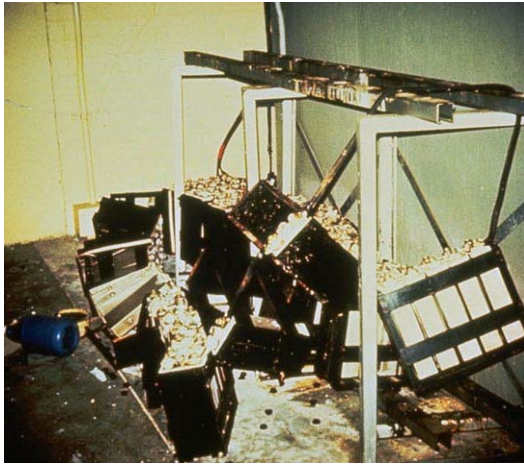
Earthquake shaking poses a threat to safety of SEs as well as of NSEs. Lack of safety of SEs compromises *life of occupants* of such buildings; of course, NSEs are lost in those buildings. Thus, the effort for ensuring earthquake safety of NSEs presumes that SEs are safe under the expected level of earthquake shaking. Only after the building is ensured to be structurally safe and earthquake-resistant, effort should be made to ensure safety and functionality of NSEs. *In normal structures*, damage to NSEs compromises (1) collateral damage to people and other objects/facilities, and (2) damage and loss of functionality of NSE. *In critical and lifelines structures*, functionality of the NSEs is compromised, in addition to the above two aspects. For instance, in a hospital, if oxygen cylinders topple or/and their pipelines to operation theatres and wards are broken, secondary disasters can happen. Also, if the X-ray machine topples during the earthquake, damage-sensitive components inside are rendered useless after the earthquake, its vital function to render most required services after the earthquake is jeopardized, not to mention the direct and indirect human and financial losses incurred as a consequence of this. Thus, earthquake damage or loss of NSEs can lead to (a) injury or loss of life, (b) loss of function of NSE, and (c) direct and indirect financial setback.

As of today, few countries have seismic design provisions to protect NSEs against earthquakes. This is a reflection of the fact that lessons were not learnt necessarily by all communities world-wide from losses incurred in NSEs during past earthquakes. In many countries the losses of life are so overwhelming even today owing to collapses of buildings and structures, that NSEs have not received yet the due attention.

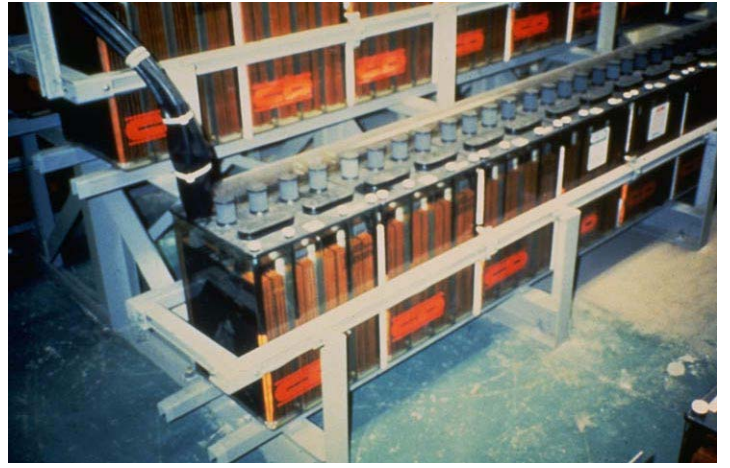
### 1.3.1 Some Damage Types

NSEs that are massive have a tendency to slide and/or topple, if they are unanchored to the vertical or horizontal SEs. For instance, if a wet battery bank is just rested on some supports that are not designed to resist earthquake effects, the batteries can topple, and cause loss of function and even spillage of acid (Figure 1.12a). On the other hand, if the same battery bank is held on supports that are designed to resist the earthquake effects and anchored at the base on horizontal SEs, then its performance is significantly improved during earthquakes (Figure 1.12b)

Some NSEs cannot be held *individually* from toppling, *e.g.*, small items, like *bottles* and *books* on shelves. For instance, when a bookshelf is shaken, the losses can be by toppling of shelf itself (and NSEs) (Figure 1.13), or by toppling of books even though the shelf is in place (Figure 1.14). For such NSEs, a common sense approach is taken to prevent damage or loss during earthquake shaking; a wire rope is tied across the items (like books and bottles) on the supports of the shelves, and the shelves themselves are anchored to the vertical SEs (like structural walls or columns) or horizontal SEs (like slabs or beams) and prevent them from toppling. Such simple mitigation measures adopted in past earthquakes have been successful (Figure 1.15).



(a)



(b)

**Figure 1.12:** Poor earthquake performance of NSEs was avoidable through design during 1971 San Fernando Earthquake: (a) heavy battery bank collapse owing to un-designed supports, and (b) improved performance with formal supports (Photos: The EERI Annotated Slide Collection, 1997)



(a)



(b)

**Figure 1.13:** Poor earthquake performance of NSEs 1987 during 1987 Whittier Narrows Earthquake: (a) Books placed on shelves toppled, and the unanchored shelves also toppled as they were not anchored to the vertical SEs; and (b) bookshelf distorted owing to poor design of the shelf for resisting earthquake effects (Photos: The EERI Annotated Slide Collection, 1997)



(a)



(b)

**Figure 1.14:** Poor earthquake performance of NSEs during (a) 1989 Loma Prieta, California Earthquake and (b) 1994 Northridge Earthquake: objects placed on shelves anchored to the vertical SEs, but not prevented from toppling (Photos: The EERI Annotated Slide Collection, 1997)



(a)



(b)

**Figure 1.15:** Good earthquake performance of NSEs is achievable through simple and innovative, but careful design of the anchors: (a) holding back the bottles on a rack during 1978 Coyote Lake Earthquake, and (b) holding back the heavy book shelves to the wall (Photos: The EERI Annotated Slide Collection, 1997)

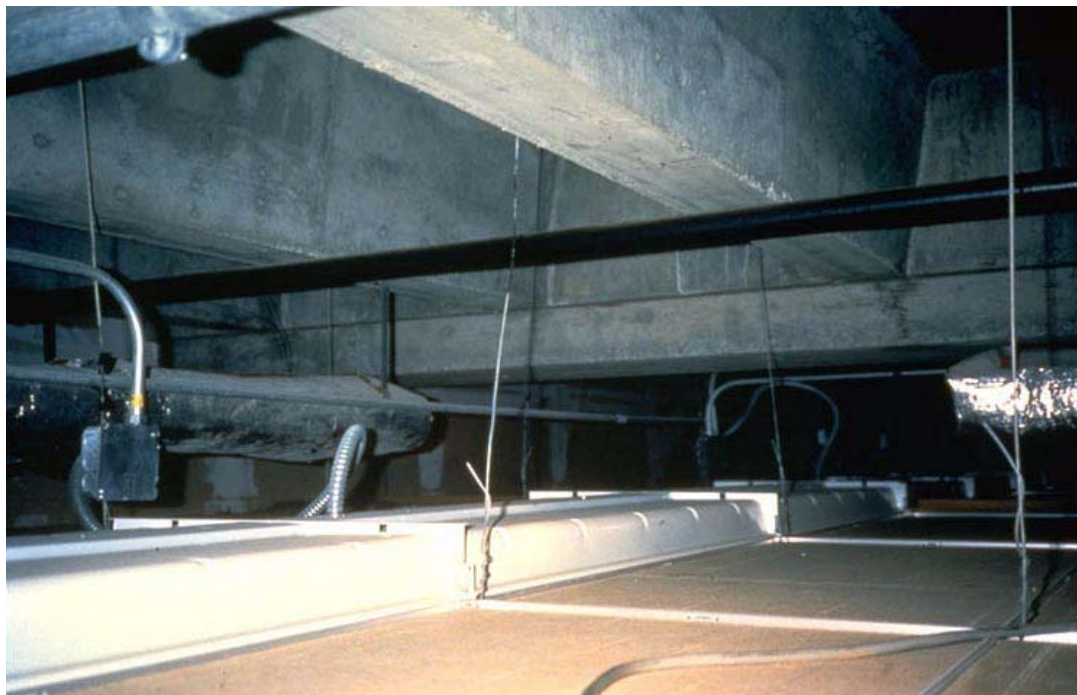
If an NSE (say, light fixtures or false ceiling) is hung from horizontal SEs, it tends to swing like a vertical string pendulum. Under strong *horizontal* earthquake shaking, the lateral swing may be too much, and under strong *vertical* shaking, there is a threat of the NSE being pulled out of the horizontal SEs (namely the *ceiling slab* of the room). This vulnerability of NSEs should be examined during architectural design stage, to avoid threat to life and property (e.g., Figure 1.16). Light fixtures and false ceilings should be held by both horizontal and vertical SEs (Figure 1.17).



(a)

(b)

**Figure 1.16:** Poor earthquake performance of NSEs during (a) 1983 Coalinga Earthquake and (b) 1994 Northridge Earthquake: (a) hanging light fixtures, and (b) collapse of false ceiling (Photos: The EERI Annotated Slide Collection, 1997)



**Figure 1.17:** Poor earthquake performance of NSEs is avoidable through design: false ceiling systems require diagonal brace-like anchors also; just vertical elements alone make the NSE swing horizontally (Photos: The EERI Annotated Slide Collection, 1997)

Vertical projections made of unreinforced masonry (URM) walls are most vulnerable to earthquake shaking (Figure 1.18); they tend to fall in their thin direction, whether they are parapet walls or boundary walls. Collapse of parapet walls from large elevations can cause threat to life. These URM walls need to be anchored formally to the horizontal SEs.

### 1.3.2 Importance of Securing NSEs

Experiences from several past earthquakes in countries with advanced provisions for earthquake safety show that even when the building structure is made earthquake-resistant, there are three negative effects of earthquake behaviour of NSEs, namely *threat to life*, *threat to loss of function*, and *threat to loss of property*. On the basis of these threats, two sets of hazards are perceived, namely

- (a) *Primary Hazard*, when the NSE can get damaged, can impair *its own* function and jeopardize safety of people's lives. For instance, a window glass in the upper elevation of a multi-storey building can break, if it is subjected to large in-plane deformation, fall down to the ground from that elevation, and injure/kill persons walking on the sides of the building. In another instance, toppling of unreinforced masonry parapet wall or chimney of a house can harm life of persons below (Figure 1.19a); and
- (b) *Secondary Hazard*, when the NSE can cause such actions that lead to yet another disaster involving safety of people's lives, building and its contents. For instance, toppling of chemical bottles can lead to spill of chemicals in a laboratory, which, in turn, can cause fires (Figure 1.19b).



(a)



(b)

**Figure 1.18:** Poor earthquake performance of NSEs is avoidable through design: (a) unreinforced masonry parapet collapse during 1980 Italy Earthquake, and (b) unreinforced masonry boundary wall collapse during 1994 Northridge Earthquake (Photos: The EERI Annotated Slide Collection, 1997)



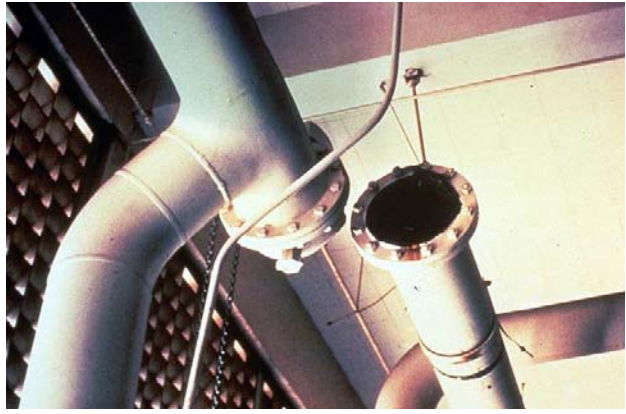
(a)



(b)

**Figure 1.19:** *Earthquake performance of non-structural elements can cause first and second order disasters: (a) toppling of masonry chimneys can cause loss of life of persons below - 1987 Whittier Narrow Earthquake, and (b) chemical spill in a laboratory can cause loss of life - 1971 San Fernando Earthquake (Photos: The EERI Annotated Slide Collection, 1997)*

Loss due to an NSE can be *small* or *substantive* depending on the function it is serving and its cost. For instance, if book shelves of a library are not properly secured, they can get distorted (Figure 1.13) or topple; the former may only dislodge books, but the latter can cause threat to life. This may not seem to be a significant loss of NSE or its function. But, on the other hand, an unreinforced masonry chimney can topple from the roof top and cause threat to life (Figure 1.19b). Similarly, if gas cylinders trip and pipelines are pulled apart (Figure 1.20a), or electric wires are stretched out of the toppled control panels (Figure 1.20b), then they can cause secondary disaster, like fire and/or deaths due to asphyxiation. A similar situation of a second order crisis arises when chemical spill happens in a laboratory. Further, if the sprinkler system fails in a hospital, the use of the hospital may be jeopardized after an earthquake (Figure 1.21a). On a contrasting note, if the holy scriptures in a monastery are damaged due to collapse of the shelves (Figure 1.21b), estimating the loss will be difficult, because in that case, the heritage of the country may be lost.

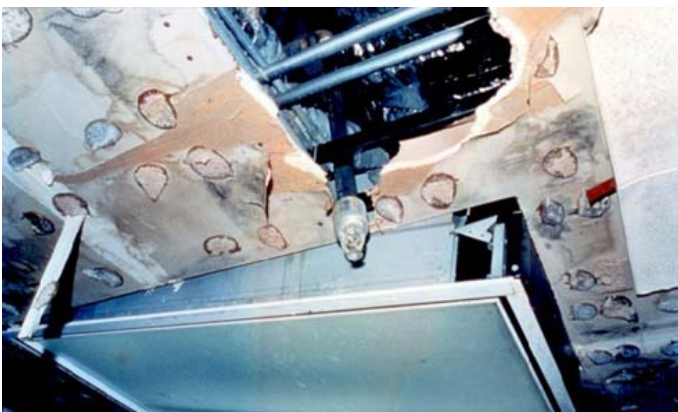


(a)



(b)

**Figure 1.20:** Earthquake performance of non-structural elements: (a) toppling of gas cylinders during 1971 San Fernando Earthquake, and (b) pullout of electrical control panel (Photos: The EERI Annotated Slide Collection, 1997)



(a)



(b)

**Figure 1.21:** Earthquake performance of non-structural elements: (a) failure of sprinkler system during 1994 Northridge Earthquake (Photos: The EERI Annotated Slide Collection, 1997) and (b) toppling of shelves holding Holy Scriptures of Buddhist religion during 2011 Sikkim Earthquake



Whether the NSE topples or pulls apart, direct and indirect losses can be significant. Today, already about 60-70% of the total cost of construction in new buildings being built in urban India is of NSEs, and the rest of the SEs. Since NSEs account for significant part of the total cost of most buildings, it is recognized in countries prone to seismic hazard, that good earthquake performance of NSEs also is extremely important.

Securing of NSEs needs to be carried out together by *all stakeholders* involved in the building project, including (a) Tenants, (b) Owners, (c) Architect and Designers, (d) Contractors, (e) Manufacturers, (f) Building Officials and (g) Researchers. Public awareness on possible threats to life and potential economic loss that could be incurred due to failure of NSEs may strengthen the need for securing NSEs. Public awareness can be brought about by educating the common man (especially tenants and owners) on seismic protection and disaster mitigation. With prior understanding of the importance of securing NSEs, clients (owners) may now warrant architects and designers to incorporate safety features to secure NSEs. Consequently, architects and designers are required to be familiar with the current design and detailing procedures to secure NSEs. Further, designer may choose to use only those NSEs that are tested to possess capability to resist earthquake shaking over those that are not. This will improve the survivability of NSEs during strong earthquake shaking, and *in turn* initiate manufacturers to test and sell only quality products. This seismic pre-qualification of NSEs leads to improved understanding of the behaviour of NSEs subjected to earthquake-induced shaking. In time ahead, there would be increased pressure on manufacturers of NSEs to ensure earthquake safety.

Clearly, there is immense scope to improve significantly the design provisions for securing NSEs. Strict building regulations are required to ensure proper implementation of the design by contractors, and stringent building regulation enforcement regime is required to ensure proper compliance by officials and owners. In all, it is the primary responsibility of *all stakeholders* involved to ensure that both the building and the NSEs are safe against the effects of earthquake shaking, and thereby to ensure safety of life and property.

Inherent problems in the effort of securing NSEs [ATC 29, 1990; ATC 29-1, 1998, ATC 29-2, 2003] include:

- (a) *Lack of public awareness amongst owners*: Interest of the building owners is inversely proportional to time since the last earthquake;
- (b) *Lack of awareness amongst professionals*: Often architects and structural designers are unaware of the attention to be paid to NSEs in the building, but spend lavishly on these NSEs. Thus, it is not guaranteed that this investment on NSEs is safe, because the NSEs are not protected against damage during earthquake shaking;
- (c) *Lack of legal framework*: Regulatory systems are not in place yet in many places of the world to ensure safety of even buildings, not to mention about NSEs. And, developers are getting away with being miserly about spending any money on ensuring safety of buildings and NSEs;
- (d) *Lack of champions*: Currently, no one professional group (civil engineers or architects) is taking responsibility to further the cause of NSE safety; and
- (e) *Inadequate literature*: There is limited continuing education material for practising architects and design engineers to improve understanding of earthquake safety of NSEs.

As a direct consequence, losses due to failure of NSEs are on the rise in urban buildings. Learning how to secure NSEs also takes time, and hence should be started immediately. Experiences from countries with advanced practices of earthquake safety suggest that even though loss of life has been minimized due to structural collapses, the economic setback due to lack of safety of NSEs is still large.

## 1.4 MAJOR CONCERNS

The share of cost of NSEs has been rising out of the building construction cost of the project over the last four decades in India. Table 1.4 presents details of special features of buildings built in different eras over the last four decades. The broad evolution of costs is depicted in Figure 1.22. From a meager ~5% in the 1970s, cost of NSEs rose to a dominant ~70% in the 2000s with high expectations of functional performance of buildings and increased maintenance costs. A saturating trend is expected in NSE costs over the next decade, because changes in the building performance are expected to be only nominal and that too only in select buildings. Also, many varieties of NSEs (that are used in current day buildings) are not tested to demonstrate that they are capable of resisting strong earthquake shaking. Manufacturers may spend more to demonstrate that NSEs have enough capacity to maintain their integrity under seismic action. In turn, this may raise the cost of NSEs.

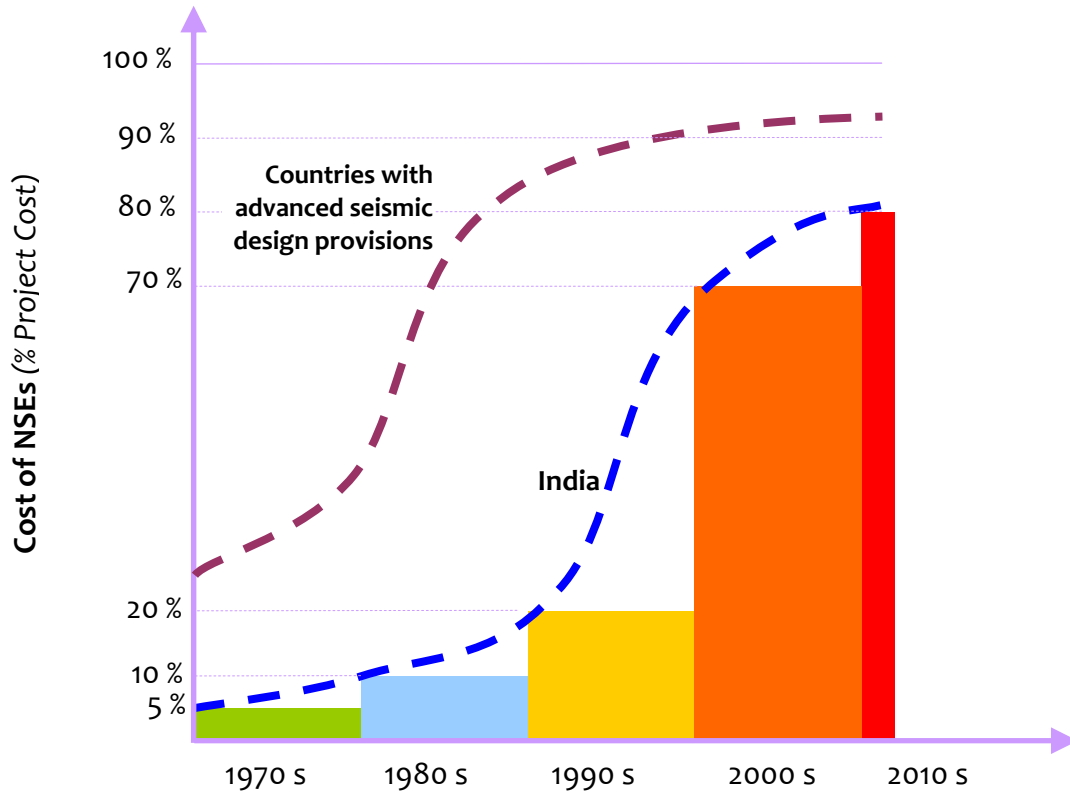
In USA, the average economic loss due to earthquake-related failure of NSEs alone is estimated to be around US\$2-0-4.5 billion per year over the last three decades [ATC 69, 2008; Kircher, 2003]. Figure 1.23 shows summary of studies undertaken following 1994 Northridge earthquake in USA and 1995 Hyogo-ken Nanbu earthquake in Japan, in terms of cost share of different items in buildings in USA and Japan [Kanda and Hirakawa, 1997; Taghavi and Miranda, 2002; and Takahashi and Shiohara, 2004]. Economic losses are as shown in Table 1.5 due to failure of NSEs during different earthquakes.

**Table 1.4:** Evolution of NSEs used in building over the last four decades in INDIA

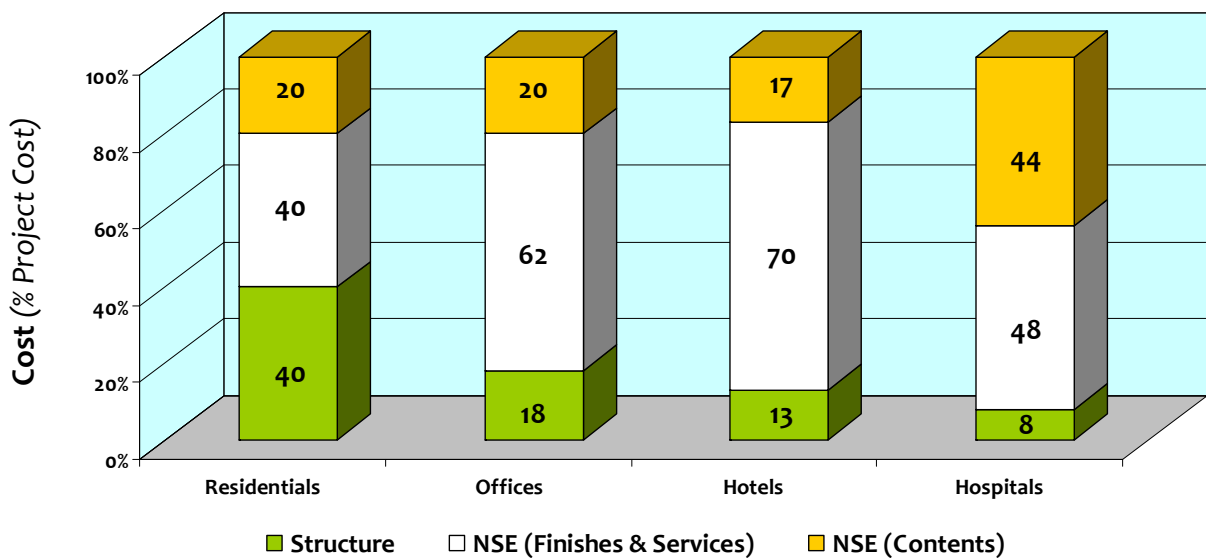
<i>Era</i>	<i>Dominant Building Type</i>	<i>Overview of NSE Features</i>	<i>NSE Highlights</i>
1960-1970s	Masonry buildings	Nothing special	Cement mortar plastering of walls, batted electrical wiring, ceramic plumbing lines
1970-1980s	RC buildings	Primary	+ Wall cements, advanced paints, rooftop water tanks, concealed electrical wiring
1980-1990s	Multi-storey RC buildings	Additional	+ Wall putties and Plaster of Paris coating on walls, elevators, window ACs, PVC and metallic plumbing lines, ...
1990-2000s	High-rise RC buildings	Advanced	+ False Ceilings, Façades (e.g., glass, stone), Finishes Services (e.g., Split and central ACs, advanced electrical power control devices, advanced plumbing features, fire fighting, multiple elevators, multiple water tanks on rooftops, data and communication cables, advanced bathroom fixtures), expensive furniture and contents of buildings

**Table 1.5:** Economic losses due to failure of NSEs [ATC 69, 2008]

<i>S No.</i>	<i>Earthquake</i>	<i>Losses due to failure of Nonstructural elements</i>
1	Loma Prieta 1989	\$ 50 million reported at some facilities
2	Northridge 1994	Economic loss associated with Northridge earthquake is as high as \$5.2 billion, which is five-sixth of the total direct economic loss to non-residential buildings
3	Nisqually 2001	Estimated \$2 billion loss was associated with damage to nonstructural components and business interruption
4	Niigata Ken 2004	Economic loss, both direct and indirect, sustained at Sanyo Electrical Company was in the tune of \$ 690 million



**Figure 1.22:** Evolution trends in costs of NSEs used in buildings over the last four decades: in India and in countries with advanced seismic provisions for design of buildings and NSEs



**Figure 1.23:** Cost share of structure and NSEs in building projects implemented in USA and Japan: Major cost share is of NSEs [Adapted from Takahashi and Shiohara, 2004]

Ideally, the response of NSEs should be studied in detail, and designed and detailed by the manufacturers of the NSEs for use in various projects. Details provided by manufacturers for use of NSEs should provide adequate caution to ensure that damage does not accrue beyond what is possible to be sustained by NSEs. Design provisions should be arrived at in consultation with the manufacturers, after thorough testing of NSEs on shake tables for examining levels of shaking that they can sustain without sustaining significant irreparable/repairable damage. Independent design for each and every individual NSE is tedious, and may not be suitable for NSEs that are used commonly in normal buildings and structures. But, such measures may be required for NSEs employed in *important, critical and lifeline buildings and structures*, such as *nuclear power plants* and *air traffic controls*. This book presents basic issues relevant to performance of NSEs during strong earthquake shaking, along with basic strategies for protecting them against such hazard.

...

## Conceptual Earthquake Behaviour of NSEs

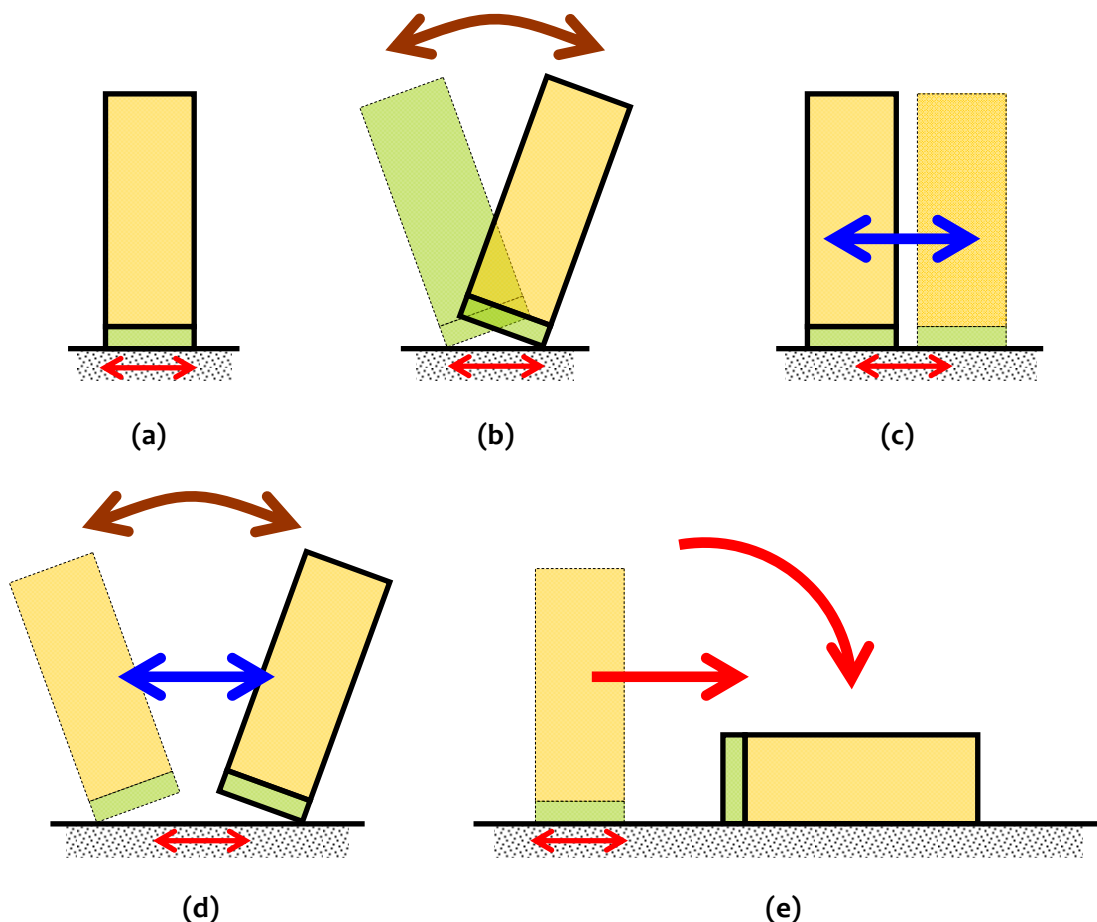
### 2.1 THE TWO CHALLENGES

An NSE in a building or structure is faced with two challenges during earthquake shaking, namely

- (1) *Inertia force* induced arising from the mass of NSE due to acceleration at the base of the SE on which the NSE is rested, and
- (2) *Deformation* (primarily *displacement*, but can be *rotation* also) imposed on the NSE between its support points on the SEs, when the support points undergo differential movement.

The former is concern especially for NSEs that have large *mass* and are *tall* and *narrow*, and the latter for NSEs that are *long* and *supported at more than one point on the same or adjoining SEs or buildings*. Both of these challenges are a concern for some NSEs that posses all of the above characteristics, namely massive, high, narrow and multiple supports. Usually, one of these effects is more significant than the other; the more significant effect is called the *primary effect*, and the other, the *secondary effect*.

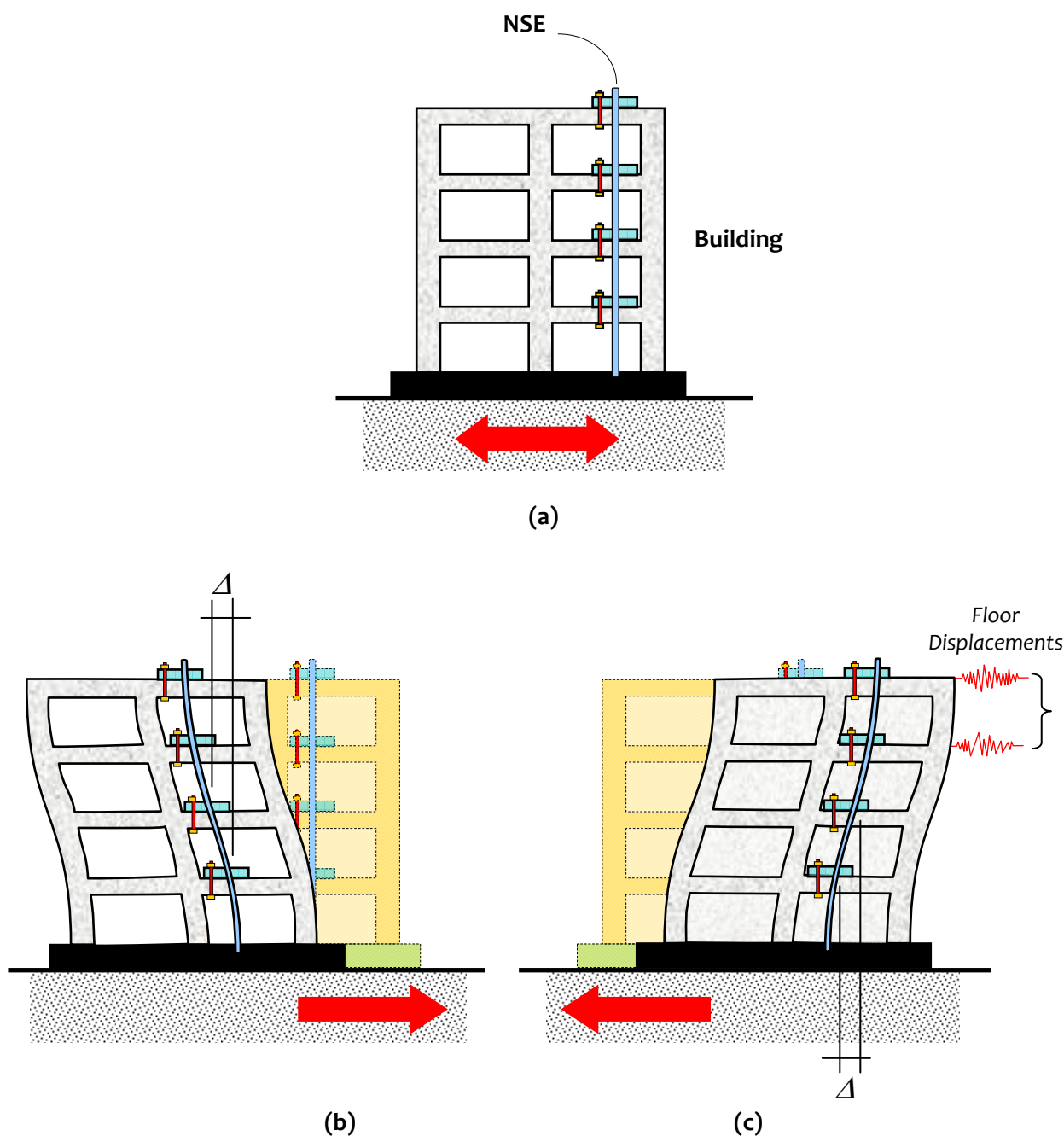
When an NSE with large mass and large height (e.g., a cupboard) that is simply rested on a base surface is shaken lightly at its base, it can stay as is (Figure 2.1a) or start *rocking* in its current position (Figure 2.1b). When its base dimension is large and shaking moderate, it may not rock, but just *slide* (Figure 2.1c). When the shaking is large, it may *slide and rock* together (Figure 2.1d), and when the shaking is severe, it may even *topple* (Figure 2.1e). Which of these actions will happen is determined together by overall dimensions of the NSE, mass of NSE, severity of shaking and coefficient of friction between the NSE and surface of SE on which it is rested.



**Figure 2.1:** NSEs with large mass shaken at its base: (a) tall NSE, (b) rocking of NSE, (c) sliding of NSE, (d) sliding and rocking of NSE, and (e) toppling of NSE

Consider an NSE of large length supported at more than one point on SEs. When the support points are shaken differentially during earthquake shaking, the NSE is subjected to differential *axial*, *lateral* or *combined axial-lateral movement* between its ends, depending on the orientation of the NSE and the direction of movement of the supports. Consider the pipe of a water main running along the height of the building (Figure 2.2a) in a low rise building. During earthquake shaking at the base of the building, the pipe is shaken differentially between successive support points at the floor levels (Figures 2.2b and 2.2c). The relative movement  $\Delta$  is in the horizontal direction and *transverse* to the pipe, irrespective of whether the shaking at the base is to the *right* or the *left*.

Thus, NSEs are of *three* types, namely (1) *Force-sensitive* NSE, (2) *Displacement-sensitive* NSE, and (3) *Force-and-Displacement-sensitive* NSE. Table 2.1 shows a list of NSE and categorises them into the above types.



**Figure 2.2:** NSEs of long length shaken at its support points: (a) Water Main in a building, (b) swing of the building to the *right*, and (c) swing of the building to the *left*

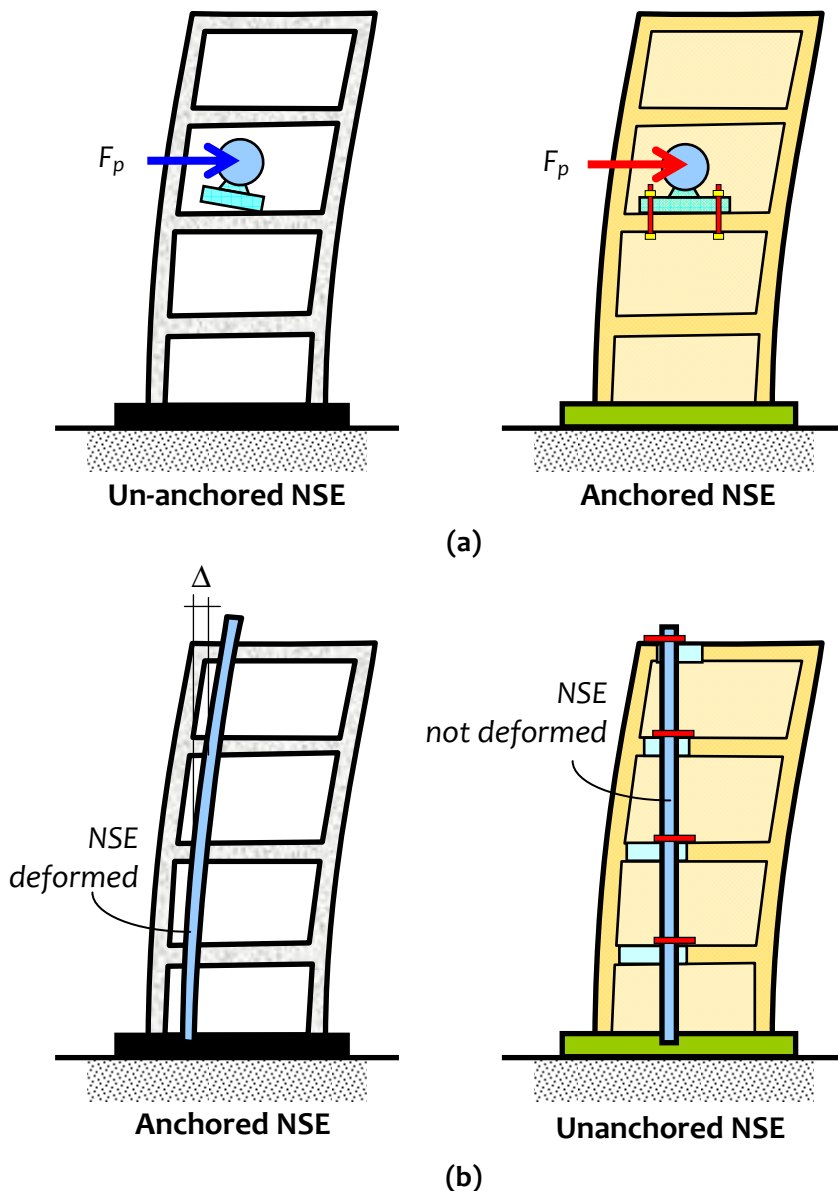
**Table 2.1:** Categorisation of commonly used NSEs based on earthquake behaviour [from FEMA 74, 2011]

Category	Sub-category	Non-Structural Element	Sensitivity		
			Force	Displacement	Both
<b>Consumer Goods inside buildings</b>	Furniture and minor items	1. Storage shelves 2. Multi-level material stacks	✓		
	Appliances	1. Refrigerators 2. Washing machines 3. Gas cylinders 4. TVs 5. Diesel generators 6. Water pumps (small) 7. Window ACs 8. Wall mounted ACs	✓		
<b>Architectural finishes inside buildings</b>	Openings	1. Doors and windows 2. Large-panel glass panes with frames (as windows or infill walling material) 3. Other partitions	Secondary	Primary	✓
	False ceilings	Directly stuck to or hung from roof	✓		
		Suspended integrated ceiling system	Secondary	Primary	✓
	Stairs		Primary	Secondary	✓
Partitions not held snugly between lateral load resisting members		Secondary	Primary	✓	
<b>Appendages to buildings</b>	Vertical projections	1. Chimneys & Stacks 2. Parapets 3. Water Tanks (small) 4. Hoardings anchored on roof tops 5. Antennas communication towers on rooftops	✓		
	Horizontal projections	1. Sunshades 2. Canopies and Marquees	✓		
		Hoardings anchored to vertical face	Secondary	Primary	✓
	Exterior or Interior Façade	Tiles (ceramic, stone, glass or other) (i) pasted on surface (ii) bolted to surface (iii) hung from hooks bolted to surface	Secondary	Primary	✓
Exterior Structural Glazing Systems		Secondary	Primary	✓	
<b>Services and Utilities</b>	From within and from outside to inside the building	1. Water supply pipelines 2. Electricity cables & wires 3. Gas pipelines 4. Sewage pipelines 5. Telecommunication wires 6. Rainwater drain pipes 7. Elevators 8. Fire hydrant systems 9. Air-conditioning ducts		✓	
	Inside the building	1. Pipes carrying pressurized fluids 2. Fire hydrant piping system 3. Other fluid pipe systems	Secondary	Primary	✓
	Storage Vessels and Water Heaters	1. Flat bottom containers and vessels 2. Structurally Supported Vessels	✓		
	Mechanical Equipment	1. Boilers and Furnaces 2. General manufacturing and process machinery 3. HVAC Equipment	✓		

## 2.2 THE PROTECTION STRATEGIES

Heavy and stiff NSEs are susceptible to *sliding, rocking and toppling* during earthquake shaking, if UN-ANCHORED, e.g., heavy motor; such NSEs are called *Force-Sensitive NSEs* (Figure 2.3a). And, light and flexible NSEs are susceptible to *stretching, shortening and shearing*, if ANCHORED, and are called *Displacement-Sensitive NSEs* (Figure 2.3b). Some NSEs are both massive and flexible; such NSEs are susceptible to both force and displacement effects. A list of NSEs used in practice is provided with photographs in Annexure A.

*Force-sensitive NSEs* are relatively more rugged (by virtue of their manufacture) than *displacement-sensitive NSEs*. Thus, *defiance* is the strategy for protecting the former type NSEs and *compliance* for the latter type. This means that in *force-sensitive NSEs*, the inertia force induced is to be resisted by NSEs ANCHORED to adjoining SEs (Figure 2.3a); the anchors are designed to have the requisite resisting force capacity. And, in *displacement-sensitive NSEs*, the expected relative displacement between the two support points of NSE is to be allowed to occur freely without any restraint against the expected deformation, i.e., UNANCHORED to the adjoining SEs; this is achieved by providing required physical space between NSEs and adjoining SEs, or using connectors that permit the expected deformation without allowing NSEs to separate from the SEs (Figure 2.3b).



**Figure 2.3:** Strategies for securing NSEs: (a) Force-sensitive NSEs to be anchored, and not left unanchored, and (b) Displacement-sensitive NSEs to be unanchored, and not anchored



### 2.2.1 Force-Sensitive NSEs

A force-sensitive NSE (that can *rock*, *slide* and *topple*) can be at any elevation on a building (Figure 2.4a). They can be secured by connecting them to any SE of the building, namely the *vertical* elements (like walls and columns), the *horizontal* elements (like slabs and beams), or *both*. In turn, these SEs of the building carry the inertia forces of these NSEs along the load path of the structural system of the building down to the foundation. For designing the connectors between the NSEs and the SEs of the building, separate calculations are required when NSEs are anchored to

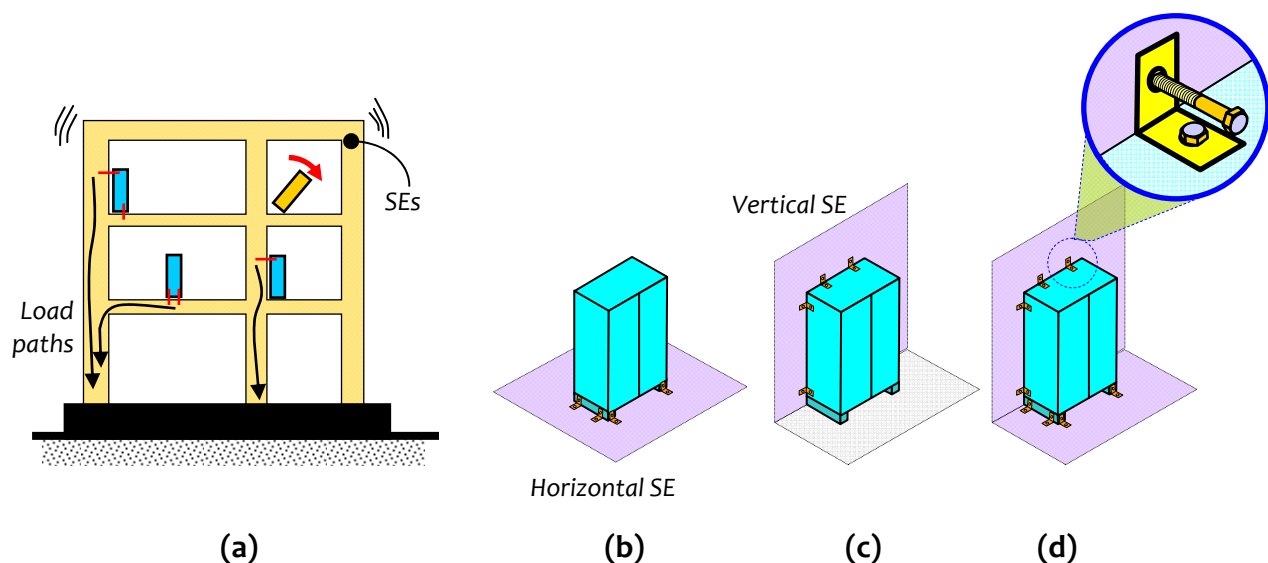
- (1) *Only horizontal* SEs of building (Figure 2.4b),
- (2) *Only vertical* SEs of building (Figure 2.4c), and
- (3) *Both horizontal and vertical* SEs of building (Figure 2.4d).

#### (a) NSEs anchored only to Horizontal SEs

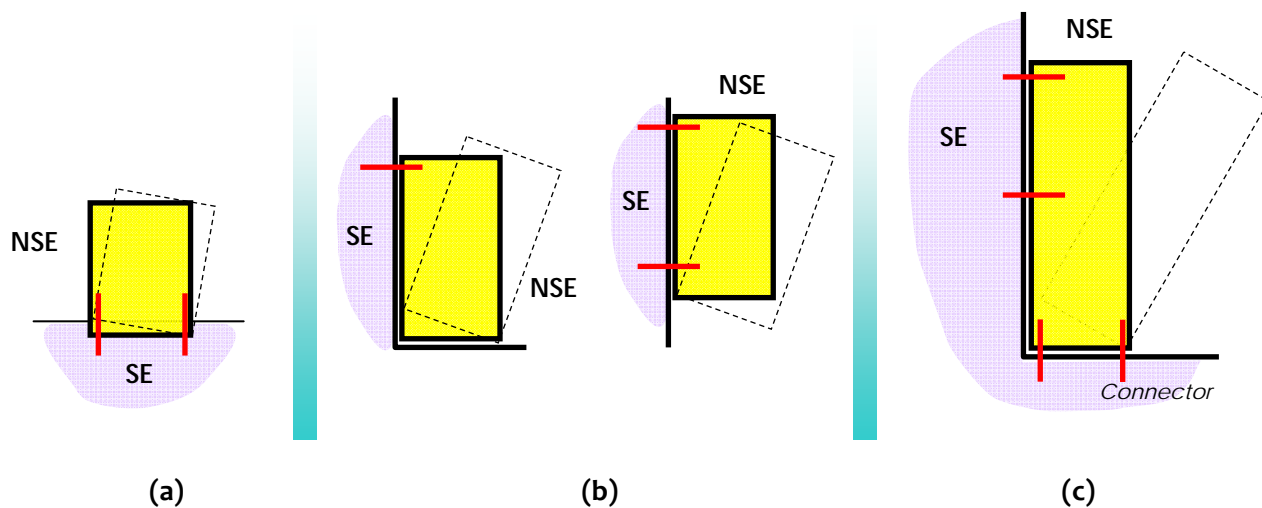
NSEs can topple under lateral earthquake shaking, if they are massive (*but not necessarily tall*) and do not have adequate width or grip at the base (Figure 2.5a), *e.g.*, parapets on roof tops, television set placed on table, plastic water storage tanks on roof tops, and machines & generators. Sometimes, these NSEs may not topple, but their sliding may cause other losses. Such NSEs can be made safe against toppling and/or sliding by just anchoring them at the base by taking support from the horizontal SEs. Sometimes, NSEs are hung from the horizontal SEs (*e.g.*, a chandelier hanging from the roof slab); they are vulnerable under strong shaking of SE, especially with dominating vertical component.

#### (b) NSEs anchored only to Vertical SEs

NSEs that are massive (*but moderately tall*) can topple under lateral earthquake shaking (Figure 2.5b), *e.g.*, refrigerators and cupboards. Such NSEs can be secured against toppling by anchoring them just at the top by taking support from vertical SEs. In special cases, even light and short NSEs can be anchored to vertical SEs, *e.g.*, LPG cylinders. These NSEs cannot be tampered with to create a proper grip to anchor them at their bases to horizontal SEs, but have a feature (*like the top ring in a LPG cylinder*) to enable anchoring them to vertical SEs. Some NSEs may have to be mounted directly on walls from functional considerations, *e.g.*, shelves and flat televisions mounted on walls. Caution is essential to ensure that walls on which such NSEs are mounted, can safely carry the NSEs and resist earthquake shaking in their out-of-plane directions. This is particularly a concern, when NSEs are mounted on unreinforced masonry infill walls. NSEs that are on shelves held against the wall also can be treated as wall mounted.



**Figure 2.4:** Securing force-sensitive NSEs: (a) Safety of NSEs is ensured by connecting NSEs to adjoining SEs of the building, (b) Connecting NSEs to *horizontal* SEs only, (c) Connecting NSEs to *vertical* SEs only, and (d) Connecting NSEs to both *horizontal and vertical* SEs



**Figure 2.5:** Anchors to secure force-sensitive NSEs: Anchor bolts are required to connect NSEs to SEs of the building, (a) Connecting NSEs to horizontal SEs only, (b) Connecting NSEs to vertical SEs only, and (c) Connecting NSEs to both horizontal and vertical SEs

### (c) NSEs anchored to both Horizontal and Vertical SEs

NSEs that are massive (*and* tall) can topple under lateral earthquake shaking (Figure 2.5c), *e.g.*, industrial storage racks stocking raw material or finished products. Such NSEs have a significant part of their mass at higher elevations, narrow width and large height. These factors make such NSEs candidates to topple, because they cannot be made safe against toppling by just anchoring them to horizontal SEs at their bases; supports are required at the upper elevations from vertical SEs also. Some false ceilings are held by both horizontal and vertical SEs.

## 2.2.2 Displacement-Sensitive NSEs

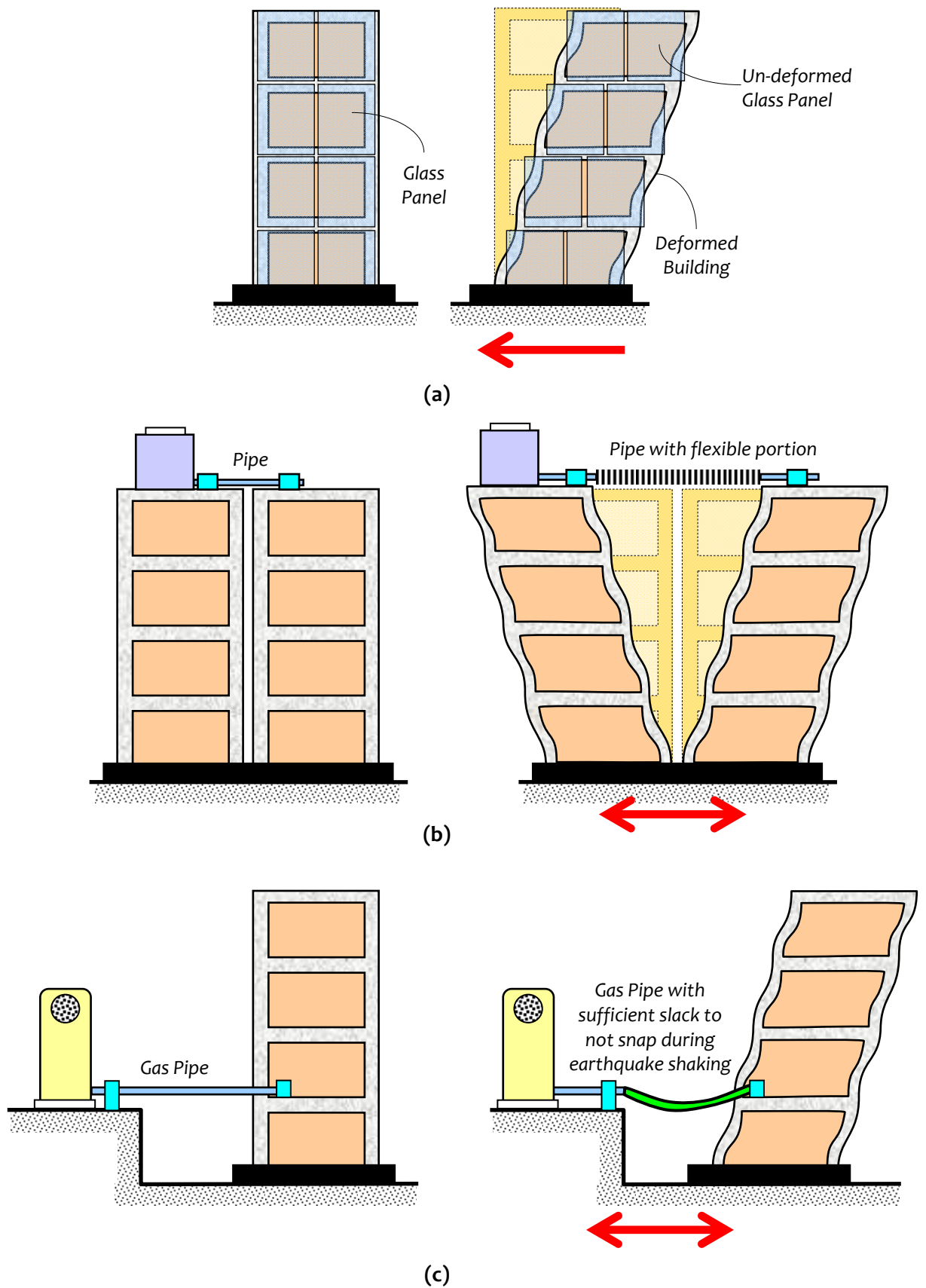
*Displacement-sensitive NSEs* (that can *pull*, *compress* and *shear*) move or swing by large amounts in *translation* and *rotation* under *elastic* and/or *inelastic deformations* of the SEs imposed on them during earthquake shaking, foul with adjoining NSEs, or pull off from supports on SEs, if anchored to them (Figure 2.6). Three situations of *relative displacements* in NSE arise when NSE spans between:

- (1) *Two SEs on the same building but at different elevations* (*e.g.*, façade glass panels appended on the outside surface across the height of the building) (Figure 2.6a);
- (2) *Two SEs that shake independently* (*e.g.*, a water main pipeline passing between the two parts of the building with a separation joint in between) (Figure 2.6b); and
- (3) *An SE on a building and the ground* (*e.g.*, a gas pipe between the building and a tank resting on ground) (Figure 2.6c).

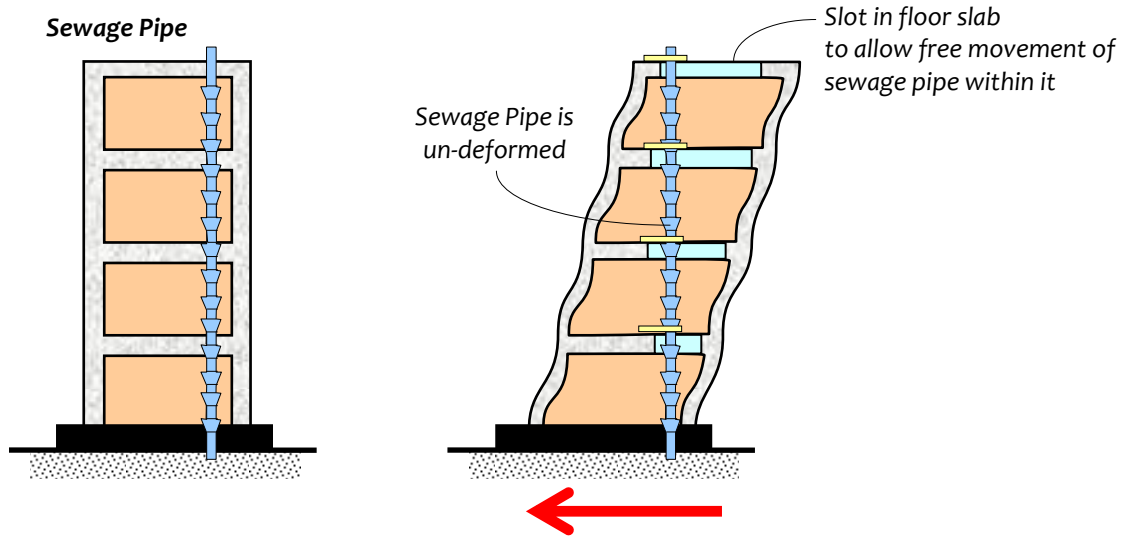
The strategy of design of connections should be to ensure that the relative displacement imposed at the support points is accommodated to occur freely, and not prevented from occurring.

### (a) NSEs supported on two SEs on the same building, but at different elevations

Usually, NSEs (that run across the height of a building) are supported at floor levels. During earthquake shaking, they are subjected to relative lateral displacement between successive supports. The relative displacement induced in the NSE between successive support points is estimated though the actual lateral displacements induced in the building at these floor levels. Long and slender NSEs, like segmented sewage pipes (Figure 2.7), are most vulnerable to such relative lateral translation between successive floor levels; the pipe joints open up leading to loss of function of the sewage pipe. Often, sufficient slot is left in the floor slab to allow movement of the pipe without relative deformation.



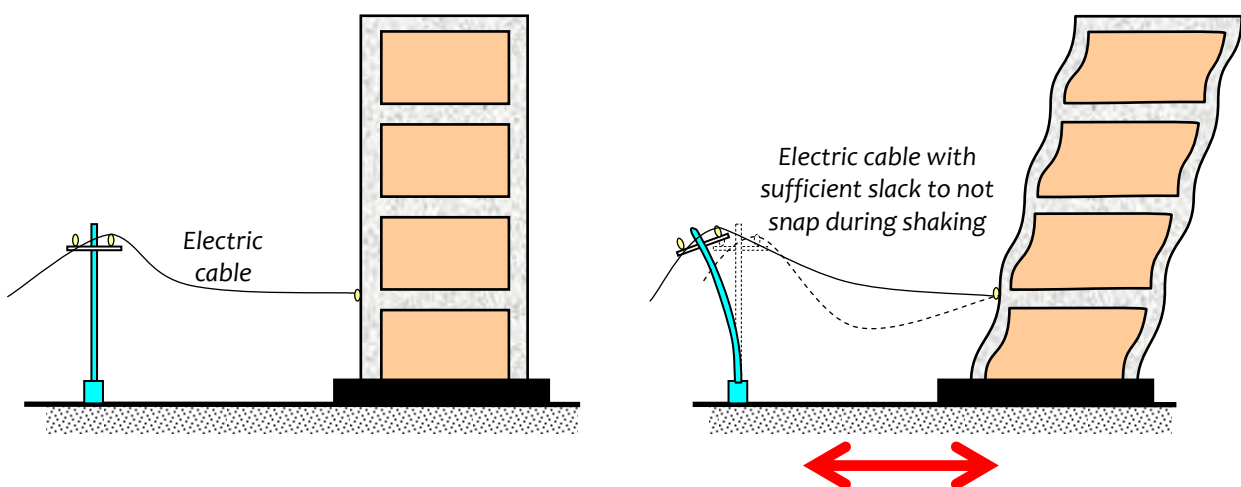
**Figure 2.6:** Displacement-sensitive NSEs: Spanning between (a) SEs running across height of a building, (b) SEs on two portions of a building across a construction joint, and (c) SE on a building and the ground



**Figure 2.7:** Displacement-sensitive NSEs between two SEs on the same building, but at different elevations: Sewage pipes running across the height of the building (a) should not be restrained, but (b) should be allowed to remain without deformation (the deformed shape of the building is exaggerated deliberately to amplify the action)

**(b) NSEs supported on two SEs that shake independently**

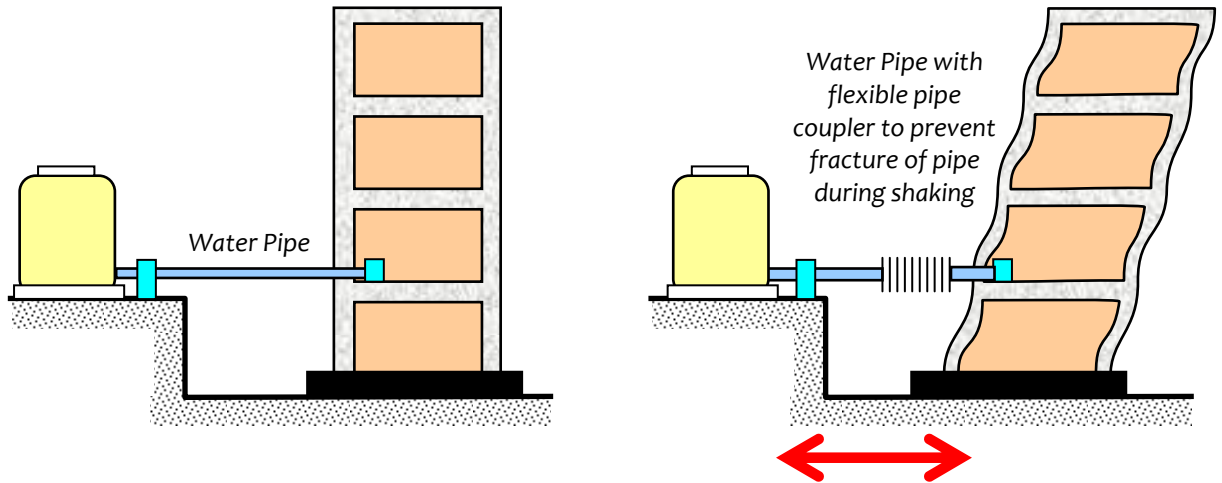
When plan dimensions of buildings are large, they are usually given a construction joint, which is designed as a seismic joint in building built in seismic areas. Understandably, two parts of the building at such seismic joints move relative to each other. NSEs held rigidly by supports that rest on these two parts of the building, are subjected to axial compression and elongation effects. Gas pipes, water mains, electric wires and communication wires running across this seismic joint from one part of the building to the other at any floor level, or electric supply cables that come from the nearby pole to the building (Figure 2.8), are subjected to these undesirable relative axial deformation effects. In keeping with the strategy of protection of such displacement-sensitive NSEs, it is appropriate only to allow this relative deformation to occur freely without any restraint. Often, extra slack or flexible pipe length is introduced to accommodate this relative deformation.



**Figure 2.8:** Displacement-sensitive NSEs between two SEs shaking independently: Electric cable from pole to the building (a) is tied taut, if relative displacement arising during seismic shaking is not considered, and (b) has sufficient slack to accommodate the relative displacement between its support points, if relative displacement arising during seismic shaking is considered

### (c) NSEs supported on a SE on building and the ground

Many critical NSEs span from outside ground to buildings, *e.g.*, water mains, gas mains, and electric cables. These should be provided with the freedom to move freely to accommodate the relative lateral displacement that is imposed when the ground and the floor on building shake differentially (Figure 2.9). For water pipes, two options are available – to provide slack in the pipe with a flexible segment, or through the use of flexible couplers that are known to accommodate designed amounts of relative displacement.



**Figure 2.9:** Displacement-sensitive NSEs between a SE on building and the ground: Water pipe from a water tank on ground to the building (a) is snug between the building and the tank, and vulnerable during earthquake shaking, and (b) is protected by the flexible coupler that is included along the length of the pipe to ensure safety during earthquake shaking

### 2.3 INTERACTION BETWEEN NSEs and SEs

When building shakes, NSE is shaken; this is expected. But, when the NSE shakes, does it affect the building, in turn? If it does, it is called *interaction* between the building and NSE. In literature [*e.g.*, Chen and Soong, 1988], when the interaction is present, the NSE is called a *Structural Secondary System*, and if it does not, it is called *Non-Structural Secondary Systems*. Table 2.2 lists the differences between the above two sets of NSEs. In this book, the NSEs discussed classify under *Non-Structural Secondary Systems* ONLY.

NSEs that have mass much smaller than that of the building on which they are held, say mass less than 1% of that of the building, the dynamic oscillation of the NSE does not alter the shaking of the building. As the mass of the NSE increases, the interaction between the response of the NSE and that of the building increases. If considerable interaction is expected between the responses of NSEs and SEs, then the building-SEs-NSE system is called a HYBRID structure; in such cases, the building should be modelled with both NSEs and SEs to determine the integrated response of the combined system. And, any change in design of NSE and its connection with the SE may even alter the structural demand on the SEs and hence their design. Response of NSE with interaction effects can be calculated on the basis of modal analysis of combined SEs-NSE system. The dynamic properties of combined system can be deduced from dynamic properties of both NSE and SEs considered independently. The demands on SEs and NSEs computed without accounting for interaction may be too conservative in some cases, and even un-conservative in others. With increase in nonlinearities in the building, the demand imposed on NSE may be higher or lower. Also, with increase in inelastic action, the natural period of the building increases; under such circumstances, resonance effects can be observed if the reduced natural period of the building coincides with that of the NSE.

**Table 2.2:** Comparison between NSEs and SEs [Chen and Soong, 1988]

<i>Basis for Comparison</i>	<i>Non-Structural Secondary System</i>	<i>Structural Secondary System</i>
Interaction between the secondary and primary system	Lateral inertia force generated by NSE is transmitted back to the building, but interaction (influence on structural behaviour of building) is NOT significant	Interaction is considered as NSE modifies structural behaviour of building on which it is mounted
Importance	NSE plays a vital role towards functioning of critical and/or important structures and their failure may have serious implications	Such items can affect safety of building on which it is mounted
Examples	Computer systems, control systems, machinery, panel, storage tanks and heavy equipments	Stairways, structural partitions, suspended ceilings, piping systems and ducts

...

## Chapter 3

# Behaviour of NSEs in Earthquakes

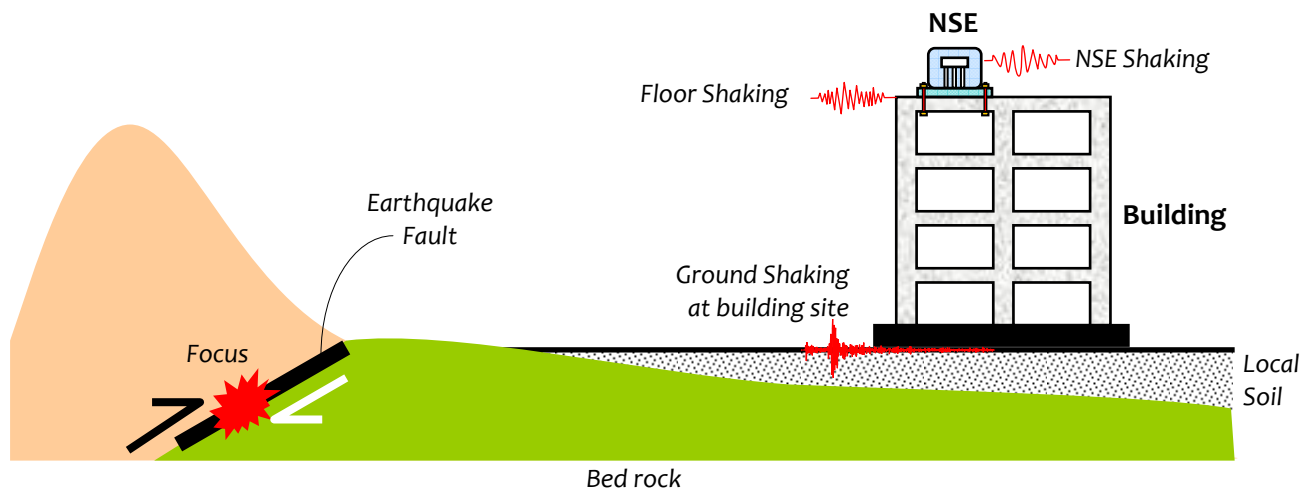
### 3.1 EFFECTS OF EARTHQUAKE SHAKING ON BUILDINGS

Buildings oscillate during earthquake shaking. The oscillation causes *acceleration, velocity and displacement* at every floor in the building. The intensity and duration of oscillation, and the amount of acceleration, velocity and displacement induced at every floor level in a building depend on the *characteristics of the earthquake shaking* and the *dynamic characteristics of the building*. Usually, acceleration, velocity and displacement induced at a floor level are different from those induced at other floor levels.

Characteristics of earthquake shaking that affect oscillations of floors (Figure 3.1) include

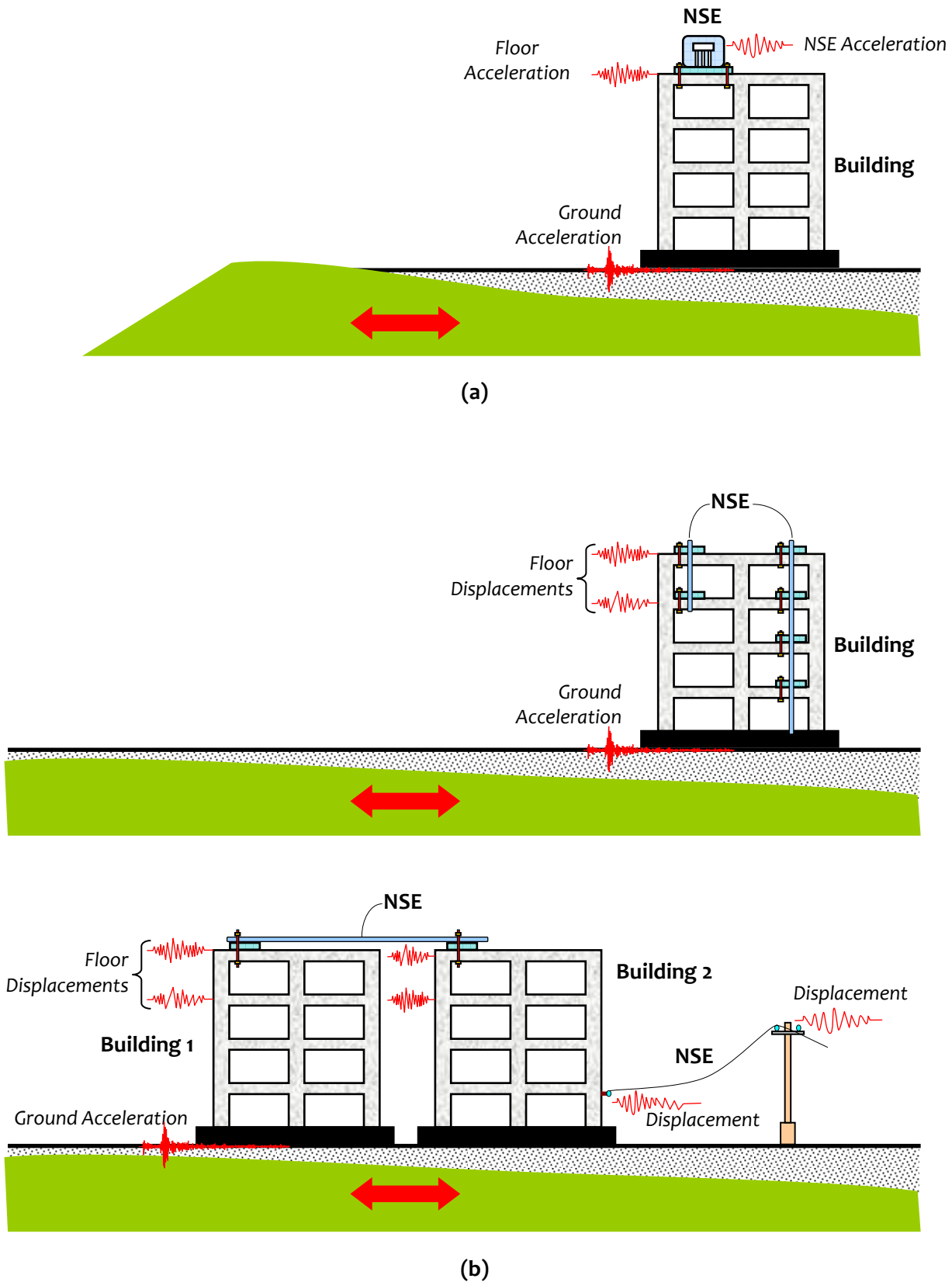
- (1) Distance of the fault responsible for the earthquake from the building in which the NSE is housed, the local soil type underneath that building,
- (2) *Frequency content, amplitude, and duration of shaking* of the ground motion, and
- (3) Dynamic characteristics of buildings like *natural periods of the building* in the direction of shaking and the associated *natural mode shapes of oscillation*, which in turn are governed by the mass and stiffness distribution in the building.

Here, if mass of NSE is small compared to that of the building or of the floor to which it is connected (e.g., mass of an adequately anchored television set), the additional inertia force mobilised in the NSEs is small and does not significantly affect the dynamic response of the building. On the other hand, if the mass of the NSE is *NOT* sufficiently small compared to that of the building or the floor to which it is connected (e.g., mass of an adequately anchored microwave tower on roof of a two-storey building), the additional inertia force mobilised in the NSE may significantly affect the dynamic response of the building. Such NSEs are also referred to as *Structural Secondary Systems*. Other examples of Structural Secondary Systems are large water tanks on roof tops of small buildings, stairways, structural partitions [Chen and Soong, 1988]. In such cases, the *primary* (i.e., the building) and the *secondary* (i.e., the NSE) systems should be analysed together as a *complete model* to obtain the effects of earthquake shaking. In general, these coupled systems are required to be considered, if the *mass ratio* (i.e., ratio of mass of NSE to that of building or floor to which it is connected) is more than about 0.10 and the *natural frequency ratio* (i.e., ratio of natural frequency of NSE to fundamental frequency of building) is close to 1.0. In this book, *complete models* are NOT discussed.



**Figure 3.1:** Seismic Setting of an NSE: All factors that affect building behaviour also affect earthquake behaviour of NSEs

Points on which NSEs are supported oscillate during earthquake shaking. As a consequence, two actions are imposed on NSEs (Figure 3.2), namely (a) *accelerations at their bases*, and (b) *relative displacements between the two ends of NSEs*, when NSEs are long and supported at two floor levels, on two buildings or on ground and the building. Thus, it is necessary to study *acceleration and displacement responses of buildings*.



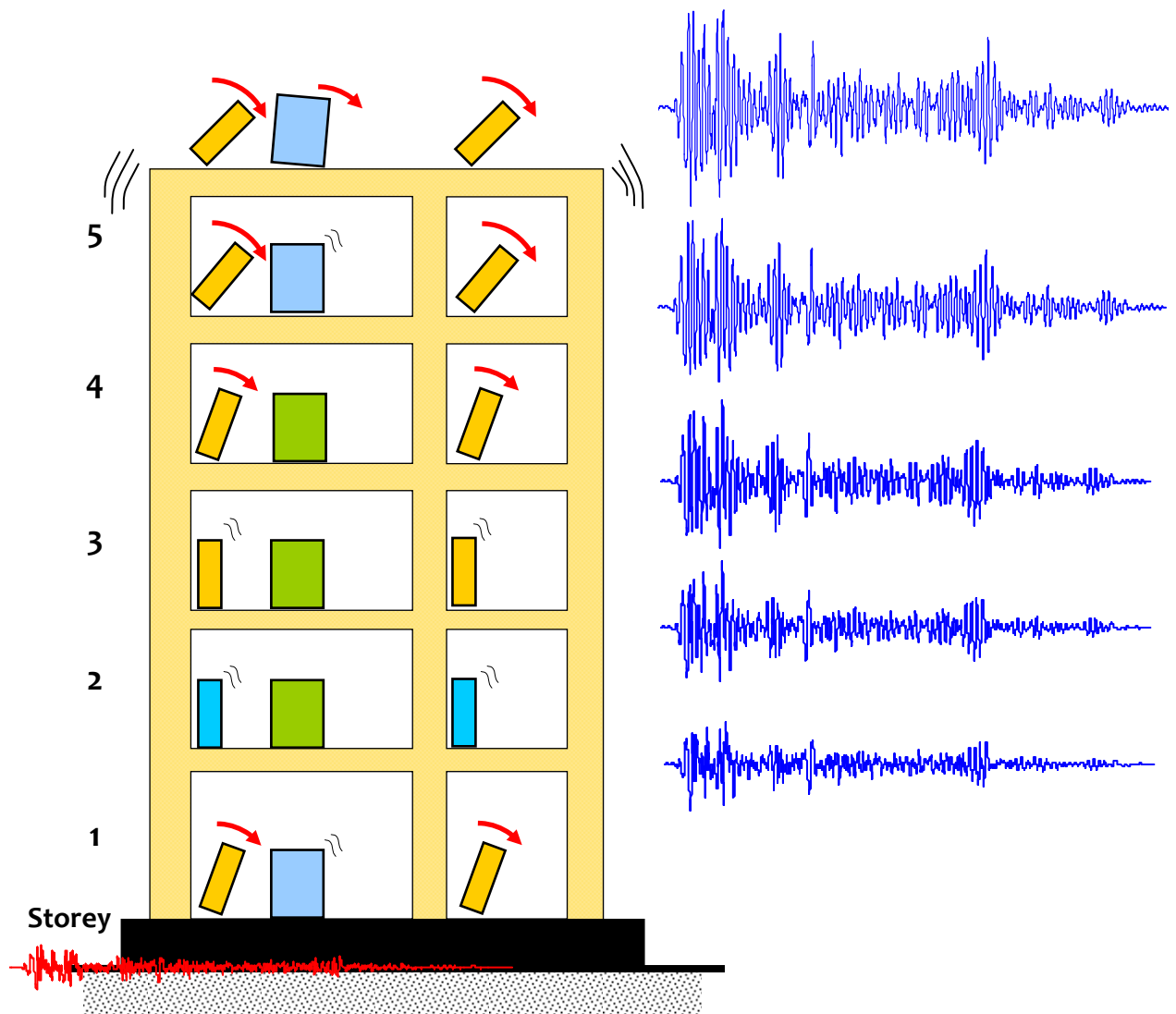
**Figure 3.2:** Two actions imposed on NSEs: (a) Accelerations at their base, and (b) Relative displacement between their ends



### 3.1.1 Floor Acceleration Response

#### (a) Concept

When a building is subjected to an earthquake ground motion at its base, the resulting acceleration histories are different at its various floor levels (Figure 3.3). The time histories of these *floor accelerations* are different from those of *natural accelerograms* (i.e., acceleration time histories of the ground during earthquakes). The acceleration history at a particular floor is the input *at the base of an NSE* mounted on that particular floor, just as the earthquake ground acceleration history is the input *at the base of the building*. Thus, identical NSEs placed at different floor levels experience different shaking histories when the building is subjected to an earthquake ground motion. Hence, studying the acceleration time histories at different floors of buildings is essential for meaningful design of NSEs supported at different floor levels.



**Figure 3.3:** *Acceleration histories at different floors:* Absolute acceleration time histories at different floors in a five storey RC building subjected to an earthquake ground motion at its base

## **(b) Obtaining Floor Acceleration Response**

In seismic design, a simple way of accounting for earthquake shaking effects is (i) estimating the maximum inertia force induced in the building or in a NSE, and (ii) using this as an equivalent static lateral force for design purposes. For rigid elastic NSEs, the induced inertia force is proportional to amplitude of shaking experienced at its base, which in this case, is the amplitude of floor acceleration at a particular floor in the building. Hence, the first step in seismic design of NSEs in a building is to obtain maximum floor acceleration (from the complete time history of floor acceleration) at each floor of the building, when the building is subjected to expected (*i.e.*, design level) earthquake ground motion at its base. This *floor acceleration response* is obtained through dynamic analysis of the building, without considering the dynamic properties (*i.e.*, mass, damping and stiffness) of the NSEs; in *Coupled Systems*, these *should* be considered.

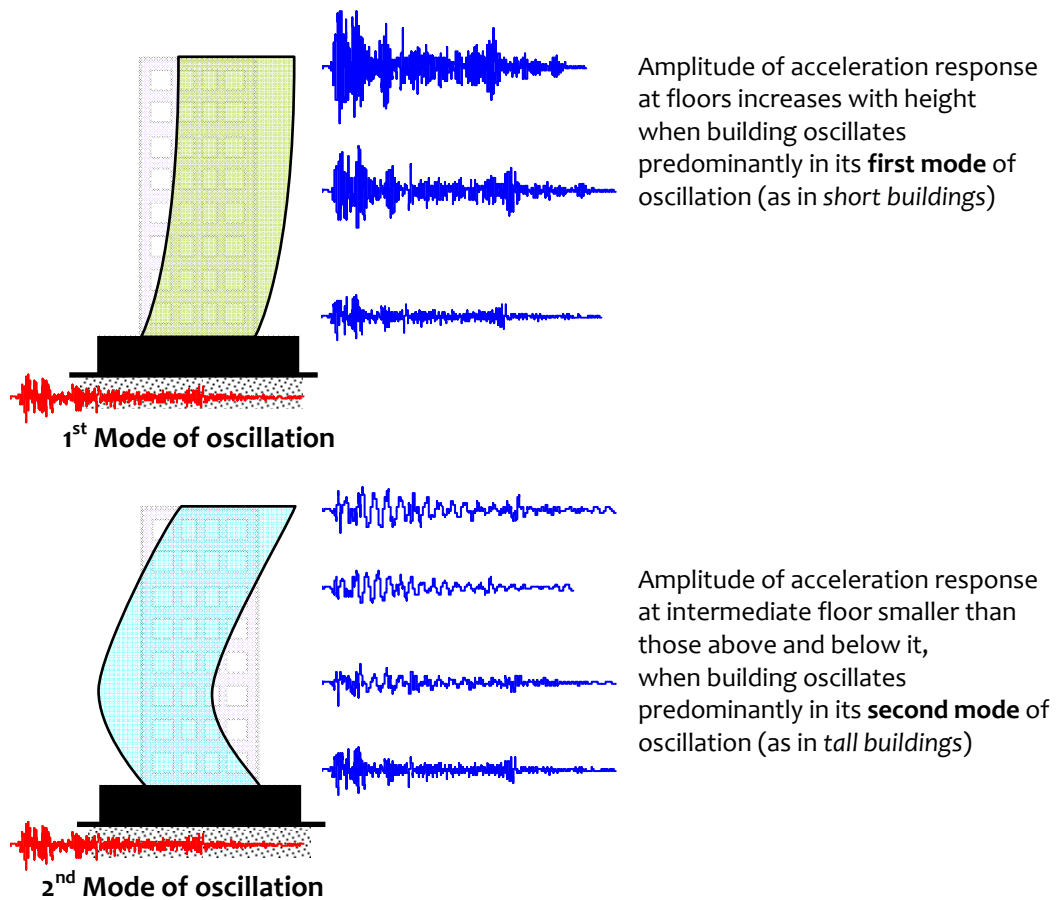
## **(c) Factors Influencing Floor Acceleration Response**

Structural system and height of a building critically govern a floor acceleration response under earthquake shaking. In general, proximity of fundamental natural period of a building (governed by the magnitude and distribution of mass and stiffness in the building) to the dominant frequencies carried by the earthquake ground motion largely governs acceleration response at any floor level in the building. Thus, floor acceleration response changes with building configuration and structural system (*e.g.*, moment frames, braced frames, or frames with structural walls). Height plays an important role in controlling fundamental natural period and fundamental natural mode shape of buildings. Buildings become laterally flexible as their height increases. As a result, natural periods of buildings increase with increase in height.

In general, low-rise buildings with small fundamental natural periods oscillate largely in their fundamental mode during earthquake shaking; their higher modes are stiffer and participate less in overall dynamic response. This leads to the commonly observed phenomenon of increasingly larger amplitude of floor acceleration response along the height of the building. But, in tall buildings, higher modes also have large fundamental natural periods and hence are shaken easily during earthquake shaking. Participation of higher modes of oscillation changes floor acceleration responses along height; this is evident from lower amplitude of floor acceleration response at an intermediate floor levels compared to those at floors below and above them (Figure 3.4).

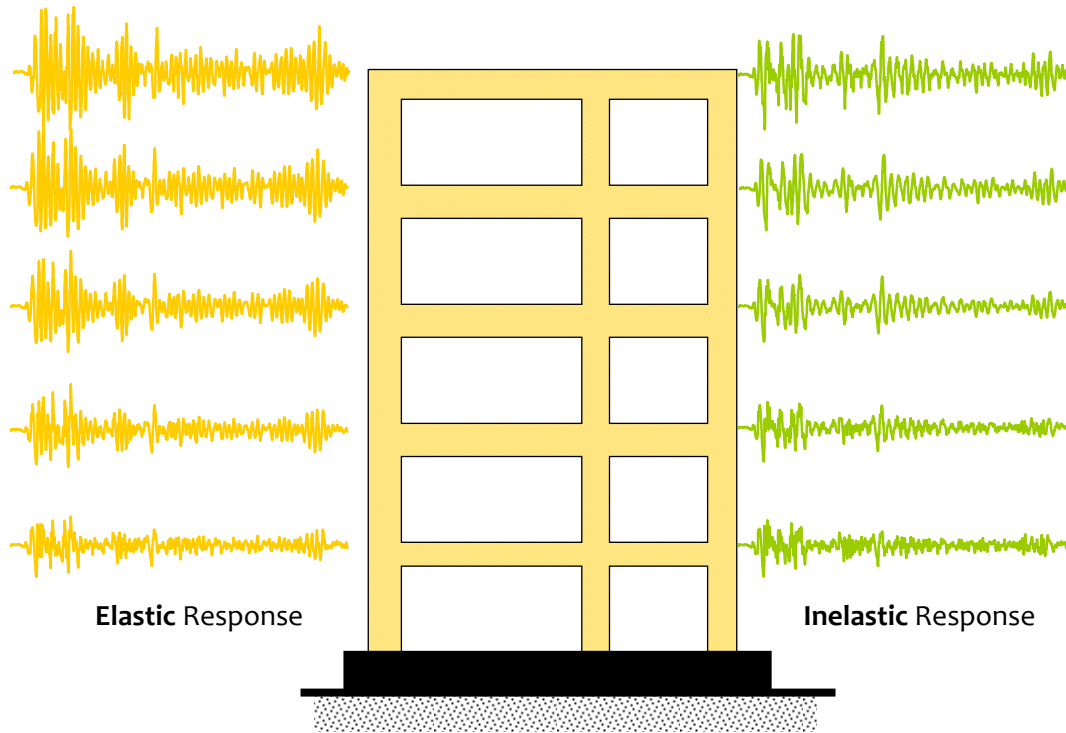
Additionally, the extent of participation of natural modes of oscillation of buildings is influenced by characteristics of earthquake ground motion at their base. Usually, earthquake ground motion contains a good mix of waves of different frequencies (in the range of 0-25 Hz, with large energy associated with waves having frequencies in the range of 2-10 Hz) that set buildings in motion. A dominant frequency of input motion close to a natural frequency associated with a higher mode of building increases the participation of that higher mode of oscillation. Thus, while floor acceleration response usually increases with height in buildings, a highly filtered ground motion (*e.g.*, due to local site effects) may excite higher modes of oscillation in buildings and cause distinctly different floor acceleration response at different floors.

Damping is an important *dynamic characteristic* of buildings. Larger damping results in smaller response, and *vice-versa*. Damping increases with increase in damage in buildings. Thus, there is no one number that is considered *exact*. As an engineering practice, designers tend to use a commonly agreed number of 5% of critical damping for all calculations related to design of buildings. Hence, damping is not in focus in this book.



**Figure 3.4:** Floor Acceleration Response: Acceleration response at a floor is affected by building height and by degree of participation of different modes of oscillation of the building

The above discussion is based on elastic behaviour of buildings during earthquake shaking. Floor acceleration responses change significantly with onset of inelasticity (or damage) in the building during strong earthquake shaking (Figure 3.5). In well designed buildings, inelasticity initiates at beam ends in the lower storeys, and with increased intensity of shaking, hinges form in beams in upper elevations of the building also. In poorly designed buildings with a lower weak and/or soft storey, inelasticity is contained in that particular storey alone. In either case, natural modes of oscillation and damping of the building change with increase in inelasticity, and, in turn, changes floor acceleration responses at different floor levels. In general, *amplitude of floor acceleration decreases with increase in damage*. Also, overall characteristics of acceleration response histories of floors change during the total duration of earthquake shaking. This is attributed to the building becoming more flexible with increased inelasticity and the overall lateral oscillation of the building being accommodated at the damaged inelastic regions in the form of increased rotations and displacements; this is in contrast to increased accelerations being generated in the building shaking elastically.



**Figure 3.5:** Floor Acceleration Response: Inelastic response significantly different from elastic response

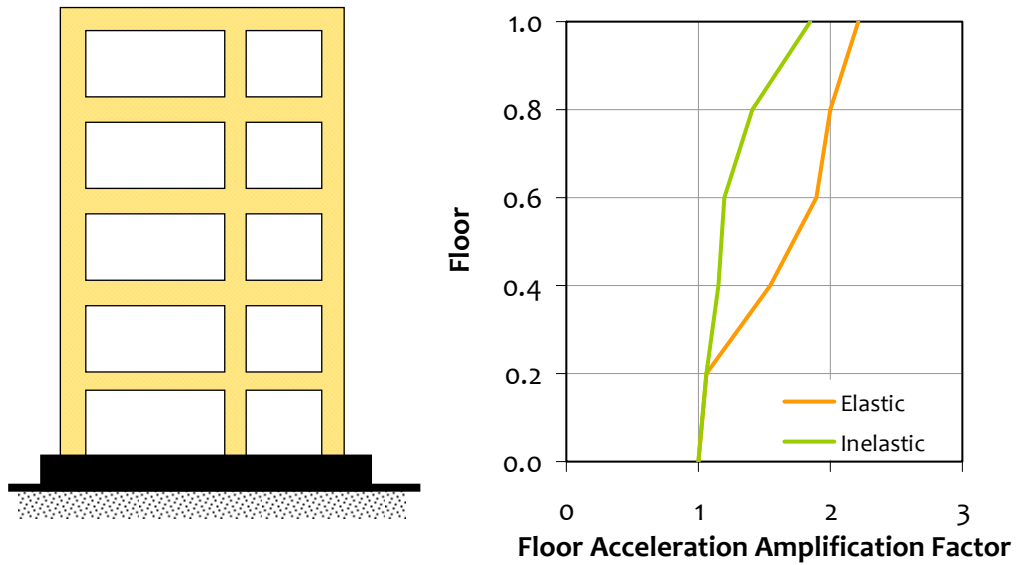
#### (d) Amplification Factors of Floor Accelerations at Different Floors

The ratio of absolute maximum acceleration generated in a floor in a building to the peak ground acceleration is called the *floor acceleration amplification factor*  $A_{floor}$ . Thus, all factors affecting acceleration response at a floor level also affect the floor acceleration amplification factor at that floor. Floor acceleration response (and hence amplification factor  $A_{floor}$ ) increases along height of buildings in most low-rise well-designed regular buildings, whose responses are primarily governed by their fundamental mode of oscillation. In most codes, the variation of this amplification factor  $A_{floor}$  is approximated to be linear along the height of the building, as

$$A_{floor} = \left(1 + \alpha \frac{z}{H}\right), \quad (3.1)$$

where  $z$  is height of floor under consideration from base of building,  $H$  the total height of building, and  $\alpha$  taking integer value of 1, 2 or 3.

The above approximation is not necessarily always true. Floor acceleration response can be smaller, at least in certain floors, in high-rise buildings with significant contribution of higher modes of oscillation. In such buildings, floor acceleration amplification *does NOT vary linearly* along height. Also, ratio of absolute maximum floor acceleration to peak ground acceleration can be less than 1.0 in some floors owing to inelastic effects in the building, and hence sometimes  $A_{floor}$  is referred to as *floor acceleration reduction factor*. In general, maximum amplification is experienced during elastic shaking of buildings (Figure 3.6), and hence codes tend to take a conservative approach, even though maximum reduction may be seen during high inelastic shaking.



**Figure 3.6:** *Floor Acceleration Amplification Factor:* Normalised maximum floor acceleration at different floors in a five storey RC building

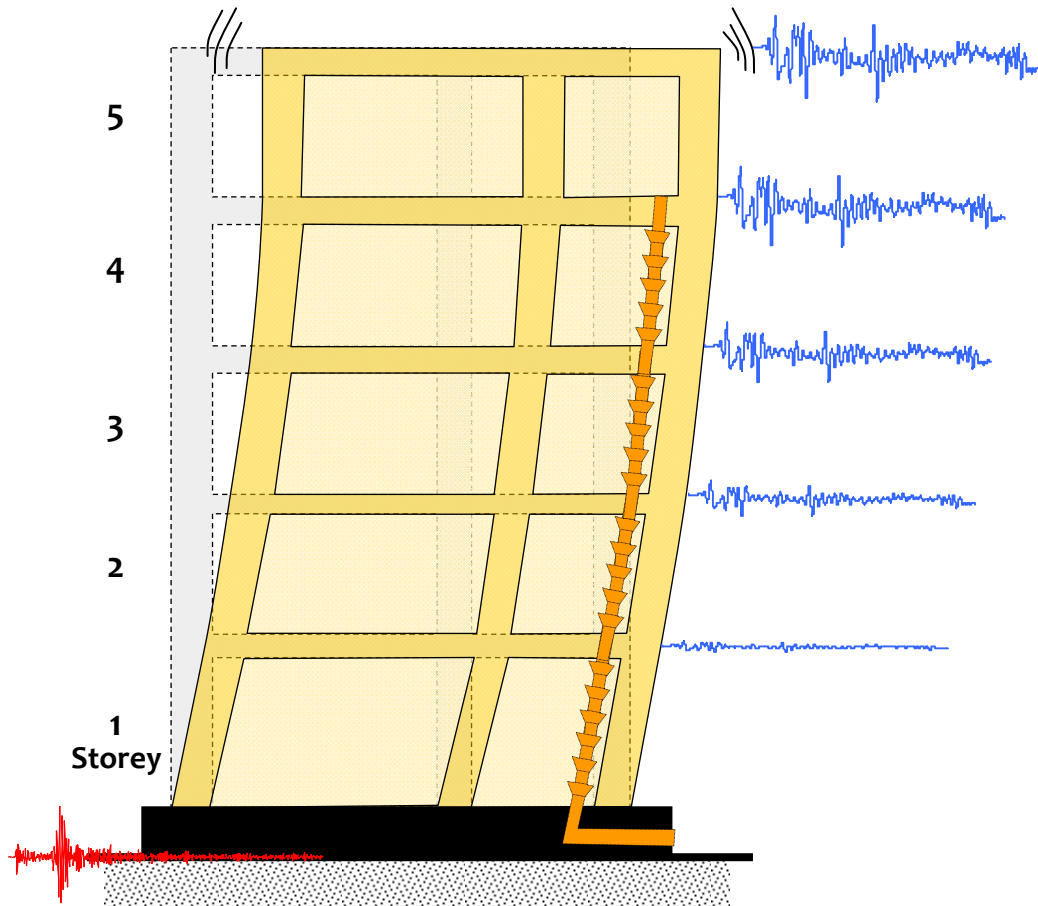
### 3.1.2 Displacement Response

#### (a) Concept

Displacement histories at different floors of a building also can be obtained just the way acceleration histories at different floors were. As with floor acceleration responses in a building, *floor displacement responses* also are different at various floor levels when building is subjected to earthquake ground motion at its base. And, floor displacement histories in buildings are different from ground displacement histories at their bases during earthquake shaking. Thus, NSEs extending between and anchored at two or more floors (*e.g.*, water pipes, sewage pipes, and gas mains) are subjected to relative deformations due to different shaking at floors to which they are connected (Figure 3.7). Therefore, displacement time histories should be studied at different floor levels in a building for design of *displacement-sensitive NSEs* supported at different floor levels.

#### (b) Obtaining Displacement Response and Inter-storey Drift

Seismic design involves obtaining maximum stress-resultants (*i.e.*, axial force, shear force, bending moment and torsion) induced in a NSE due to imposed relative deformation between its supports. For elastic systems, these stress-resultants generated are proportional to amplitude of relative deformations between supports at different floor levels. The relative lateral displacement between two consecutive floors or storeys in a building is called the *inter-storey drift*, and is expressed as a fraction or percentage of the storey height. This measure is useful in understanding the demand on displacement-sensitive NSEs. Hence, the first step in seismic design of *displacement-sensitive NSEs* in a building is to obtain the *history of floor displacements* at different floor levels and estimate from them *maximum inter-storey drift* generated in each storey during earthquake shaking. This *floor displacement* or *inter-storey drift response* is obtained through dynamic analysis of building, usually without considering the dynamic properties (mass, damping and stiffness) of NSEs; in *Coupled Systems*, these *should* be considered.



**Figure 3.7:** Displacement histories at different floors: Floor displacement time histories at different floors in a five storey RC building subjected to an earthquake ground motion at its base

### (c) Factors Influencing Displacement Response and Inter-storey Drift

Factors that affect *floor acceleration response* also affect *floor displacement response*, in particular, building structural system and height. As stated before, fundamental natural period of building governs displacement response at any of its floors, and floor displacement response changes with building configuration, structural system and height. Fundamental mode shape in well-designed low-rise moment frame buildings is of *shear-type*. This leads to the commonly observed phenomenon of larger amplitude of floor displacement response at higher elevations of buildings. On the other hand, participation of higher modes can be high in tall buildings with large fundamental period. Participation of higher modes of oscillation in tall buildings changes floor displacement responses along height, wherein floor displacement responses can be smaller at intermediate floor levels compared to those in floors below and above it (similar to floor acceleration response as in Figure 3.4).

But, since design of *displacement-sensitive NSEs* is governed by *relative displacement* between its supports, *maximum relative displacement* or *maximum inter-storey drift* is more important than just *maximum absolute displacement* at a floor. In well-designed low-rise buildings, inter-storey drift decreases upwards along height, although absolute maximum floor displacements increase under elastic shaking dominated by fundamental mode. On the other hand, in tall buildings, inter-storey drift can be small or large at intermediate storeys depending on participation of higher modes under elastic shaking. Also, since extent of participation of natural modes of oscillation of buildings is influenced by characteristics of earthquake ground motion experienced at the base, filtered far field motions can increase participation of higher modes of oscillation and cause high inter-storey drifts at intermediate storeys in tall buildings. Further, under inelastic conditions, buildings may sustain high inter-storey drift in storeys where inelasticity is present; in general, *inter-storey drift* increases with increase in damage.

### 3.2 EFFECTS OF EARTHQUAKE SHAKING ON NSEs

When buildings oscillate during earthquake shaking, NSEs mounted on them also oscillate. The oscillation causes *acceleration, velocity and displacement* in NSEs. The intensity and duration of oscillation of NSEs, and the acceleration, velocity and displacement induced in them depend on *dynamic characteristics* of NSEs, in addition to characteristics of *the earthquake and the building*. As mentioned earlier, accelerations induced in NSEs at a floor level are different from those induced in identical NSEs mounted on other floors of the same building.

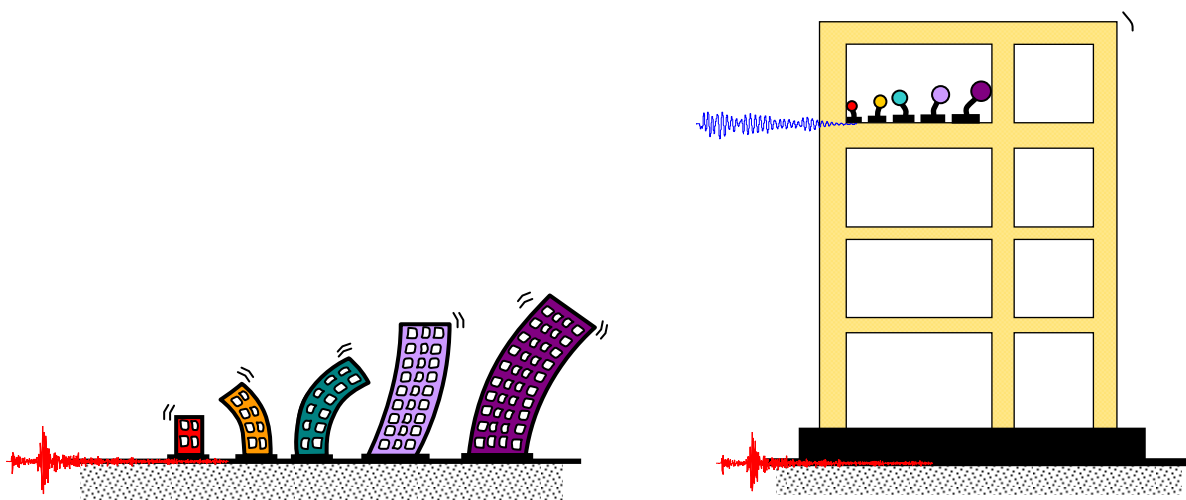
#### 3.2.1 Acceleration Effects

Seismic design of connections between force-sensitive NSEs and adjoining SEs is performed using maximum force induced in NSEs. This arises from acceleration in the building at the floors supporting the NSE during earthquake shaking. The force induced in NSEs can be estimated in two ways, namely: (i) *inertia force, i.e., mass  $m$  times acceleration  $a$* , or (ii) *elastic force, i.e., stiffness  $k$  times relative displacement  $x$* , as

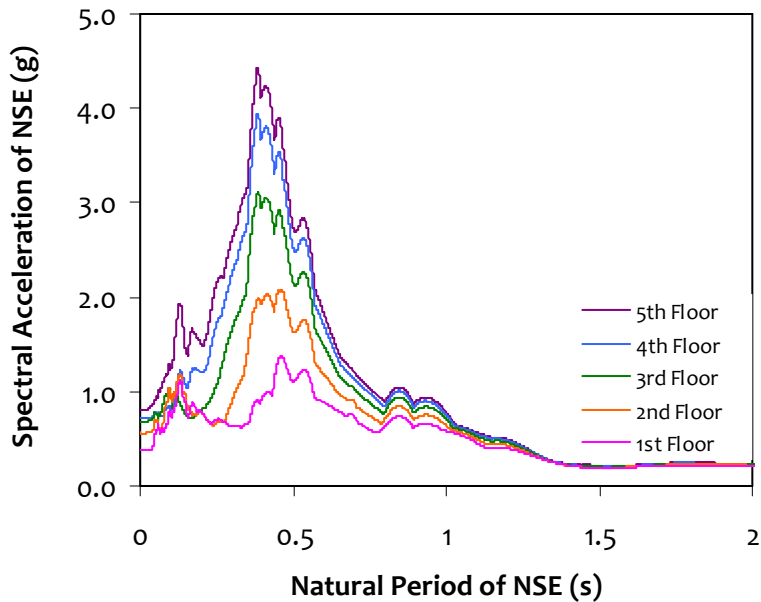
$$F = \begin{cases} ma \\ kx \end{cases} \quad (3.2)$$

It can be tedious to analyse each NSE under the different acceleration time histories that are possible at different floors. The mass and stiffness of different NSEs vary. Hence, it is sufficient to study NSEs with different natural periods  $T_{NSE}$  subjected to the same base shaking (representing various possibilities of floor acceleration time histories). This is similar to analysing different buildings with different natural periods  $T_{BUILDING}$  subjected to a particular earthquake ground motion; structural design process is simplified by generating *ground acceleration response spectrum* of the particular ground acceleration motion (this represents maximum acceleration response of buildings with different natural periods, but same structural damping, under same earthquake ground motion).

*Floor acceleration response spectrum*, or in short, *floor spectrum*, of a particular floor acceleration time history (and a specific value of damping) is a graph of maximum acceleration experienced by NSEs as ordinate and natural period  $T_{NSE}$  of NSEs as abscissa. It can be obtained for a spectrum of NSEs of different natural periods, but with same damping and adequately anchored to that particular floor, and subjecting them to the same acceleration time history associated with that floor (Figure 3.8). This eliminates need to perform dynamic analysis for each NSE. Five floor acceleration spectra corresponding to the acceleration at five floors of a five-storey RC building is shown in Figure 3.9 for 5% damping under the action of 1940 Imperial Valley earthquake ground motion (El Centro; S00E component) at the base of the building. The seismic inertia force generated in an anchored acceleration-sensitive NSE is obtained by multiplying the floor acceleration response spectrum value (from the floor acceleration response spectrum) with the mass of the NSE.



**Figure 3.8:** *Dependence of Response on Natural Period:* Time history of acceleration and displacement of mass is same for a number of NSEs with same natural period when subjected to the same floor acceleration history, and with same damping

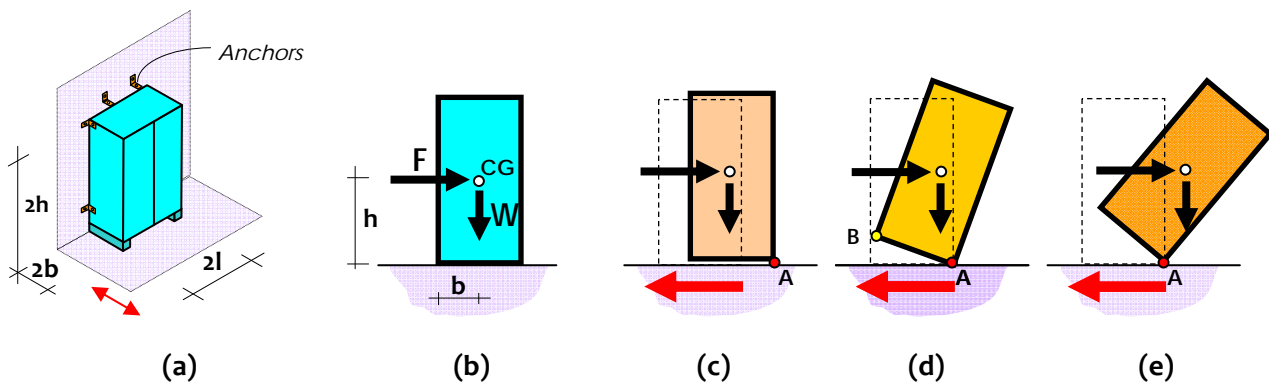


**Figure 3.9:** *Floor Acceleration Response Spectra:* Acceleration response of a spectrum of NSEs with different natural periods, but with the same damping (5% of critical) and subjected to the five different horizontal floor acceleration histories in a five storey RC building

The inertia force induced in an NSE (obtained using *floor acceleration response spectrum*) can cause the NSE to *slide*, *rock* or *topple* during random earthquake shaking, if it is unanchored in either the vertical or lateral direction, or if the anchor fails (Figure 3.10). *Sliding* means the base of NSE is completely in contact with the surface on which it is rested, but the NSE is horizontally translating on that surface after overcoming friction (Figure 3.10c). *Rocking* means NSE is not sliding, locked at its toe (*i.e.*, point A in Figure 3.10d) and lifts off from its heel (*i.e.*, point B in Figure 3.10d). *Toppling* means NSE is rocking, losing balance and finally ends up sideways on the surface on which it is rested (Figure 3.10e). Which of these three actions is possible depends on

- (a) *Intensity of shaking of surface* on which the NSE is rested (reflected by acceleration of that surface, or floor, in horizontal and vertical directions), and
- (b) *Geometry of NSE*.

In addition to the above three basic possibilities, the NSE also may simultaneously *slide* and *rock*.



**Figure 3.10:** *Sliding, Rocking and Toppling Hazard of NSEs:* Tendency in unanchored NSEs to displace during earthquake shaking depends on the level of lateral shaking and on the aspect ratio ( $B/H$ ) of the object - (a) Geometry of NSE, (b) Forces acting on NSE, (c) Sliding, (d) Rocking, and (e) Toppling



### 3.2.2 Displacement Effects

During earthquake shaking, NSEs shake along with SEs. Sometimes, NSEs are obstructed by SEs from freely shaking, if paths of oscillations of SEs and NSEs foul with each other and are not pre-rehearsed to accommodate the movements in the process of design. Since many NSEs are brittle and/or expensive, NSEs are damaged by SEs during earthquake shaking; sometimes, this damage can lead to threat to life of occupants of buildings. Hence, protection of NSEs is necessary. Also, relative displacement causes damage to NSEs or to their anchors to SEs. Thus, earthquake protection of these NSEs, called *displacement-sensitive NSEs*, requires understanding and estimation of relative movement between SEs and NSEs.

NSEs that are long (such as *pipes*) may need two or more supports. Consider two adjacent supports that hold an NSE (Figure 3.11). These supports of the NSE can be resting:

- (i) One on a building and the other on an adjoining building (Figure 3.11a),
- (ii) One at a certain level of a building and the other at a different level of the same building (Figure 3.11b), and
- (iii) One on ground and the other on the building (Figure 3.11c).

During earthquake shaking, these support points (which are basically SEs of the building in focus) can shake by different amounts and can lead to relative displacement in the NSE. Let one end of the NSE sustain an absolute lateral displacement of  $\Delta_{NSE1}$  and the other  $\Delta_{NSE2}$  (Figure 3.11b). For safety of the NSE, the relative displacement  $\Delta_p$  to be accommodated is the relative movement between the two supports. If the supports are moving away from each other, the *elongation-type* relative displacement  $\Delta_p$  that needs to be accommodated is:

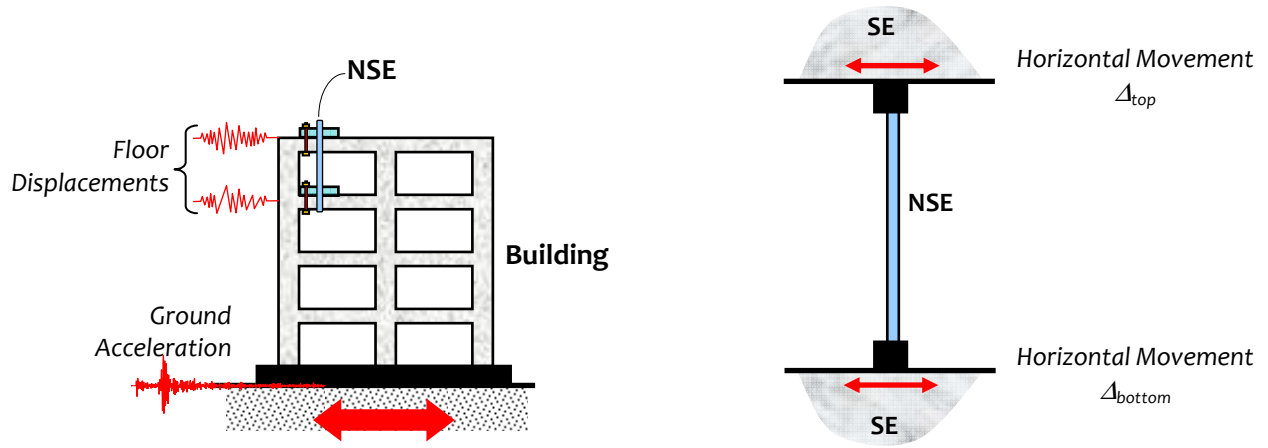
$$\Delta_p > |\Delta_{NSE1}| + |\Delta_{NSE2}|, \quad (3.3)$$

and if they move towards each other, the *compression-type* relative displacement  $\Delta_p$  that needs to be accommodated is:

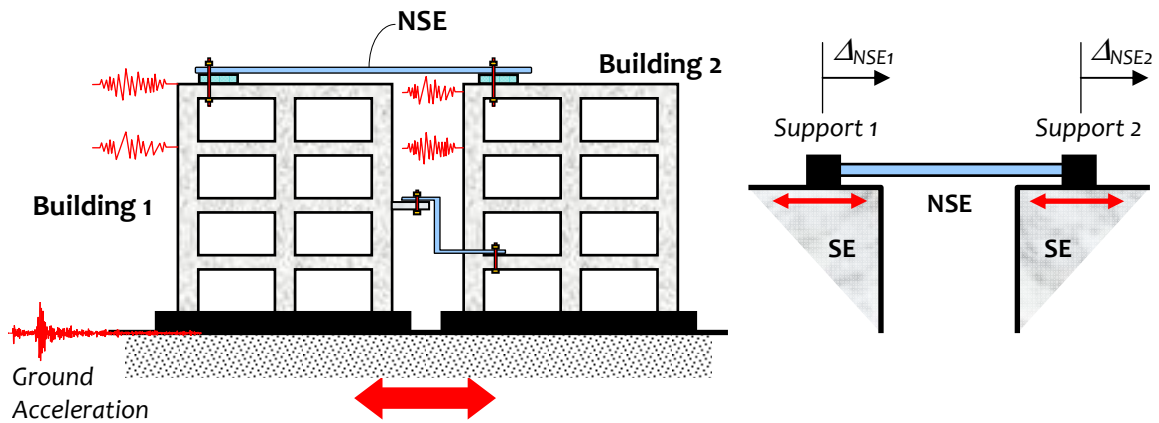
$$\Delta_p > \left| |\Delta_{NSE1}| - |\Delta_{NSE2}| \right|. \quad (3.4)$$

The maximum relative displacement  $\Delta_p$ , say, between consecutive floors in a building needs to be obtained for every storey (successive points of attachment of NSEs running along the building height). Structural analysis of building results in this relative displacement estimate; often, the relative displacement between adjacent floors is expressed as percentage of the storey height, and is called as *storey drift* (Figure 3.12).

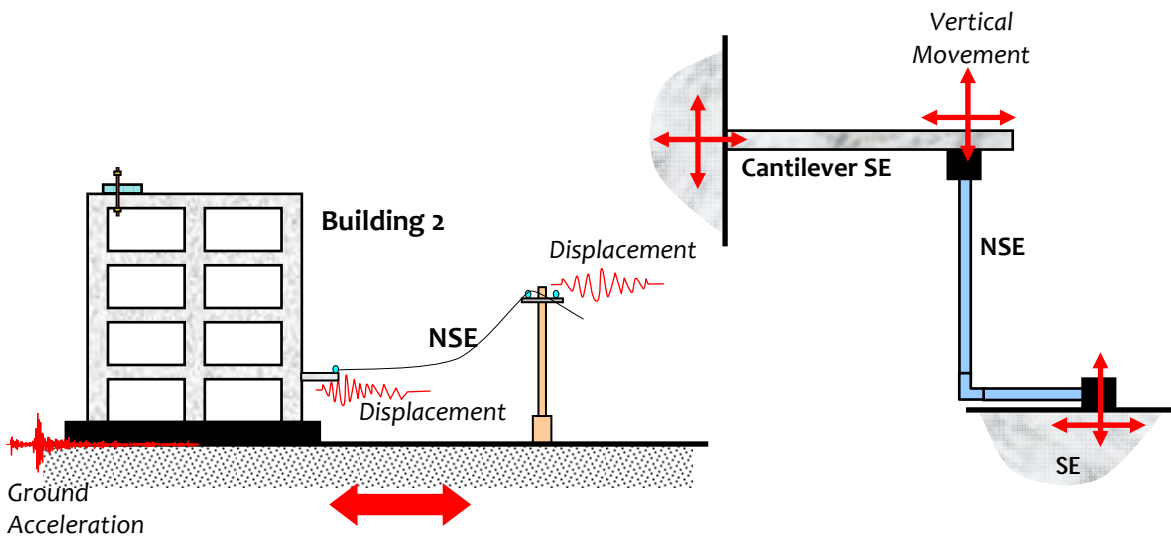
Only some NSEs can accommodate some relative displacements between their supports. If the above relative displacement is not explicitly accommodated through special strategies/devices, the NSE spanning between the supports is damaged. Thus, from point of view of safety of NSE during earthquake shaking, it is prudent to reduce this relative displacement demand by making buildings *stiff* in their lateral direction. For safety of NSEs in buildings, the main concern is the lateral movement of the supports of the NSEs (Figure 3.11a and 3.11b). But, when an NSE is resting on a horizontal cantilever, even vertical movements of the support points should be considered (Figure 3.11c); likewise, if it is resting on a vertical cantilever, horizontal movements of the support points should be considered. The imposed relative displacement between the ends of the NSE can be *lateral translational type* (Figure 3.11b), *axial type* (Figure 3.11b), or *both* (Figure 3.11c).



(a)

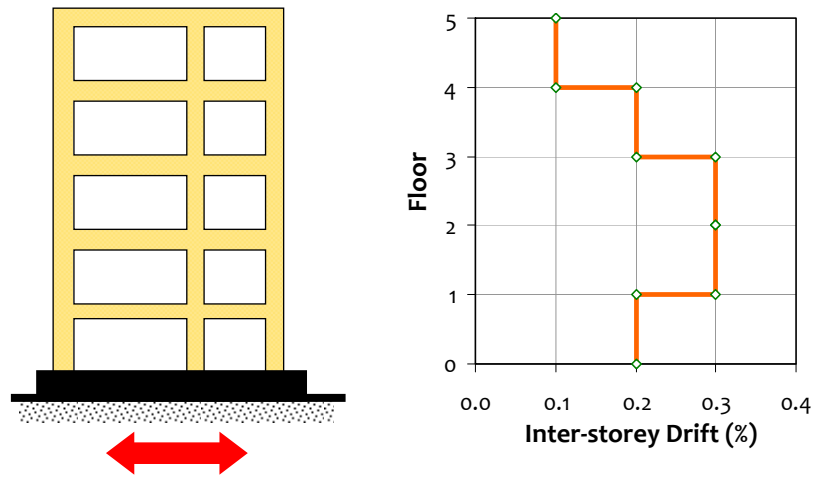


(b)



(c)

**Figure 3.11:** *Pulling and Shearing Hazard NSEs:* Movements at supports of NSE can be (a) both horizontal, but at different levels of same building, (b) both horizontal, but at same level in adjoining buildings, and (c) both vertical and horizontal, at different levels of same building or adjoining building/structure



**Figure 3.12:** *Inter-storey Drift:* Normalised maximum inter-storey drift in different storeys in a five storey elastic RC building

### 3.3 BEHAVIOUR OF UNANCHORED FORCE-SENSITIVE NSEs

Force-sensitive NSEs are usually massive and frictional resistance mobilised due to the self-weight of the NSEs provides the initial anchoring, that in turn, allows mobilisation of seismic inertia force in the NSE. Further, when a building is shaken by strong earthquake ground motion, the response at floor levels of the building is reasonably cyclic and of low frequency. The response is largely at frequencies close to natural periods of the building, especially those associated with lower modes of vibration.

The actual behaviour of NSEs is complex and nonlinear under dynamic earthquake shaking. Also, geometry and distribution of mass in a NSE could be non-prismatic and non-uniform, respectively. In this section, simplified response of unanchored force-sensitive NSEs is presented. Two basic assumptions are made, namely

- (1) All NSEs are considered to be rectangular in shape with their mass uniformly distributed along the entire volume of the object;
- (2) The motion at the base of the NSE is a simple sinusoidal motion of different frequencies.

In this section, simplified checks are presented for assessing the safety of the NSE against each of the 3 basic motions of acceleration-sensitive unanchored NSEs, namely *sliding*, *rocking* and *toppling*.

#### 3.3.1 Behaviour of SINGLE Block

Many items, such as refrigerators and televisions, used in daily life can be idealised as rectangular rigid objects with uniform mass rested directly on ground, floor and other supports (like tables). Thus, understanding behaviour of rigid unanchored blocks is critical to ensure seismic safety of these items. Consider a prismatic object of height  $2h$  and base dimensions  $2b$  (Figure 3.13), and shaking along the breadth  $2b$  of the object. Let the mass of the object be  $m$ ; its weight may be represented as  $W$ . Let  $r$  be half of the diagonal length of the rigid block. If the support under the object moves to the left with acceleration  $a_{eq}$ , then it is required to assess whether the object will *slide*, *rock* or *topple* to the right about point A. The conditions under which each of these basic modes response are possible are discussed below considering equivalent static horizontal earthquake inertia force.

**(a) Sliding Only**

Owing to self weight of the NSE, a frictional force of  $\mu W$  is generated at its base, where  $\mu$  is the coefficient of static friction. Under horizontal earthquake shaking, the object only will *slide* when BOTH of the following two conditions are satisfied, namely

(1) The earthquake-induced lateral inertia force  $F_{eq}$  is *more* than the frictional force  $\mu W$  at the base,  

$$F_{eq} > \mu W, \text{ and} \tag{3.5}$$

(2) The restoring moment due to self-weight of the NSE is *more* than the overturning moment due to lateral inertia force (when the moments are considered about point A)  

$$Wb > F_{eq}h. \tag{3.6}$$

Using gravity force  $W=mg$  and earthquake-induced inertia force  $F_{eq}=ma_{eq}$ , the above two conditions reduce to

$$a_{eq} > \mu g, \tag{3.7}$$

and

$$a_{eq} < \frac{b}{h} g. \tag{3.8}$$

**(b) Rocking Only**

Here, the frictional force is more than the earthquake-induced inertia horizontal force. Under horizontal earthquake shaking, the object only will *rock* when BOTH of the following conditions are satisfied, namely

(1) The earthquake-induced lateral inertia force  $F_{eq}$  is *less* than the frictional force  $\mu W$  at the base,  

$$F_{eq} < \mu W, \text{ and} \tag{3.9}$$

(2) The restoring moment due to self-weight of the NSE is *less* than the overturning moment due to lateral inertia force (when the moments are considered about point A)  

$$Wb < F_{eq}h. \tag{3.10}$$

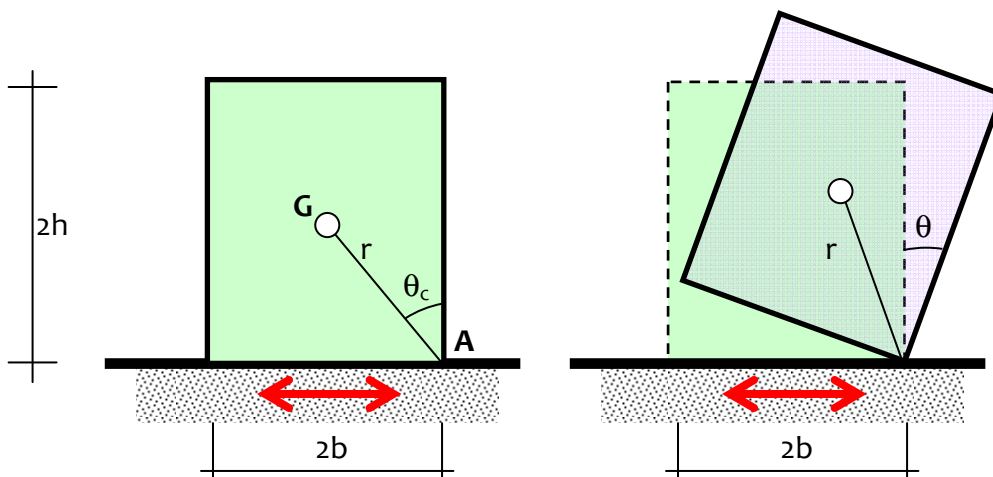
Again, substituting  $W=mg$  and  $F_{eq}=ma_{eq}$ , the above two conditions reduce to

$$a_{eq} < \mu g, \tag{3.11}$$

and

$$a_{eq} > \frac{b}{h} g. \tag{3.12}$$

The above is based on simple static consideration that the object returns back to the original vertical position, if the line of action of the self weight does not cross the toe, represented by point A.



**Figure 3.13:** Configuration of single rigid unanchored block: Geometries used in analyses

### (c) Toppling Only

Here the frictional force is more than the earthquake-induced inertia horizontal force. Under horizontal earthquake shaking, the object only will *topple* when the restoring moment due to self-weight of the NSE is *less* than the *dynamic* overturning moment due to lateral inertia force (when the moments are considered about point A). Hence, dynamic equations of equilibrium are required, which are available in literature and reproduced below [e.g., Yim et al, 1980, Makris and Roussos, 2000]. This is because all cases where the line of action of self-weight crosses the toe, may not lead to toppling of the block. Under dynamic condition, it is possible for an object not to topple but rock, even if momentarily the line of action of self-weight cross the toe represented by point A.

Therefore, there are four possibilities of a single rigid unanchored block shaken at its base with a sinusoidal excitation of frequency  $\omega$ . These are sliding, rocking, combined sliding-and-rocking, and toppling. Equations governing rocking response subjected to horizontal acceleration  $a_{eqbx}(t)$  at the base of the block in terms of  $\theta(t)$  (Figure 3.13), the angle between vertical and normal to base of the block are:

$$\begin{aligned} I_0 \ddot{\theta}(t) + mgr \sin(-\theta_c - \theta(t)) &= -ma_{eqbx}(t)r \cos(-\theta_c - \theta(t)) \quad \text{for } \theta(t) < 0 \\ I_0 \ddot{\theta}(t) + mgr \sin(+\theta_c - \theta(t)) &= -ma_{eqbx}(t)r \cos(+\theta_c - \theta(t)) \quad \text{for } \theta(t) > 0' \end{aligned} \quad (3.13)$$

where  $I_0 (= 4mr^2 / 3)$  is the mass moment of inertia of the block and  $r$  half the diagonal length. Expressing Eq.(3.13) in a compact form,

$$\ddot{\theta}(t) = p^2 \left[ \sin\{\theta_c \text{sgn}(\theta(t)) - \theta(t)\} + \frac{a_{eqbx}}{g} \cos\{\theta_c \text{sgn}(\theta(t)) - \theta(t)\} \right], \quad (3.14)$$

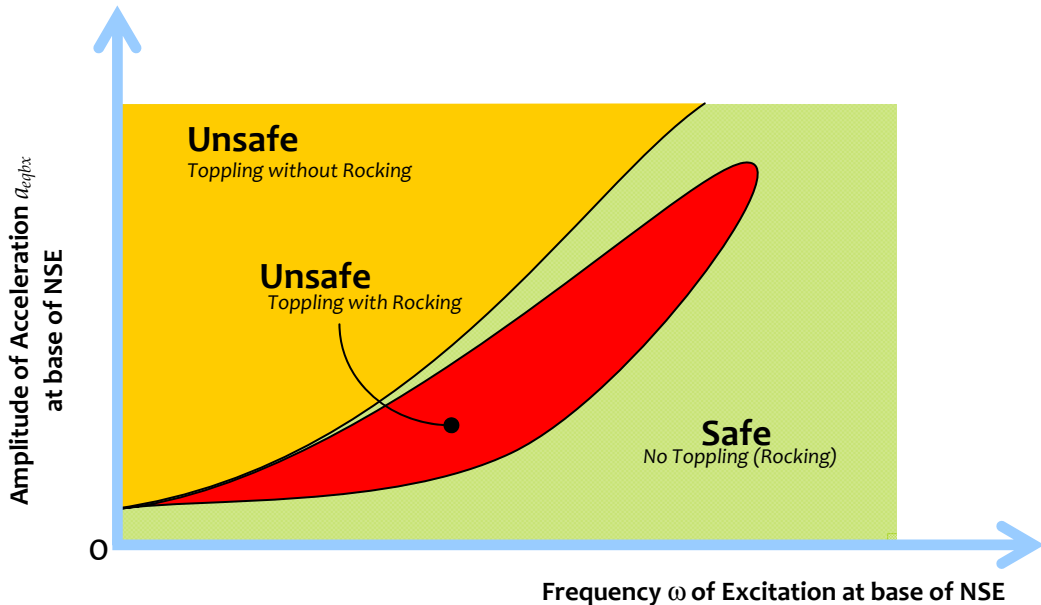
where  $p = \sqrt{3g/4r}$ .

Eq.(3.14) is nonlinear and can be solved numerically. It provides the maximum toppling acceleration values, and thereby the condition of overturning. There are two modes of toppling of the block, namely

- (a) *Mode 1*, where the block rocks and eventually topples, and
- (b) *Mode 2*, where the block does not rock, but simply topples.

Thus, for different values of  $\omega/p$ , peak base accelerations can result in three cases (Figure 3.14) of

- (i) *No Toppling (only Rocking)*,
- (ii) *Toppling without Rocking*, and
- (iii) *Toppling with Rocking*.



**Figure 3.14:** Rocking and Toppling behaviour of a single unanchored rigid block: Domain of safety against toppling

In general, toppling of unanchored rigid NSEs depends on the product of the acceleration amplitude of the forcing pulse by its duration, or incremental velocity (area under the acceleration pulse); potential of toppling is not merely dependent on peak (ground) acceleration at base [Housner, 1963; Milne 1885; Hogan 1989]. Also, larger of two geometrically similar rigid block NSEs can survive a given excitation whereas smaller block NSEs may topple, *i.e.*, rocking behaviour depends on system parameters also [Housner, 1963; Yim *et al.*, 1980]. Further, rocking response of blocks subjected to earthquake motion is in line with the above conclusions derived from single pulse excitations [Aslam *et al.*, 1980]. Thus, the solutions presented above reasonably assess the vulnerability of unanchored rigid blocks to rocking and toppling during earthquake shaking; the safe and unsafe regions as shown in Figure 3.14 reasonably well represents seismic behaviour of unanchored rigid blocks [Spanos and Koh, 1984; Makris and Roussos, 1998]. Also, toppling of smaller blocks depends on duration of the pulse in addition to the incremental velocity at base (area under the acceleration pulse), whereas toppling of larger blocks tends to depend solely on the incremental support velocity. Accordingly, a smaller block is likely to topple due to the high-frequency fluctuations that override long duration pulses, whereas a larger block, say rested on ground, is likely to overturn due to long duration pulses, such as those in near-field motions [Anderson and Bertero, 1986; Markis, 1997; Makris and Roussos, 1998].

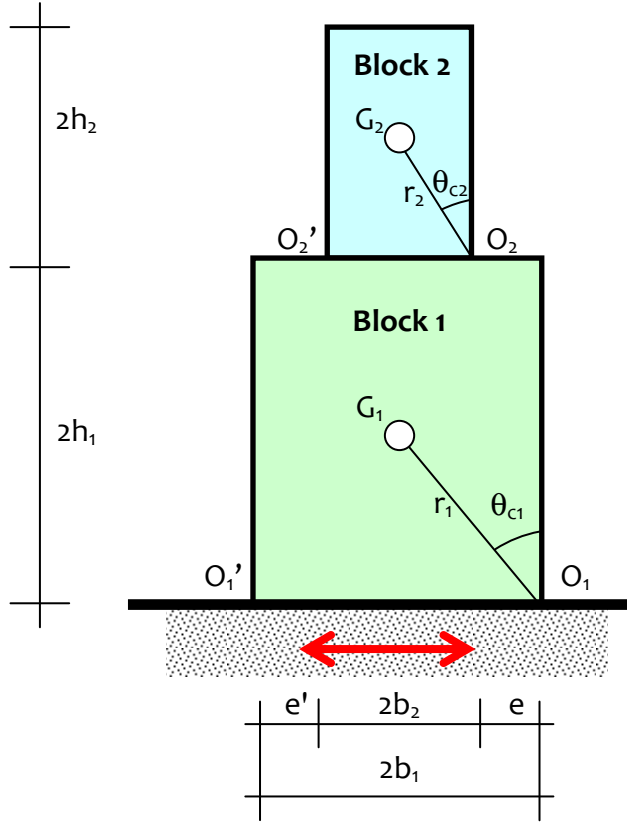
### 3.3.2 Behaviour of TWO Stacked Blocks

Another common situation with force-sensitive NSEs is that they are stacked one on top of the other. These can be at any level of the building. There are different possibilities of the response of stacked blocks, when the base of the lower block is shaken by the floor oscillating during earthquake shaking of the building. Figure 3.15 shows geometric characteristics of two symmetric rigid blocks. The rocking response is discussed in this section of this two-block system standing freely on a rigid horizontal floor surface, assuming *no sliding*; the top block rests symmetrically on the base block. The blocks have:

- (1) Masses  $m_1$  and  $m_2$ ,
- (2) Mass moments of inertia  $I_1$  and  $I_2$  about the axis passing through the centroid,
- (3) Base widths  $2b_1$  and  $2b_2$ , and
- (4) Heights  $2h_1$  and  $2h_2$ .

The bottom right (corner) points of the blocks are denoted as  $O_1$  and  $O_2$  and the left (corner) points as  $O_1'$  and  $O_2'$ . The edge distance of the top block on the bottom block on the right side is  $e$  and that on the left side  $e'$ . Angles between the vertical and normal to the base of the blocks are  $\theta_1$  and  $\theta_2$ . Center of mass of the two blocks denoted as  $G_1$  and  $G_2$ ; their distances from the bottom right (corner) points are  $r_1$  and  $r_2$ .

The two-block system has two degrees of freedom, namely  $\theta_1$  and  $\theta_2$ , denoting the angles of rotation of the two blocks with respect to the vertical. When subjected to base excitation, the system has four possible patterns of rocking motion with respect to the angles of rotation  $\theta_1$  and  $\theta_2$  (Figure 3.16). In Modes 1 and 2, both degrees of freedom are exercised (Figure 3.16a and b); they involve rotations of the two blocks in the same or opposite direction. In Modes 3 and 4, only one degree of freedom is exercised (Figure 3.16c and d); Mode 3 describes motion of the system rocking as one rigid system, and Mode 4 describes motion of the system with only the top block experiencing rocking.



**Figure 3.15:** Configuration of two rigid blocks stacked atop each other: Geometries used in analyses

**(a) Initiation of Motion**

Appropriate criteria are derived below for the initiation of rocking motion of the system when subjected to a base excitation with horizontal and vertical components  $a_{eqbx}$  and  $a_{eqby}$ , respectively. Specifically, the system may be set into rocking either in Mode 3 or in Mode 4, when the overturning moment of the horizontal inertia force (arising from  $a_{bx}$ ) about bottom corner of one block exceeds the restoring moment due to weight(s) of block(s) and vertical inertia force (arising from  $a_{by}$ ). The criteria for motion initiation of rocking are:

$$\begin{aligned}
 -ha_{bx} - b_1a_{eqby} &> b_1g && \text{for transition from rest to Mode 3 (swing to the right)} \\
 +ha_{bx} - b_1a_{eqby} &> b_1g && \text{for transition from rest to Mode 3 (swing to the left)} \\
 -h_2a_{bx} - b_2a_{eqby} &> b_2g && \text{for transition from rest to Mode 4 (swing to the right)} \\
 +h_2a_{bx} - b_2a_{eqby} &> b_2g && \text{for transition from rest to Mode 4 (swing to the left)}
 \end{aligned} \tag{3.15}$$

where  $g$  is acceleration due to gravity, and  $h$  the distance of the center of mass of the system from the base of the base block, given by

$$h = \frac{m_1h_1 + m_2(2h_1 + h_2)}{m_1 + m_2} \tag{3.16}$$

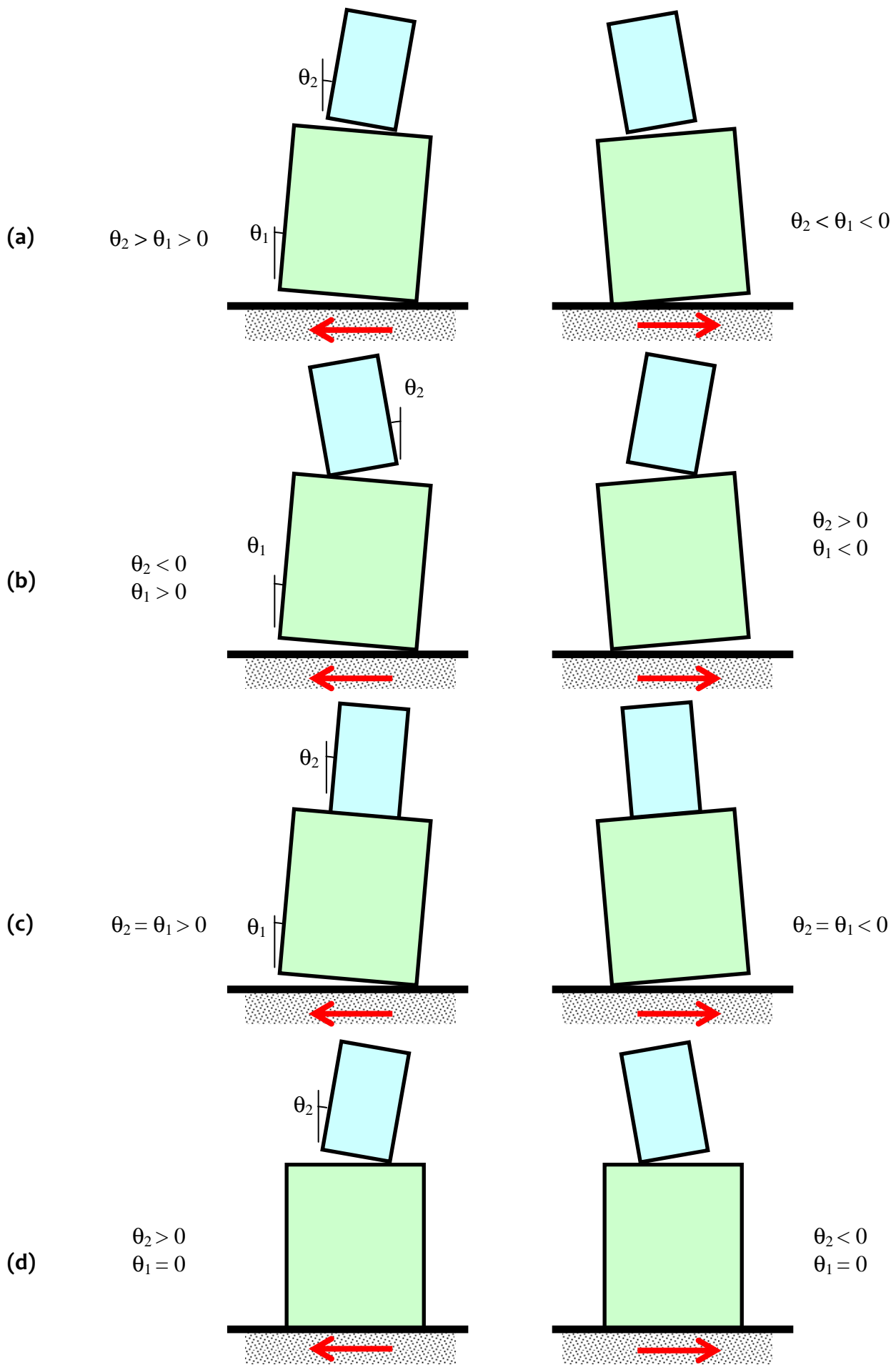
**(b) Equations of Motion**

The equations of motion are derived by Lagrange's Method for rocking of the two-block system. The kinetic energy of the system is

$$KE = KE_1 + KE_2 = \frac{1}{2} \sum_{i=1}^2 (m_i v_G^2 + I_G \dot{\theta}_i^2), \tag{3.17}$$

and potential energy by

$$PE = PE_1 + PE_2 = \frac{1}{2} \sum_{i=1}^2 (m_i h_G g). \tag{3.18}$$



**Figure 3.16:** Possible rocking modes of 2-block system: (a) Mode 1: both blocks rock in same direction, (b) Mode 2: the blocks move in opposite directions, (c) Mode 3: Only bottom block rocks, and top one does not, and (d) Mode 3: Only top block rocks, and bottom one does not



In Eqs.(3.17) and (3.18),  $v_G$  denotes velocity of the centre of mass, and  $h_G$  height up to centre of mass from the bottom block, *i.e.*, block 1. Equating the two energies,

For Mode 1:

$$\begin{aligned} & (I_0 + m_2 l^2) \ddot{\theta}_1 + (m_2 l r_2 \cos \gamma_1) \ddot{\theta}_2 + (m_2 l r_2 \sin \gamma_1) \dot{\theta}_2^2 - m_1 g r_1 \sin(\theta_1 - S_\theta \theta_c) - m_2 g l \sin(\theta_1 - S_\theta \beta) \\ & = [(m_1 r_1 + m_2 l) \cos(\theta_1 - S_\theta \theta_c)] a_{eqbx} + [(m_1 r_1 + m_2 l) \sin(\theta_1 - S_\theta \theta_c)] a_{eqby} \end{aligned} \quad (3.19)$$

For Mode 2:

$$\begin{aligned} & (I_0 + m_2 l^2) \ddot{\theta}_1 + (m_2 l' r_2 \cos \gamma_2) \ddot{\theta}_2 + (m_2 l' r_2 \sin \gamma_2) \dot{\theta}_2^2 - m_1 g r_1 \sin(\theta_1 - S_\theta \theta_c) - m_2 g l' \sin(\theta_1 - S_\theta \beta') \\ & = [-m_1 r_1 \cos(\theta_1 - S_\theta \theta_c) + m_2 l' \cos(\theta_1 - S_\theta \beta')] a_{eqbx} + [m_1 r_1 \sin(\theta_1 - S_\theta \theta_c) + m_2 l' \sin(\theta_1 - S_\theta \beta')] a_{eqby} \end{aligned} \quad (3.20)$$

For Mode 3:

$$I_0 \ddot{\theta}_1 - M g R \sin(\theta_1 - S_\theta \theta_c) = -M R [a_{eqbx} \cos(\theta_1 - S_\theta \theta_c) - a_{eqby} \sin(\theta_1 - S_\theta \theta_c)] \quad (3.21)$$

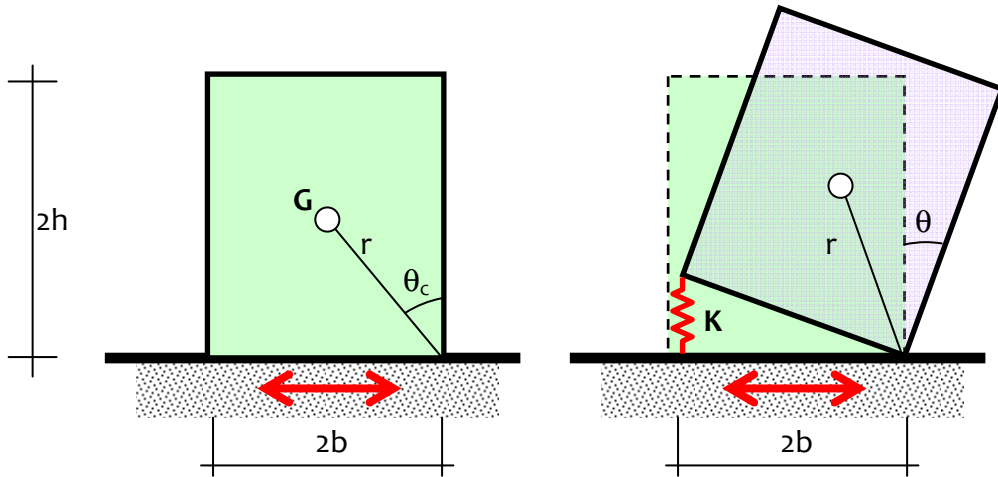
For Mode 4:

$$I_0 \ddot{\theta}_2 - m_2 g r_2 \sin(\theta_2 - S_\theta \theta_c) = m_2 r_2 [a_{eqbx} \cos(\theta_2 - S_\theta \theta_c) - a_{eqby} \sin(\theta_2 - S_\theta \theta_c)] \quad (3.22)$$

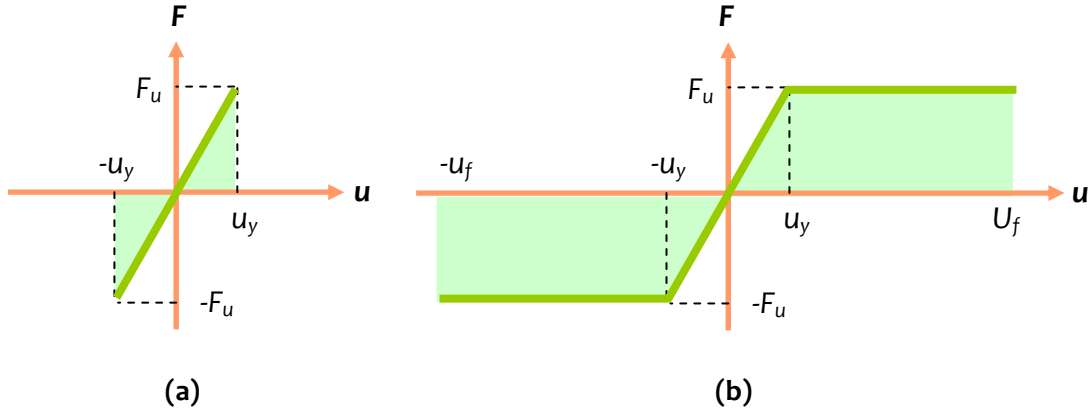
The above equations are highly nonlinear and depend on number of parameters. Numerical solutions are possible for known values of parameters, but *simplified design recommendations* are NOT available yet for use in design codes.

### 3.4 BEHAVIOUR OF ANCHORED FORCE-SENSITIVE NSEs

The decision to anchor force-sensitive NSE at its base to floor is based on its vulnerability in its unanchored condition. Two possibilities are expected in *anchored* force-sensitive NSEs, namely damage in the connection elements and in NSE itself, if the effective shaking of the NSE is violent. To prevent violent rocking of equipment, restrainers (hold-downs) are provided. Consider an anchored block in rocking motion (Figure 3.17). In this section, only horizontal excitation is considered at the base of the NSE. Anchors on each side of the block represent the net stiffness of all anchors on the side that uplifts. These anchors have finite strength  $F_u$ . The first simplified idealization of the behaviour of an anchor is *elastic-brittle behaviour* (Figure 3.18a); it is *linear elastic* until the ultimate strength  $F_u$  is reached, fractures thereafter, and the block rocks without any restraining force, like an unanchored one. The stiffness  $K$  of the restrainer is constant, until the anchor fractures. The second idealization of the behaviour of an anchor is *elastic-plastic behaviour* (Figure 3.18b). It is linear elastic until the ultimate strength  $F_u$  is reached, and deforms plastically thereafter until the fracture displacement  $u_f$  is reached; the block rocks without any restraining force thereafter, like an unanchored one.



**Figure 3.17:** Possible rocking mode of an anchored rigid block: Undeformed and deformed geometry of an anchored rigid NSE undergoing rocking



**Figure 3.18:** (a) *Elastic-brittle anchors*: Most anchor behaviour can be idealized as this; (b) *Elastic-plastic anchors*: Ideal anchor behaviour

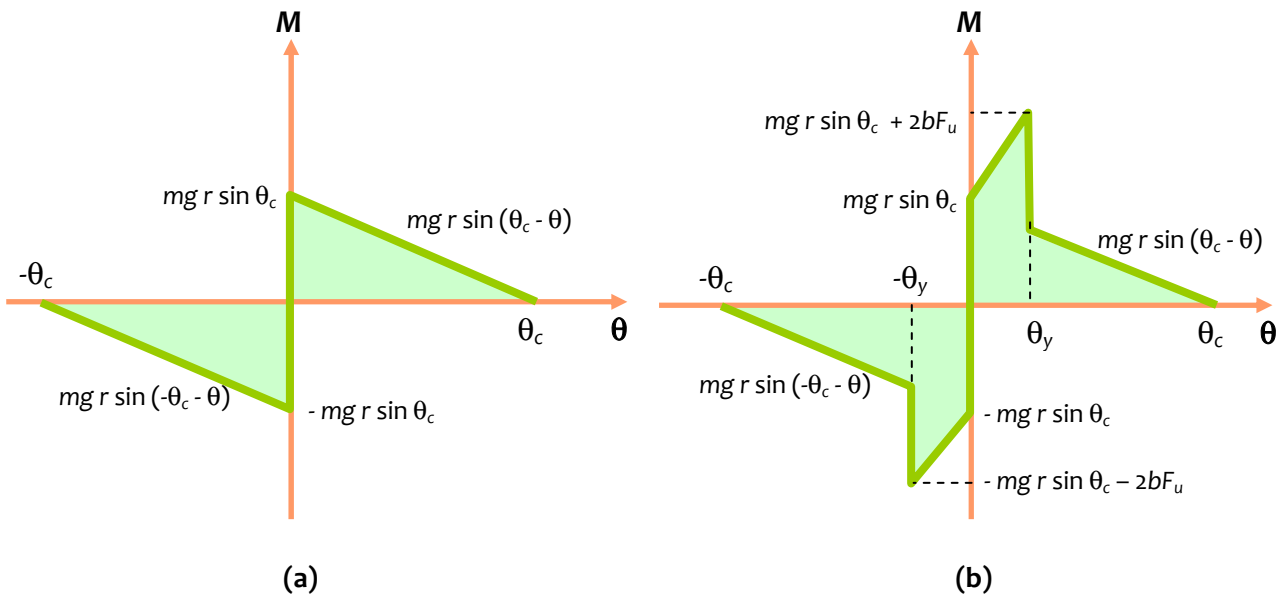
Figure 3.19a illustrates the moment-rotation relation of a free-standing NSE undergoing rocking, and Figure 3.19b that of an NSE with *elastic-brittle anchors*. Under horizontal excitation only, the equations that govern the rocking motion of an anchored block with mass  $m$  are:

$$\begin{aligned} I_0 \ddot{\theta}(t) + mgr \sin(-\theta_c - \theta(t)) + 4Kb^2 \sin\theta(t) &= -ma_{eqbx}(t)r \cos(-\theta_c - \theta(t)) \quad \text{for } \theta(t) < 0 \\ I_0 \ddot{\theta}(t) + mgr \sin(+\theta_c - \theta(t)) + 4Kb^2 \sin\theta(t) &= -ma_{eqbx}(t)r \cos(+\theta_c - \theta(t)) \quad \text{for } \theta(t) > 0' \end{aligned} \quad (3.23)$$

where  $I_0 (= 4mr^2 / 3)$  is the mass moment of inertia of the rectangular block, and  $r$  half the diagonal length. Expressing Eq.(2.23) in a compact form,

$$\ddot{\theta}(t) = p^2 \left[ \sin\{\theta_c \operatorname{sgn}(\theta(t)) - \theta(t)\} + \frac{3K \sin^2 \theta_c}{mp^2} + \frac{a_{eqbx}}{g} \cos\{\theta_c \operatorname{sgn}(\theta(t)) - \theta(t)\} \right], \quad (3.24)$$

in which  $p = \sqrt{3g/(4r)}$ . Eq.(2.24) is valid so long as anchors are present. If they fail, Eq.(3.24) reduces to Eq.(3.14), that of an unanchored block under horizontal excitation only.



**Figure 3.19:** Moment-rotation relation of rigid NSEs undergoing rocking: (a) *Unanchored NSE*, and (b) *Anchored NSE with elastic-brittle anchors*

Figure 3.19b shows the moment-rotation relation during the rocking motion of an anchored block. For rotation angle  $\theta(t) \leq \theta_y$ , energy is lost only during impact. Once  $\theta_y$  is exceeded, the anchor from the uplift side fractures and additional energy is dissipated equal to the area of the small triangle in the moment-rotation curve of the freestanding block. This energy is dissipated once, since in subsequent post-fracture oscillations the moment-rotation relation reduces to that of an unanchored block.

The transition from Eq.(3.23) to Eq.(3.13) is tracked through a fracture function  $f(\theta)$ . The finite ultimate strength  $F_u$  of anchor in conjunction with linear pre-fracture behaviour defines angle of rotation  $\theta_y$  that anchors yield at, and eventually fracture. From basic mechanics,

$$F_u = Ku_y = 2Kb\theta_y, \quad (3.25)$$

from which

$$\theta_y = \frac{F_y}{2Kb}. \quad (3.26)$$

Here, the fracture function  $f(\theta)$  is defined as

$$f(\theta) = \begin{cases} 1 & \text{for } |\theta(t)| \leq \theta_y \\ 0 & \text{for } |\theta(t)| \geq \theta_y \end{cases}. \quad (3.27)$$

With the help of this fracture function, after replacing  $K/m$  with  $(F_u/u_y)(g/W)$ , the pre-fracture and post-fracture equation of motion of the rigid block can be expressed as

$$\ddot{\theta}(t) = p^2 \left[ \sin\{\theta_c \text{sgn}(\theta(t)) - \theta(t)\} + \frac{3F_u g \sin^2 \theta_c}{Wu_y p^2} f(\theta) \sin \theta(t) + \frac{a_{eqbx}}{g} \cos\{\theta_c \text{sgn}(\theta(t)) - \theta(t)\} \right]. \quad (3.28)$$

In Eq.(3.28), the rocking response of anchored blocks is described by four parameters, namely the block slenderness  $\theta_c$ , the frequency parameter  $p$  (that includes size effect), the strength parameter  $F_u/W (= \sigma)$ , and the influence factor  $u_y p^2 / g (= q)$ .

The solution of Eq.(3.28) gives acceleration induced in anchored rigid blocks. This is dependant on geometric properties of the block and the strength and stiffness of the anchor. The ratio of maximum induced acceleration in the block and the peak support acceleration is called the component acceleration amplification factor  $a_p$ . A value of 2.5 is commonly recommended by design codes for acceleration-sensitive NSEs with flexible anchors. Further, when anchors with plastic deformation capacity are used, the peak response is reduced, which is accommodated in a component response reduction factor  $R_p$  (discussed in Chapter 4).

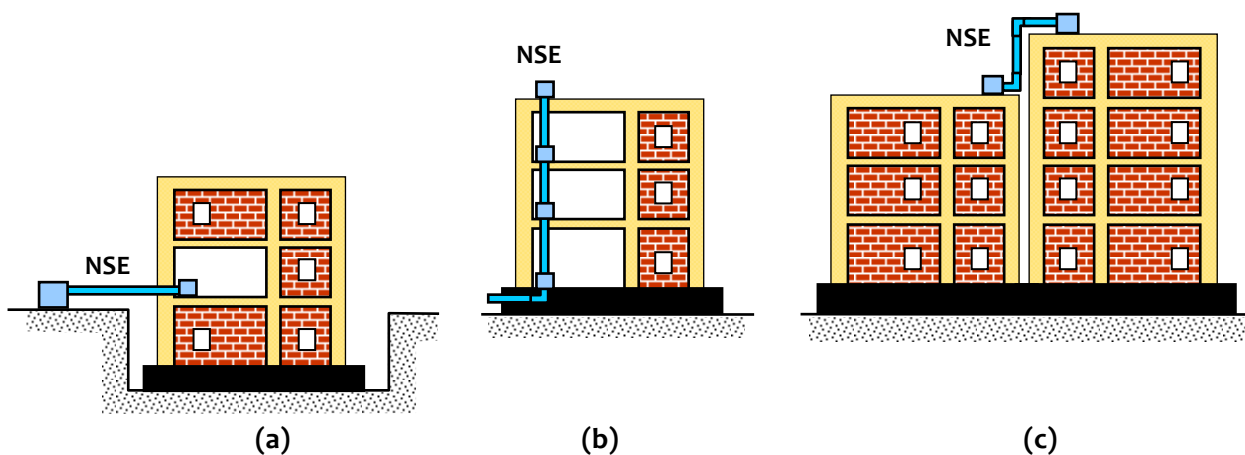
### 3.5 BEHAVIOUR OF DISPLACEMENT-SENSITIVE NSEs

NSEs subjected to *pulling and shearing hazard* can be at any elevation of the building and occurs when the relative displacement at the ends are not accommodated either by the connections or the NSEs. Based on the displacement restraint imposed by the SEs supporting the NSEs, different approaches are required to estimate this relative displacement and ways of accommodating the same. For the purposes of designing the connections between the NSEs and SEs and of accommodating the relative displacement, NSEs subjected to *pulling and shearing hazard* can be classified into three types, namely

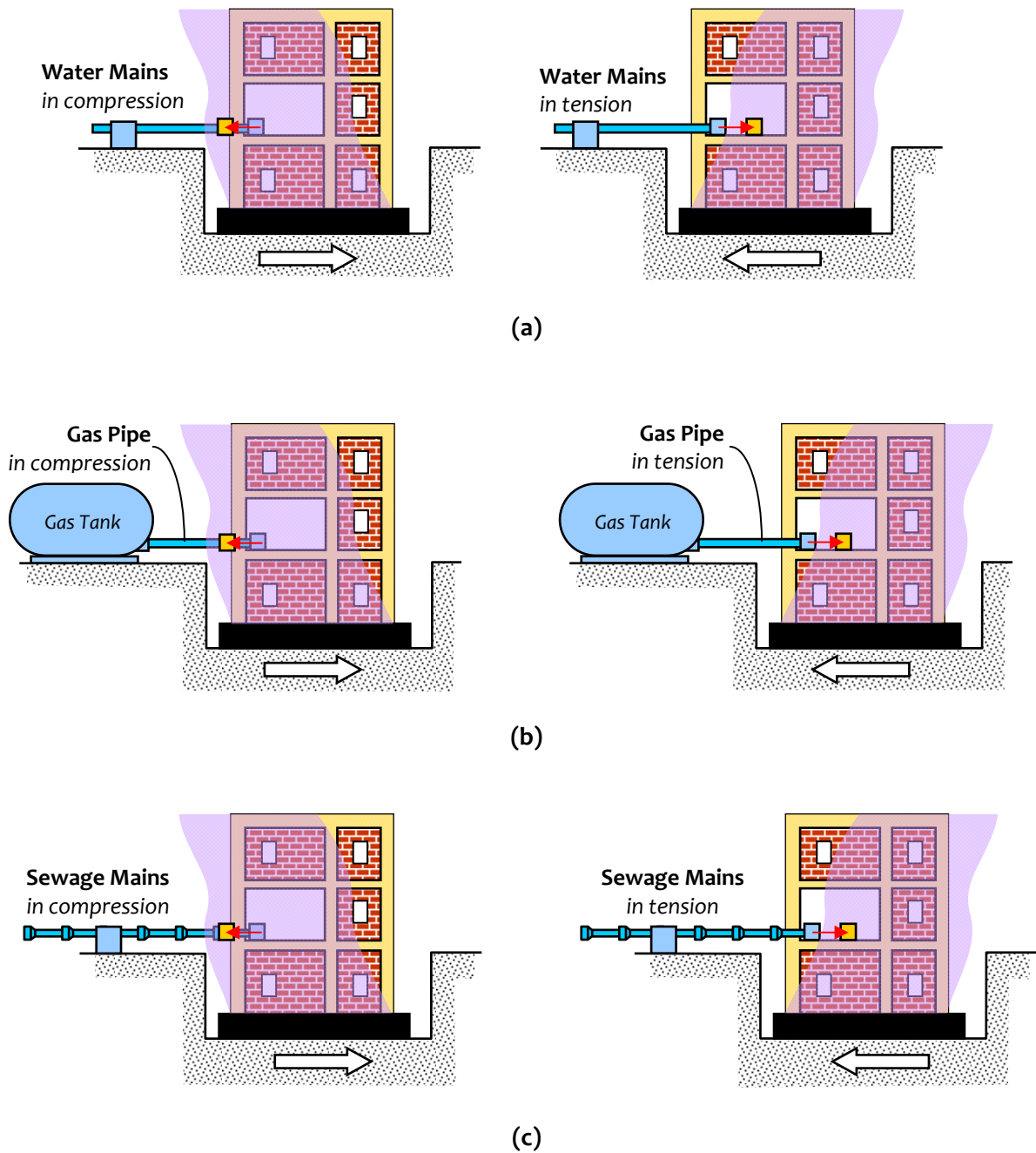
- (1) NSEs having relative displacement with respect to ground (Figure 3.20a),
  - (2) NSEs having Inter-storey relative displacement (Figure 3.20b), and
  - (3) NSEs having relative displacement between 2 buildings shaking independently (Figure 3.20c).
- Some of the typical examples are discussed in the following.

#### 3.5.1 NSEs having Relative Displacement with respect to Ground

Some lineal NSEs run between the outside ground and the building, but are connected to an upper elevation of the building in contrast to the base of the building. Examples of this type of NSE are *Water Mains* running from outside ground to the building (for normal use or for fire hydrant purposes; Figure 3.21a), and *Gas Pipes* laid between the building and a ground-supported large volume gas tank (placed at some distance away from the building; Figure 3.21b). In rare instances, *Sewage Mains* also are run from the outside ground to an upper elevation of the building (Figure 3.21c); normally, sewage lines go down to the lowest level of the building and exit through the base of the building to the outside ground. During earthquake shaking, the ground outside shakes independent of the building at the level at which the NSE is connected. Thus, the ends of the NSE are subject to differential shaking, implying that a relative *axial* deformation imposed between the ends of the NSE. This relative deformation can be large, if the building is laterally flexible. Tensile strains induced in the NSE can cause failure of the function of the sewage mains, if segmented pipes are used as Sewage Mains. Compressive strains in water mains can cause buckling of pipes, and thereby impede function. Design of NSEs and their connections to the SEs must find ways of avoiding these strains from being generated, by accommodating the relative displacement.

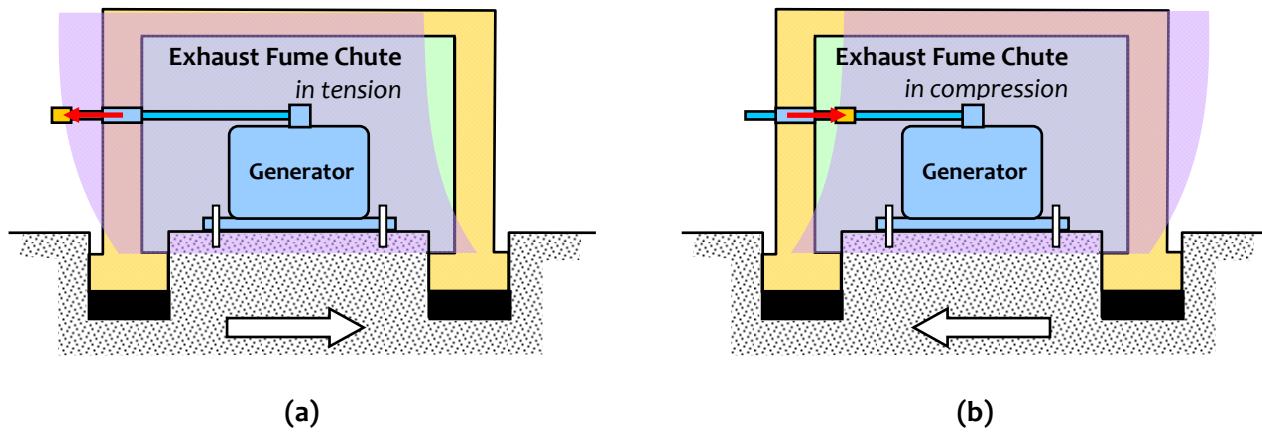


**Figure 3.20:** *Pulling and Shearing Hazard NSEs:* 3 types of relative deformations are imposed on the NSE, namely: (a) Relative Displacement with respect to Ground, (b) Inter-storey Relative Displacement, and (c) Relative Displacement between two buildings shaking independently



**Figure 3.21:** *Relative Displacement with respect to Ground:* Lineal NSEs need to sustain axial compression and tension strains without failure: (a) Water mains, (b) Gas pipes, and (c) Sewage mains

Another example of a lineal NSE of this kind is the *Exhaust Fume Chute* in generator rooms (Figure 3.22). The generator is normally anchored to its foundation that is directly constructed on ground. And, the exhaust fume chute goes from the generator to outside the generator room; it is supported by the wall of the generator room. The generator is relatively rigid, and the exhaust fume chute is flexible. Hence, when earthquake shaking occurs, the wall of the generator room shakes differentially from the generator, and all the relative deformation is accommodated only in the chute. Design of NSE must ensure that the exhaust fume chute is not restrained at the SE and accommodate the relative displacement.



**Figure 3.22:** *Relative Displacement with respect to Ground:* Exhaust fume chutes from diesel generators sustain axial compression and tension strains during earthquake shaking

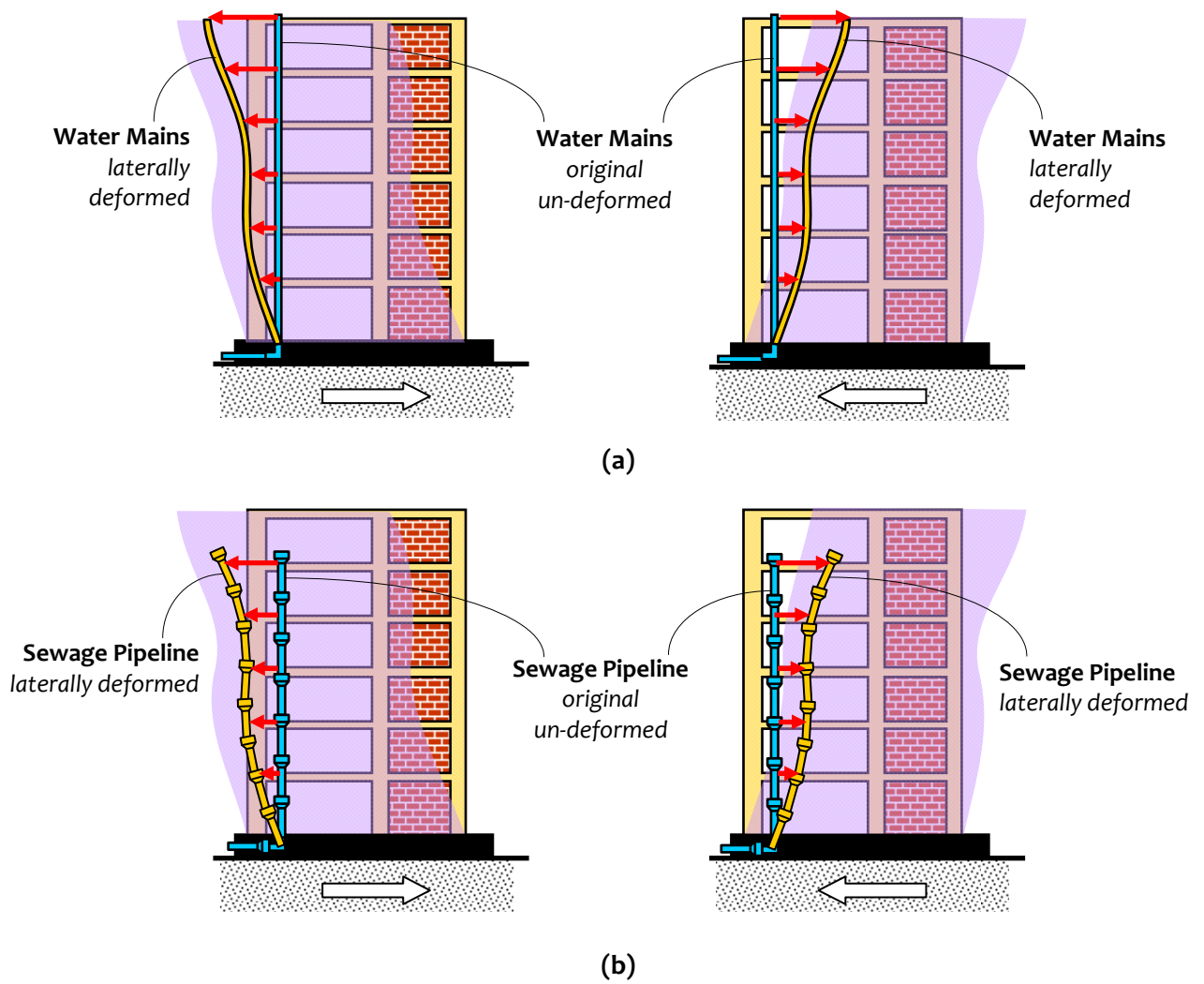
### 3.5.2 NSEs having Inter-storey Relative Displacement

Some NSEs run through the full height of the building (*e.g.*, façade stone or glass, and water pipes and sewer pipes), and some occupy the whole of a single storey (*e.g.*, French glass windows). Since these NSEs are supported by the floor slabs, columns and walls at different levels, they are subjected to relative deformation within each storey. The NSE needs to be capable of accommodating this deformation imposed on it by the adjoining SEs within each storey (Figure 3.23a). When segmented ceramic pipes are used for sewage transport, the inter-storey drift can cause rupture of the sewage lines (Figure 3.23b), which is a loss of function as well as second order disaster. Manufacturers of segmented sewage pipes also indicate the maximum lateral drift that the pipe joints can be subjected without leakage. Design of these sewage lines should verify this as part of the design of the NSE.

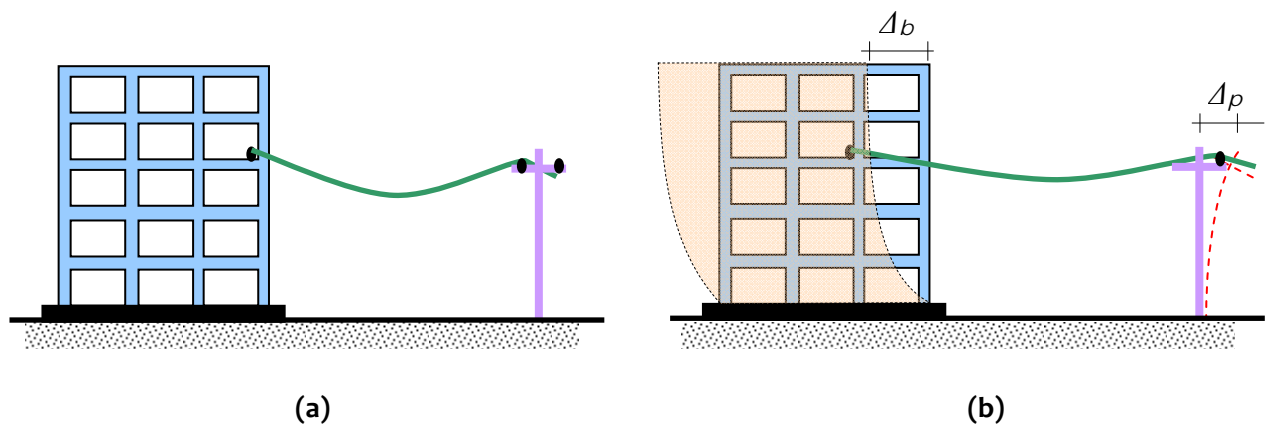
### 3.5.3 NSEs having Relative Displacement between Two Items Shaking Independently

Many buildings have expansion joints or seismic joints in them, thereby separating the buildings into parts that freely shake during earthquake ground motions. In many of these buildings, lineal NSEs are continued from one part of the building to the adjoining one. Examples of such lineal NSEs include (a) electric power wires and cables (Figure 3.24), (b) water pipelines, (c) gas pipelines in hospital and laboratory buildings, (d) air-conditioning ducts, (e) chemical pipes in industrial environments, (f) hazardous and chemical waste pipelines, and (g) in some instances, sewage pipelines. While these items are normally carried from one part of the building to the other at the same level, in some instances, the NSEs are continued from a certain level (in height) of one part of the building to a different level in the adjacent part.

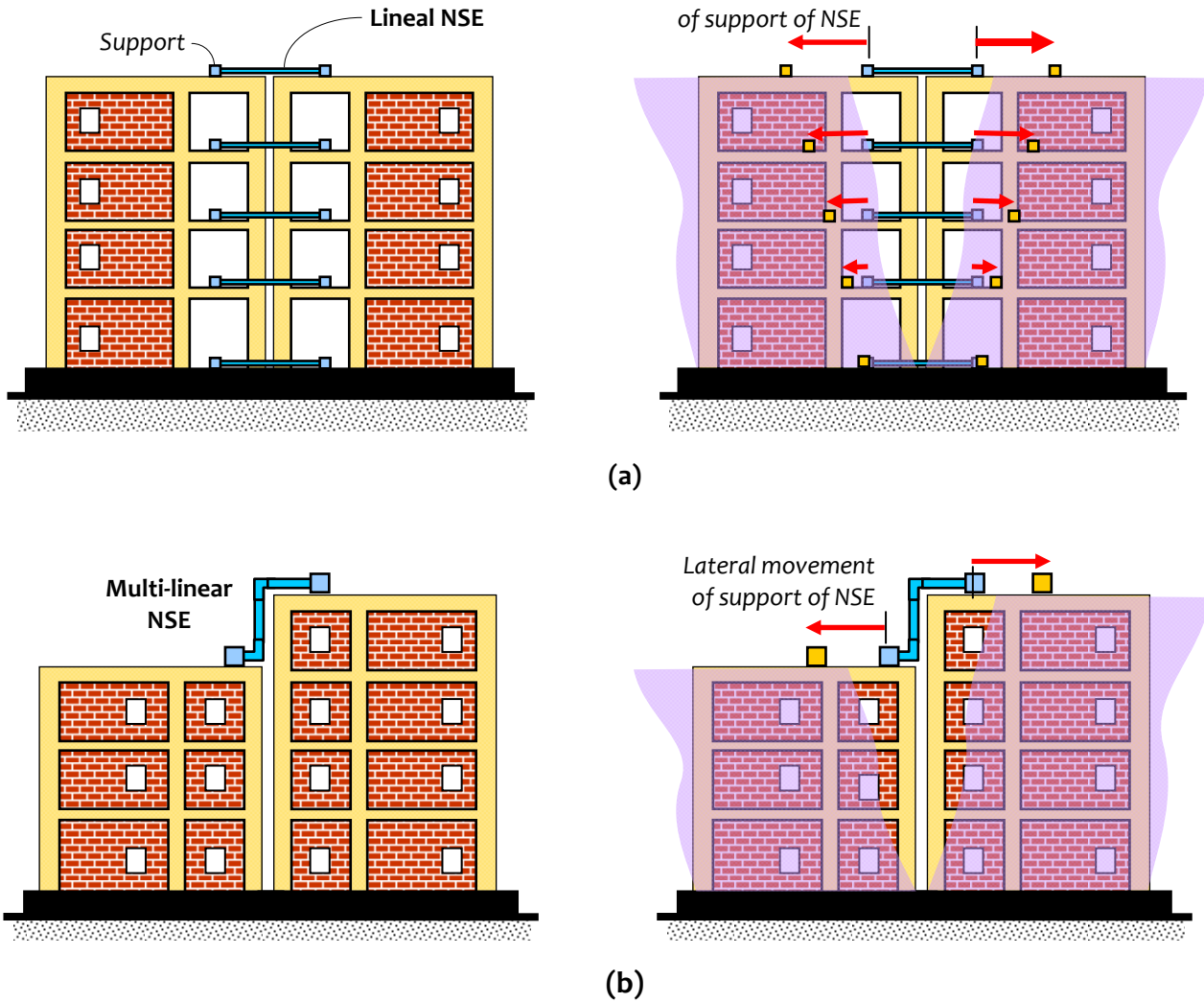
Differential movement occurs at ends of lineal NSEs that span across to adjoining parts of the building. Design of these NSEs and their connections to SEs needs to accommodate these relative deformations that occur between the two portions of the building during earthquake ground shaking (Figure 3.25), and thereby prevent failure of NSEs and other secondary effects.



**Figure 3.23:** *Inter-storey Relative Displacement: Lineal NSEs need to sustain lateral translational strains without failure: (a) Water pipelines, and (b) Sewage pipes*



**Figure 3.24:** *Cable wire connected between building and pole: (a) Initial position, and (b) Extreme position of building and pole causing maximum tension in cable*



**Figure 3.25:** *Relative Displacement between two items shaking independently on ground: Lineal NSEs need to sustain lateral and vertical displacements without failure: (a) connected to the same level on both parts of a building, and (b) connected to different levels on the two parts of a building*

### 3.6 EARTHQUAKE PERFORMANCE OF NSEs

The performance of NSEs may be assessed from:

- Performance evaluation of NSE employed in buildings and structures through post-earthquake investigations,
- Detailed experimental investigations of NSEs on shake tables, under different ground motions and performance parameters, or
- Rigorous analytical investigation of NSE under earthquake ground motion at the base of the structure or building on which NSE is housed, based on concepts of structural dynamics and through accurate modelling of interiors of NSEs along with that of the building and its SEs. Time history analyses of the primary-secondary system are performed under a suite of ground motions to understand the dependence of performance of NSEs on the motion characteristics.

Based on the above studies, attempts have been made to develop empirical equations for use in design codes to protect NSEs through the design of their connections to SEs.



Significant experimental research has been carried out on a number of NSEs. The conclusions from these investigations have been of immense help in tuning design code provisions [Chen and Soong, 1988; Villaverde, 1998]. On the analytical front, a number of challenges exist even now in modelling earthquake behaviour of NSEs, similar to that in the analytical modelling of SEs. For instance, damping in NSEs is considerably different from damping of SEs, and hence considerable difference exists in level of responses of NSEs as against those of SEs. Thus, commonly two methods of analysis are employed to obtain responses of NSEs, namely (a) Floor Response Spectrum (FRS) Method and (b) Complete Model Method. The FRS method is based on the results of numerous time history analyses. It predicts accurate results when, (a) mass of NSE is much lesser than the mass of SEs and (b) natural period of NSE varies considerable from the natural period of building. And, it fails when (a) dynamic interaction exists between SE and NSE, (b) NSEs are supported at multiple locations on SEs of the building, and (c) natural periods of NSEs are close to that of the building. Interaction between SEs and NSEs is not discussed in this book.

...



## Performance Expectation from NSEs during Earthquakes

### 4.1 EARTHQUAKE DESIGN PHILOSOPHY

*Normal buildings* (and hence SEs) are designed to undergo elastic behaviour (with no damage) under *force-type loadings* that appear on them, e.g., dead, live and wind loads. But, the same normal buildings are designed to undergo *inelastic behaviour* (with ductile damage) under *displacement-type loading* imposed by the earthquake ground shaking. If these displacement actions in SEs are to be realized, and if NSEs are secured snugly to the SEs, then the NSEs may be damaged. The severity of damage in NSE depends on the level of ground shaking and behaviour of SEs. Hence, expected performance levels should be discussed of SEs and NSEs, which are intended to be earthquake-resistant. Thus, *performance-based design* and *post-earthquake performance assessment* of both SEs and NSEs draw prominence to ensure that both the building and its contents behave as designed during expected earthquake shaking.

*Earthquake-Resistant Design (ERD) Philosophy* that is currently agreed upon internationally for buildings requires that

- (a) *Minor (and frequent) earthquake shaking* is resisted with NO damage to SEs and NSEs;
- (b) *Moderate shaking* with MINOR damage to SEs, but SOME damage to NSEs; and
- (c) *Severe (and infrequent) shaking* with damage to SEs, but with NO collapse of SEs (to save life and property inside/adjoining the building).

But, over time, the above agreement is becoming insufficient for SEs of *critical & lifeline buildings* and for NSEs of both *normal buildings* and *critical & lifeline buildings*. Thus, a *REVISED ERD Philosophy* is required for *normal buildings* as

- (a) *Minor earthquake shaking* resisted with NO damage to SEs and NSEs,
- (b) *Moderate shaking* with NO damage to SEs and NSEs, and
- (c) *Severe shaking* with damage to SEs but with no structural collapse, and with *no permanent damage* to NSEs;

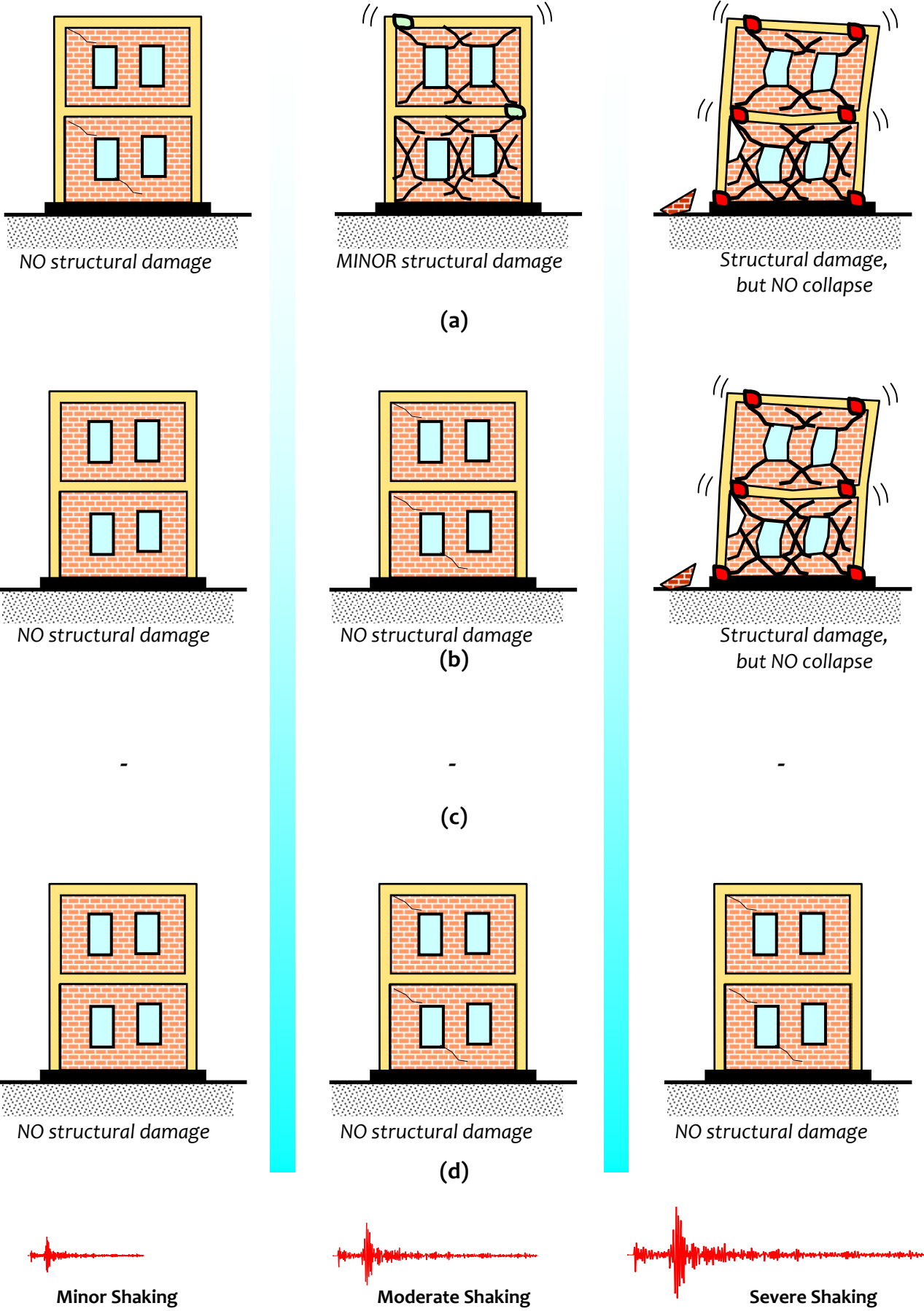
and for *critical & lifeline buildings* as

- (a) *Minor earthquake shaking* resisted with NO damage to SEs and NSEs,
- (b) *Moderate shaking* with NO damage to SEs and NSEs, and
- (c) *Severe shaking* with MINOR damage to SEs, and all NSEs *available for immediate use in the aftermath of the earthquake*;

In the *REVISED ERD Philosophy*, the expectation of earthquake performance of NSEs is relaxed to have *no permanent damage* in normal buildings as apposed to *be available for immediate use after the earthquake* in *critical & lifeline buildings*. Earthquake performance expectations are stringent of both SEs and NSEs in *critical & lifeline buildings*, in contrast to those in *normal buildings*. Table 4.1 and Figure 4.1 present a summary of performance expected of SEs and NSEs as per the above two ERD philosophies. In Table 4.1, '-' indicates that the ERD Philosophy is silent on the matter.

**Table 4.1:** Earthquake performance expectation of SEs and NSEs during different levels of earthquake shaking as per *CURRENT* and *REVISED* ERD Philosophies

Items	Earthquake-Resistant Design Philosophy	Building Type	Level of Earthquake Shaking		
			Low	Moderate	Severe
SEs	CURRENT	Normal	No damage	Minor damage	No collapse
		Critical and Lifeline	-	-	-
	REVISED	Normal	No damage	No damage	No collapse
		Critical and Lifeline	No damage	No damage	Minor damage
NSEs	CURRENT	Normal	No damage	Some damage	-
		Critical and Lifeline	-	-	-
	REVISED	Normal	No damage	No damage	No permanent damage
		Critical and Lifeline	No damage	No damage	No damage



**Figure 4.1:** *Seismic Design Philosophy for buildings (and hence SEs): (a) CURRENT Philosophy: Normal Buildings, (b) REVISED Philosophy: Normal Buildings, (c) CURRENT Philosophy: Critical & Lifeline Buildings, and (d) REVISED Philosophy: Critical & Lifeline Buildings*

#### 4.1.1 Expected Levels of Performance

Three *qualitative* ranges of earthquake behaviour of building structure (and hence the SEs) are stated, namely:

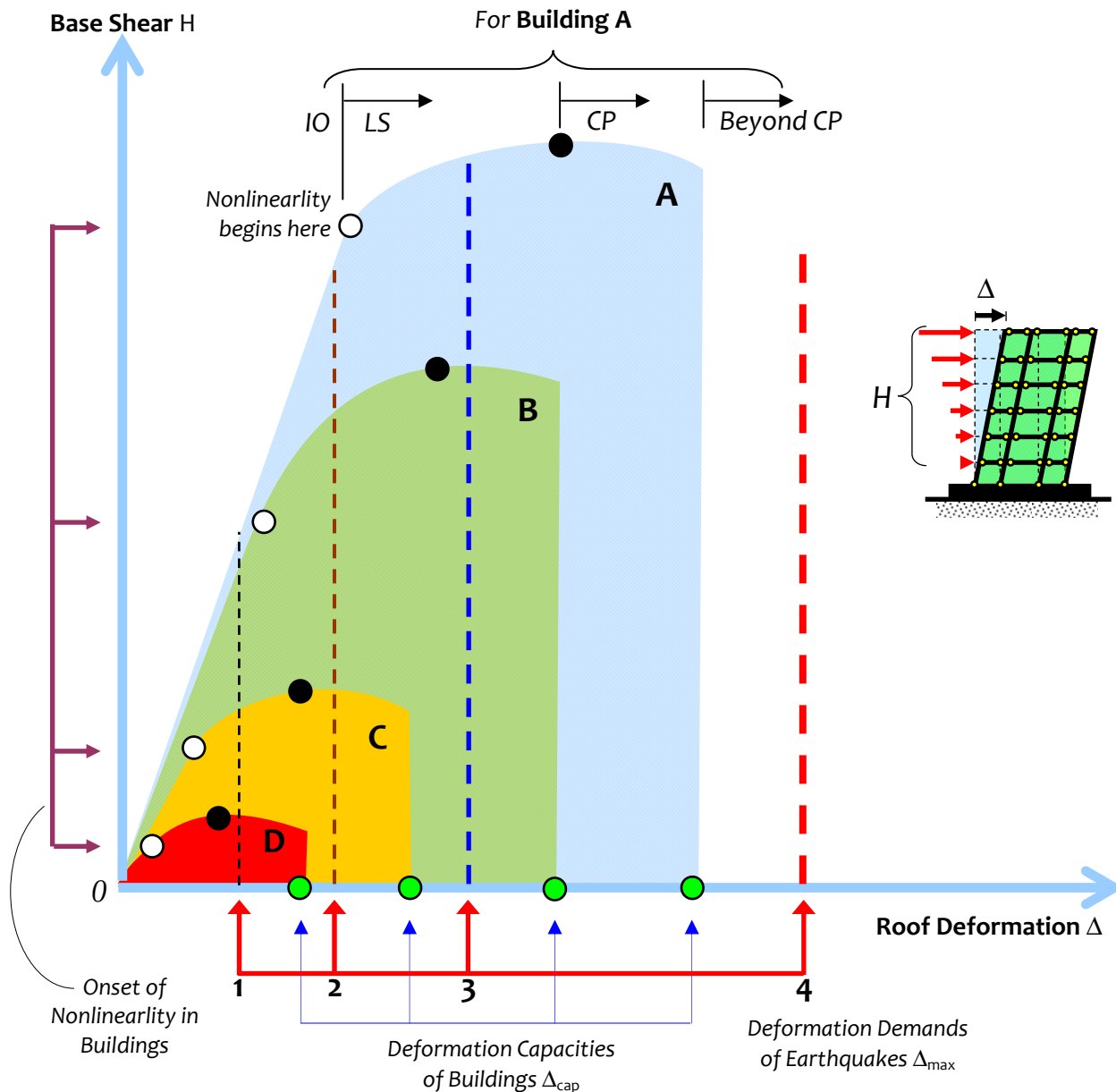
- (1) *Immediate Occupancy (IO) behaviour*: Building is shaken by the earthquake in its linear range of behaviour, and sustains no damage. It is available for immediate occupancy after the earthquake;
- (2) *Life Safety (LS) behaviour*: Building is shaken severely in its nonlinear range, sustains significant damage, but does not reach the state of imminent collapse and has some reserve capacity to withstand additional shaking. Detailed structural safety assessment is required to ascertain the suitability of the building for further use after the earthquake. If found suitable for retrofitting, building may be retrofitted and the building used thereafter; and
- (3) *Collapse Prevention (CP) behaviour*: Building is shaken severely in its nonlinear range, and sustains major damage. Consequently, it is left with little reserve capacity to withstand additional shaking, and is in the state of imminent collapse. It is not usable after the earthquake.

Many parameters (including characteristic of ground motions, structural system type and structural design method adopted) govern the overall behaviour of buildings during strong earthquake shaking. It is not easy to *quantitatively* define the desired behaviour level of a building, using any or some of these parameters that can be defined quantitatively. Also, there is no ONE acceptable, *quantitative* definition for the *IO, LS and CP* behaviour for estimating nonlinearities in SEs. Even now, some qualitative statements are made based on visual inspections, like *no damage, some damage, slight damage, minor damage, moderate damage, major damage and complete collapse*; again, without a quantitative definition, it is not easy to pinpoint and relate *precisely* these qualitative statements with the above behaviour ranges.

The above three ranges of expected earthquake behaviour of buildings is explained with the help of Figure 4.2. The figure shows the lateral load-deformation graph of different buildings A, B, C and D. For shaking intensity level 1, buildings A and B behave linearly; building C has small nonlinearity and building D large nonlinearity. For increased intensity of shaking of level 2, building A is still in the linear range, building B has small nonlinearity, building C large nonlinearity and building D collapses. Under further increase in intensity of shaking of level 3, building A enters the nonlinear range, building B has large nonlinearity, and buildings C and D collapse. In the extreme event of intensity of shaking of level 4, all buildings collapse. Thus, the behaviour of the four buildings with respect to the definitions of IO, LS and CP can be summarised as in Table 4.2. The performance is critically controlled by the deformation capacity and ductility of the buildings.

**Table 4.2:** Performance of four buildings under different levels of shaking intensities

Building	Shaking intensity level			
	1	2	3	4
A	IO	IO	LS	Beyond CP
B	IO	LS	CP	Beyond CP
C	LS	CP	Beyond CP	Beyond CP
D	CP	Beyond CP	Beyond CP	Beyond CP



**Figure 4.2:** Earthquake Behaviour of buildings: Four buildings A, B, C and D with different structural design strategies have different yield deformations and ultimate deformation capacities. Each of them responds differently under different levels of earthquake shaking that impose increased deformation demand on the buildings

The earthquake performance of an SE is determined together by the above three structural behaviour ranges AVAILABLE in the building and the intensity of ground shaking IMPOSED by the earthquake. Structural behaviour may be controlled reasonably by seismic design, but the intensity of ground motion is not in the control of the designers, even though reasonable estimates are being projected. The subject of Performance-Based Design of buildings is being researched, and the findings are not included yet in seismic codes of most seismic countries for design and construction of SEs. The current codes largely adopt equivalent lateral force-based approach to design SEs in new buildings and not the displacement-based approach required by Performance-Based Design concepts. Currently, displacement effects requiring ductility in the building (and hence SEs) are incorporated only indirectly in the structural design of SEs though prescriptive ductile detailing. Figure 4.3a shows these expected performance levels for SEs in normal buildings as per the currently stated ERD Philosophy. Also, the figure projects expected enhanced performance levels for SEs in critical & lifeline buildings; these are more stringent than those expected of SEs in normal buildings.

Discussion similar to the above is needed for performance-based design of NSEs also. Three qualitative ranges of earthquake behaviour are conceived for NSEs also, namely:

- (1) *Immediate Use (IU) performance*: NSE is shaken by the earthquake in its linear range of behaviour, and suffers NO damage; its function is not impaired due to the occurrence of the earthquake, and is available for immediate use after the earthquake;
- (2) *Dysfunctional State (DS) performance*: NSE is shaken severely in its linear range of behaviour, sustains NO damage, but cannot be used because ancillary units attached to it or needed along with it have failed or are being damaged during the earthquake shaking, and are rendered unavailable after the earthquake; and
- (3) *Damage or Collapse (DC) performance*: NSE is shaken severely in its nonlinear range of behaviour, and sustains damage.

As in the case of SEs, currently, many parameters (including characteristic of ground motions, nonlinear behaviour of the building, and intricate details of the NSE and its connection with the SE) govern the overall behaviour of NSEs during strong earthquake shaking. It is not easy to *quantitatively* define the desired behaviour level of an NSE, using any or some of these parameters that can be defined quantitatively. Also, there is no ONE acceptable, *quantitative* definition for the *IU, DS and DC* behaviour for estimating nonlinearities in NSEs. Even now, some qualitative statements are made based on visual inspections and functioning of NSEs after an earthquake, like *fully functional, temporarily dysfunctional and completely damaged*; again, without a quantitative definition, it is not easy to pinpoint and relate *precisely* these qualitative statements with the above behaviour ranges. Table 4.3 shows these three ranges of behaviour of SEs and NSEs.

The CURRENT ERD Philosophy requires that there is no damage to NSEs during minor shaking, but admits some damage in the NSEs during moderate shaking; it is silent about the performance expectation of NSEs under severe shaking. It is centred on the safety of NSEs, *i.e.*, structural integrity of equipments is the primary factor governing the design. It is based on the assumption that, if structural integrity and stability of the equipment are maintained, functional and operability is reasonably provided, although by no means assured [Porush, 1990]. Figure 4.3b (top figure with dashed line in Figure 4.3b) shows these expected performance levels for NSEs in *normal buildings*. But, considering the large investments being made in NSEs in typical building projects in India and abroad, this expected performance level for NSEs needs an upward revision in *normal buildings* also (middle figure with full line in Figure 4.3b). NSEs that are required to be operational during the aftermath of an earthquake are NOT addressed in the CURRENT ERD Philosophy, which focuses primarily on SEs and not on NSEs. The REVISED ERD Philosophy sets functional goals of critical NSEs from economic consideration and safety issues [FEMA 396, 2003]. This REVISED expectation is presented in Figure 4.3 of performance levels of NSEs in *critical & lifeline buildings*, which is consistent with the modern context of use of expensive NSEs. Figure 4.3 also presents a cross-comparison of the expected performance levels of *both* SEs and NSEs in *normal* and *critical & lifeline buildings*. Investment in a building project may be considered sound, ONLY IF both SEs and NSEs exhibit the above performances.

For a building subjected to the expected level of *severe* earthquake shaking, the limiting performance levels that should NOT be exceeded are:

- (1) *SEs of Critical & Lifeline Buildings*: SEs of these buildings should be within IO performance level. This will ensure that the building is available for immediate occupancy after the earthquake, without perceiving any threat to people in the event of aftershocks in the region; and
- (2) *NSEs of Critical & Lifeline Buildings*: NSEs of these buildings should be within IU performance level. This will ensure that the NSE is available for *immediate use* (IU) immediately after the earthquake. This will help the continuity of all the critical & lifeline building services to persons affected during the earthquake and requiring critical & lifeline services.

The target performance levels are listed in Table 4.4 for NSEs under severe earthquake ground shaking as per *CURRENT* and *REVISED* ERD Philosophies. A comparison of the target performance levels are listed in Table 4.5, for SEs and NSEs under severe earthquake ground shaking as per *REVISED* ERD Philosophy. Such performances expectations are discussed in literature for a list of NSEs [FEMA 274, 1997; Gillengerten, 2003].

**Table 4.3:** Behaviour ranges of SEs and NSEs under earthquake shaking

<i>Behaviour Type</i>	<i>Behaviour Ranges</i>	
	<i>SEs</i>	<i>NSEs</i>
<b>Linear</b>	Immediate Occupancy (IO)	Immediate Use (IU)
<b>Nominally nonlinear</b>	Life Safety (LS)	Dysfunctional State (DS)
<b>Severely nonlinear</b>	Collapse Prevention (CP)	Damage or Collapse (DC)

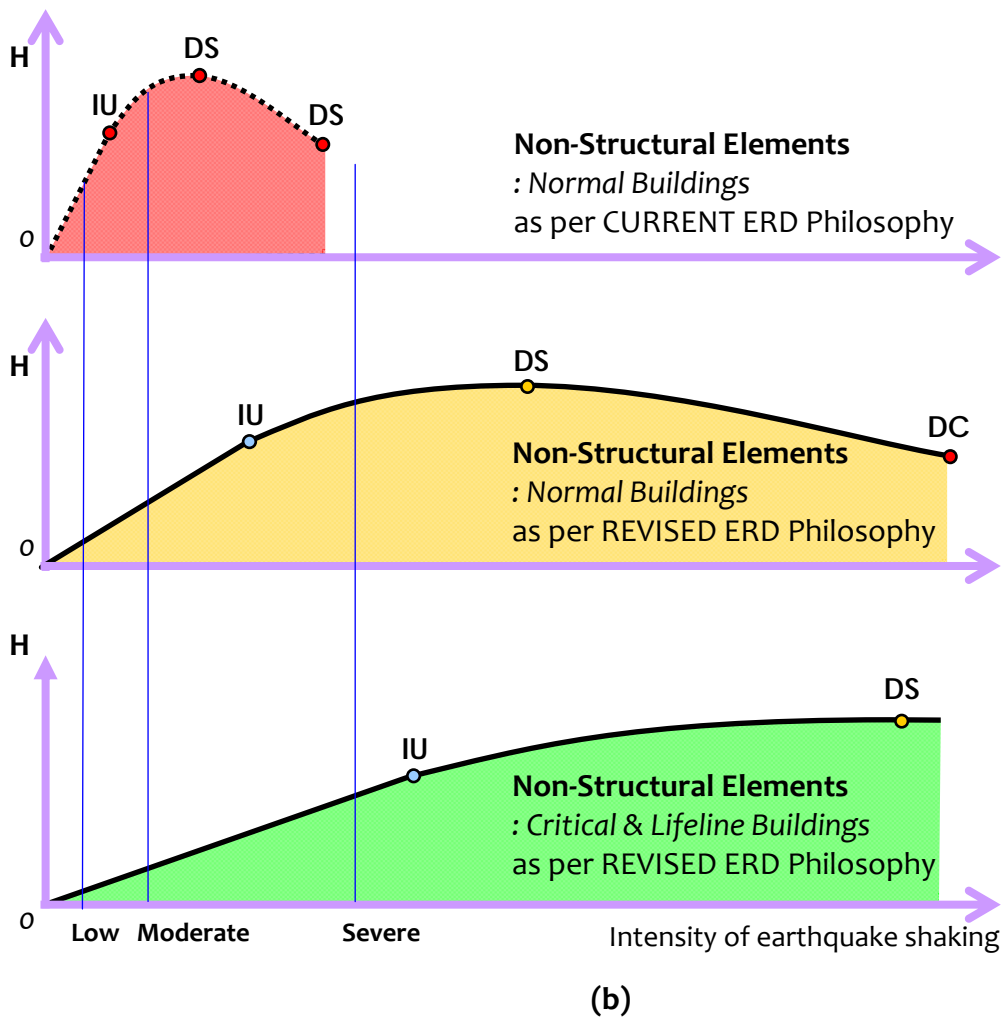
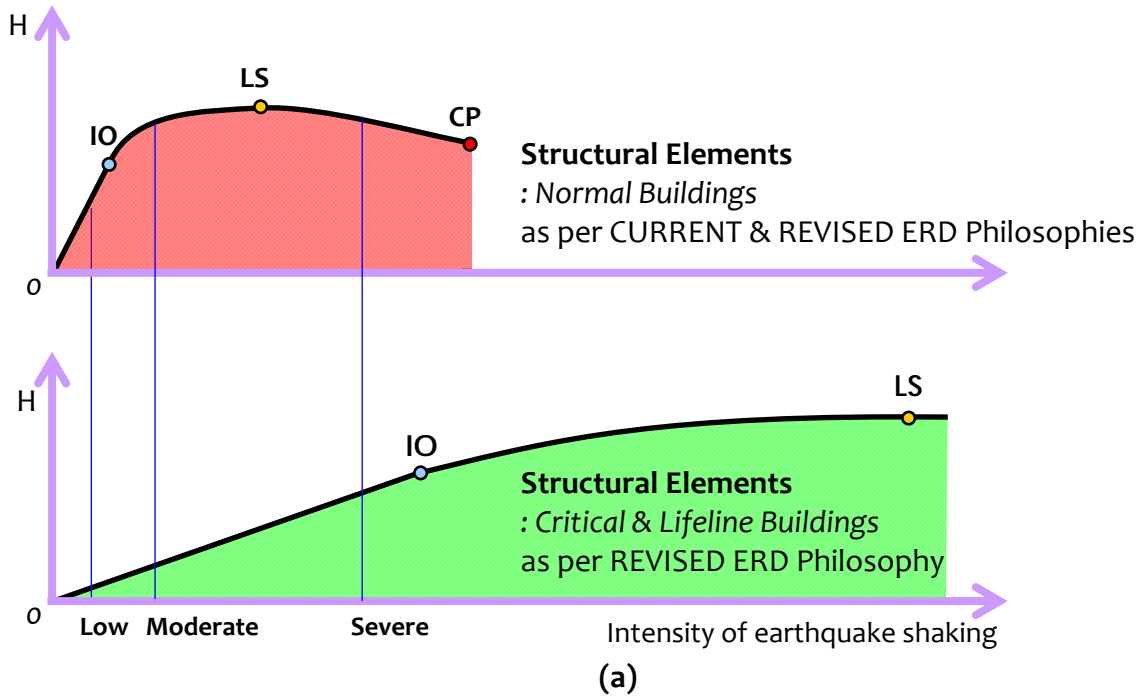
**Table 4.4:** Target performance levels of NSEs under *severe earthquake shaking* as per *established ERD* philosophy and *revised ERD* philosophy

<b>Building Type</b>	<b>Expected Performance Level</b>	<b>Expected Performance Level</b>
	<i>CURRENT ERD Philosophy</i>	<i>REVISED ERD Philosophy</i>
<b>Normal</b>	<i>No definition available</i>	Dysfunctional State (DS)
<b>Critical &amp; Lifeline Building</b>	<i>No definition available</i>	Immediate Use (IU)

**Table 4.5:** Target performance levels of SEs and NSEs under *severe earthquake shaking* as per *REVISED ERD* Philosophy

<i>Building Type</i>	<i>Expected Performance Level</i>	
	<i>SEs</i>	<i>NSEs</i>
<b>Normal</b>	Collapse Prevention (CP)	Dysfunctional State (DS)
<b>Critical &amp; Lifeline Building</b>	Immediate Occupancy (IO)	Immediate Use (IU)



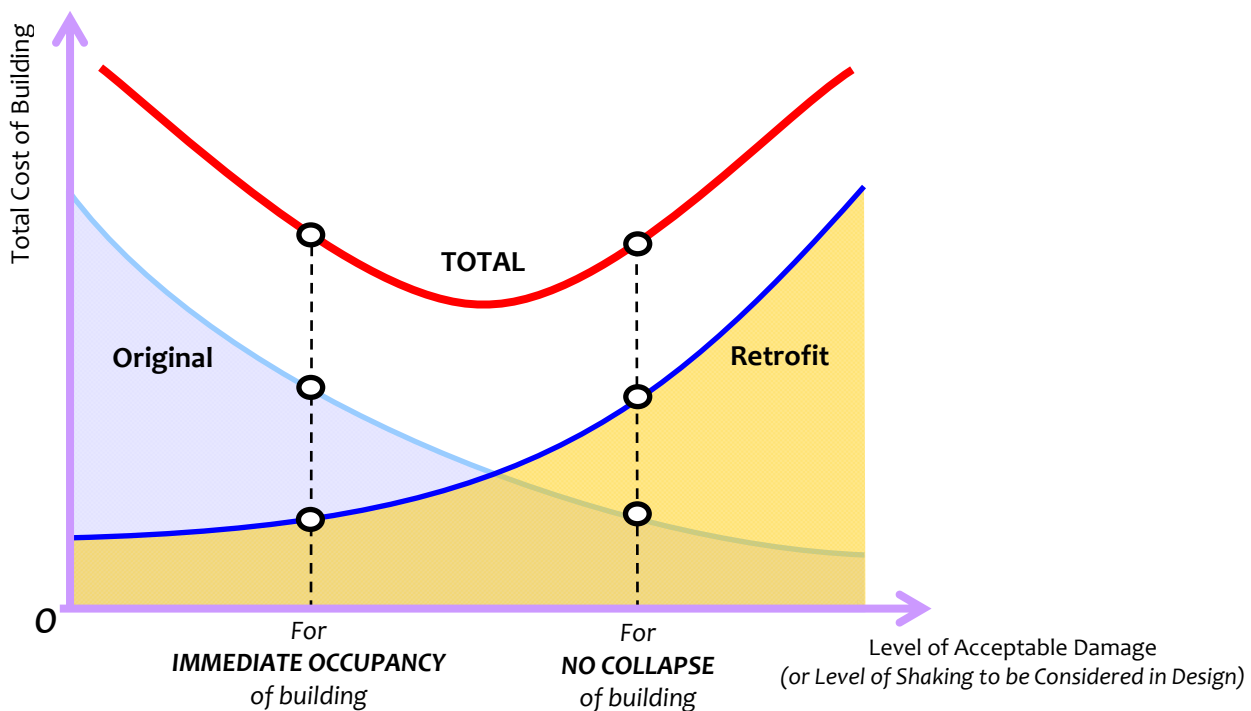


**Figure 4.3:** NSEs are required to be designed for higher levels of performance than SEs: Performance under three intensities (1-3) of earthquake shaking of (a) SEs, and (b) NSEs, in normal and critical & lifeline buildings

### 4.1.2 Levels of Shaking to be considered

While the above discussion is focused on setting the *qualitative* expectation for NSEs at three levels of shaking, namely *minor*, *moderate* and *severe* shaking levels (Figure 4.3), *quantitative definitions* are necessary of these three levels of earthquake shaking to undertake design of NSEs and their connections to SEs. For *force-sensitive NSEs*, this will mean the level of *accelerations* imposed by SEs on NSEs, and for *displacement-sensitive NSEs*, the level of *relative displacements* imposed by SEs at points over which NSEs are supported. Traditionally, these intensities of ground shaking are determined by seismic hazard assessment (SHA) at the specific site of the building; *deterministic* and *probabilistic* methods are employed by different countries. SHA offers *peak ground acceleration* and *distribution of spectral acceleration with natural period T of the building* at the site. Using this description of ground shaking, the *floor response acceleration spectra* are derived for *force-sensitive NSEs*, and the *relative displacement* between support points of NSEs for *displacement-sensitive NSEs*.

While determining quantitative levels of shaking to be considered, it may happen that even though the performance objective of IMMEDIATE OCCUPANCY and NO COLLAPSE of the building may seem to result in very different initial cost investments, there seems to be lesser difference in the overall lifecycle cost (Figure 4.4). This also suggests that in special structures (like *critical & lifeline buildings*), it may be prudent to invest more initially itself and derive sufficient advantage of the improved performance of the building and NSEs. In the long run, as a community becomes more prosperous, it is hoped that this approach will be taken for all buildings, and not just for *critical & lifeline buildings*.



**Figure 4.4:** Lifecycle Cost of Building Projects: Different performance expectations may not change the overall lifecycle cost

### 4.1.3 Safety from Primary and Secondary Hazards

As discussed in Chapter 2, two possibilities arise for earthquake effects on NSEs, namely *force-sensitive* and *displacement-sensitive effects*. Usually, one of these effects dominates, and hence these effects are called *primary* and *secondary* effects. The former effect is more dominant and the latter effect lesser; NSEs should be *safe against both effects*. The NSE and its connection with SEs should be first *designed for the primary effects* and then *verified to be safe against the secondary effects*. Some NSEs are both *force-sensitive* and *displacement-sensitive*, and need to be designed for effects of both *accelerations* and *relative displacements*.

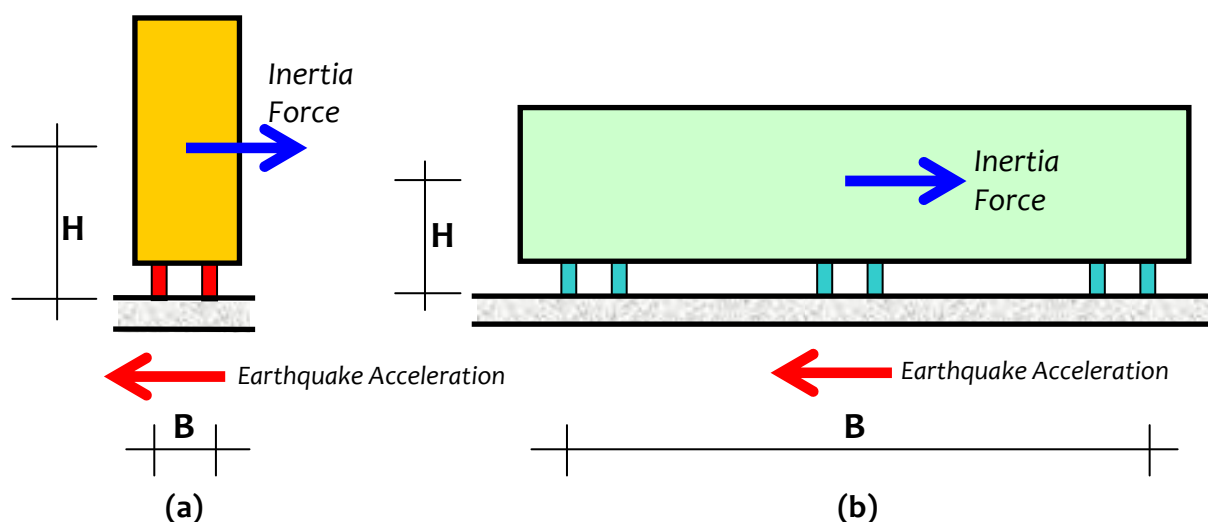
## 4.2 BROAD SUGGESTIONS FOR ARCHITECTS AND ENGINEERS

There are two effects of earthquake shaking on NSEs, namely: (1) Inertia effects arising from mass of NSE; NSEs tend to slide, rock and topple under this effect; and (2) Deformation effects arising from SEs on which NSE is mounted or within NSE itself; NSEs tend to stretch, shorten and shear under this effect. Architects and engineers need to address both these negative effects to protect NSEs.

*Stiff and massive* NSEs tend to be most sensitive to overturning *inertia forces* generated in them (Figure 4.5). This can be controlled by designing NSEs and their connections to SEs for such force-sensitive effects and made capable to resist the same without unexpected damage. This involves either

- (a) *Snugly connecting* the NSE to the SE and ensuring that inertia force of the NSE is transferred safely to adjoining SE, or
- (b) *Mildly restraining* the NSE from sliding and/or toppling and verifying that inertia force of the NSE is such that it does not cause any negative effect.

These NSEs can be secured by connecting them to *horizontal adjoining SEs*, to *vertical adjoining SEs*, or to *both horizontal and vertical adjoining SEs*. Virtually, all self-standing NSEs inside or on buildings are candidates to be examined for these inertia effects, and come under this first category requiring *force design*. Delicate and expensive contents of museums also are examples of this kind of NSE. Anchoring these NSEs to SEs causes additional forces on SEs, and the SEs should be designed to resist the forced imposed on them by the NSEs.

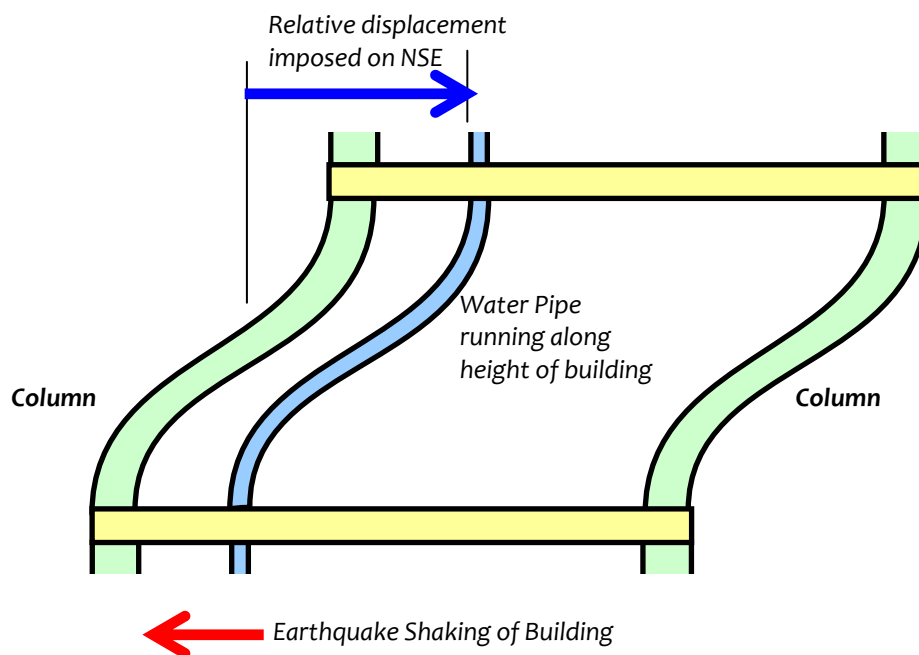


**Figure 4.5:** Unanchored force-sensitive NSEs:  $H/B$  ratio of the NSE determines the vulnerability of the NSE to toppling: (a) NSE with large  $H/B$  ratio is vulnerable to toppling; and (b) NSE with small  $H/B$  ratio less vulnerable

Flexible and long NSEs tend to be most sensitive to *displacement effects* imposed on them (Figure 4.6). The negative effects of this can be controlled by understanding the deformations expected in SEs on which the NSEs are rested for avoiding such displacement-sensitive effects and made capable to resist the same without unexpected damage. This involves providing

- (a) Flexible segments with adequate slack within the NSE adjoining one end of the NSE, to the SE to absorb freely (without any restraint) the relative movement expected between the NSE and SE, and
- (b) *Snugly restraining* the other end of the NSE to the adjoining SE to prevent rigid body movement of the NSE.

Like the force-sensitive NSEs, even these NSEs can be secured by connecting them to *horizontal adjoining SEs*, to *vertical adjoining SEs*, or to *both horizontal and vertical adjoining SEs*. Virtually, all lineal items (like pipes and electric/communication cables) that run from one floor to the other, from one part of a building to the other across the expansion/constriction joint, and from ground to the building, and supported at more than one point in buildings, are candidates to be examined for these displacement effects, and come under this second category requiring *displacement design*. Delicate and expensive glass façade panels employed in cladding building also are examples of this kind of NSE, which are supported by the SEs at multiple points and at multiple levels along the building height.

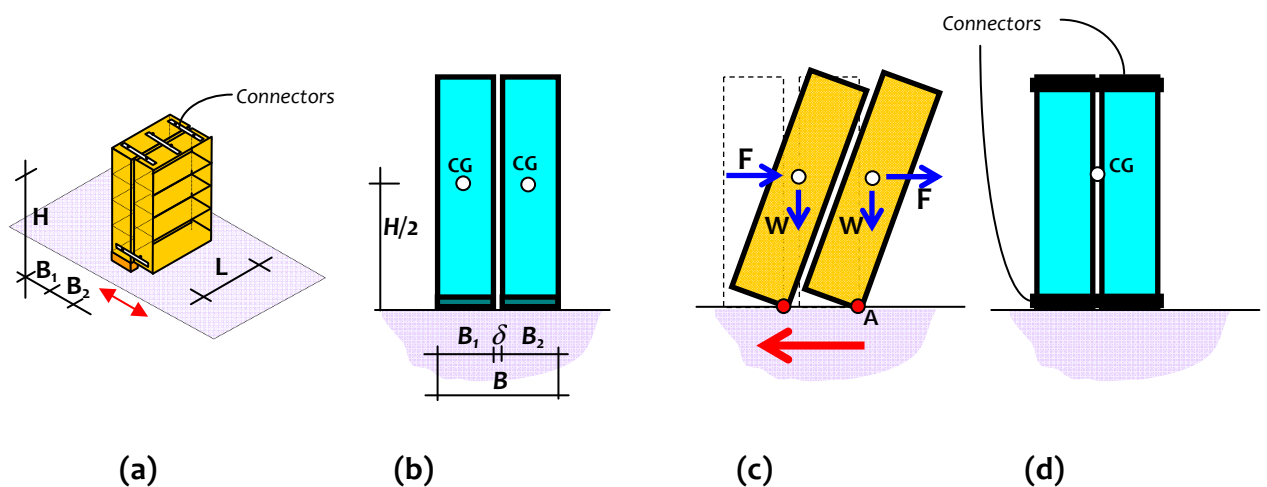


**Figure 4.6:** Rigidly anchored displacement-sensitive NSEs: SEs impose deformation on NSEs between their ends

#### 4.2.1 Strategies to Protect Force-Sensitive NSEs

The *strategy* to ensure safety of NSEs from *Sliding*, *Rocking* and *Toppling* is to (1) prevent it from sliding, AND (2) increase its restoring moment. Theoretically, increase in restoring moment can be achieved in many ways (e.g., increasing the *base dimension*; Figure 4.5). But, since most NSEs cannot be tampered with too much, the intervention to increase restoring moment *necessarily* seeks to connect the NSE to the structural system that carries all loads arising in the structure during earthquake shaking, along the load path to the foundation. The tying action can be with ropes/wires/cables, double-side sticking tapes, indirect hold-down methods, or small metallic flats/angles screwed/welded to the NSE and the structural system. The choice of the intervention depends on the *mass*, *geometric size*, *value*, *aesthetics* and *extent to which one can tamper with the NSE*. When it is not possible to tamper with it, the NSE can be encased in another shroud (without jeopardizing its functionality); in turn, the shroud is tied to the structural system.

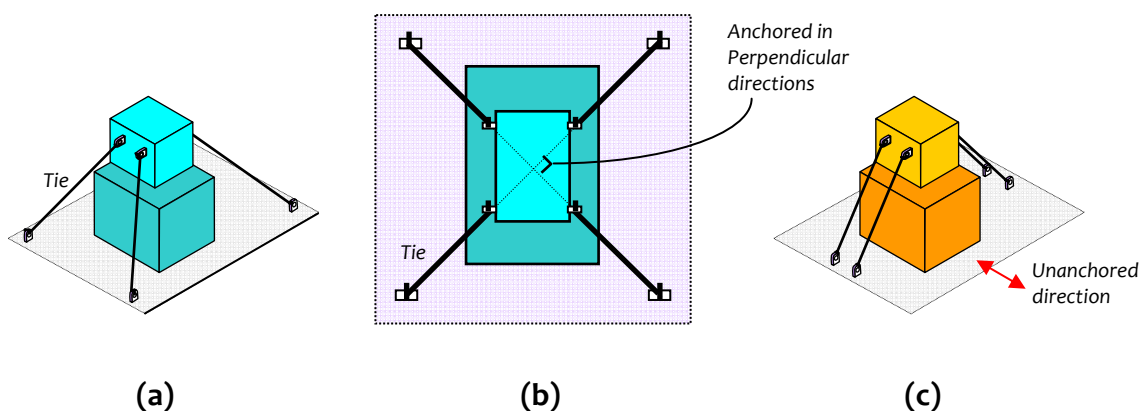
Objects placed next to the walls can be held back with the help of walls. But, those in the middle of the room need to be anchored only to the floor slab. An object topples when its centre of gravity moves out of plumb to its bottom *leeward* corner. Hence, sometimes, two adjacent objects (that are wide enough) can be tied together to increase stability against overturning by satisfying the condition (mentioned before) that the  $B/H$  ratio of the integrated object is more than 2 (Figure 4.7), so that the acceleration required is higher to move centre of gravity of the integrated object out of plumb of the bottom leeward corner of the object. The individual objects can be integrated with each other using metallic/wooden flats that can be welded, bolted/riveted or glued to the two objects (Figure 4.7a). The choice of the connector and method of connection depends on the factors stated earlier.



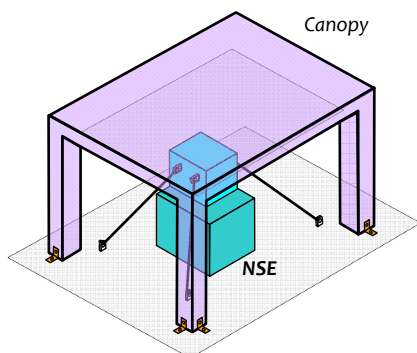
**Figure 4.7:** Unanchored Twin NSEs: Tendency to topple during earthquake shaking can be reduced by integrating them with stiff and strong connectors

When an NSE placed one over another NSE cannot be connected to each other, it may be necessary to tie the top object directly to the ground (Figure 4.8a). Here, the tying should be done symmetrically in two mutually perpendicular plan directions, by keeping the ties inclined in the two perpendicular plan directions (Figure 4.8b). The ties will resist inertia forces generated during earthquake shaking in all three directions in space. The choice of the connector and method of connection will depend on the factors stated above. When objects are not tied in both plan directions, they can swing in the unanchored directions (Figure 4.8c). The same is necessary for the bottom NSE too.

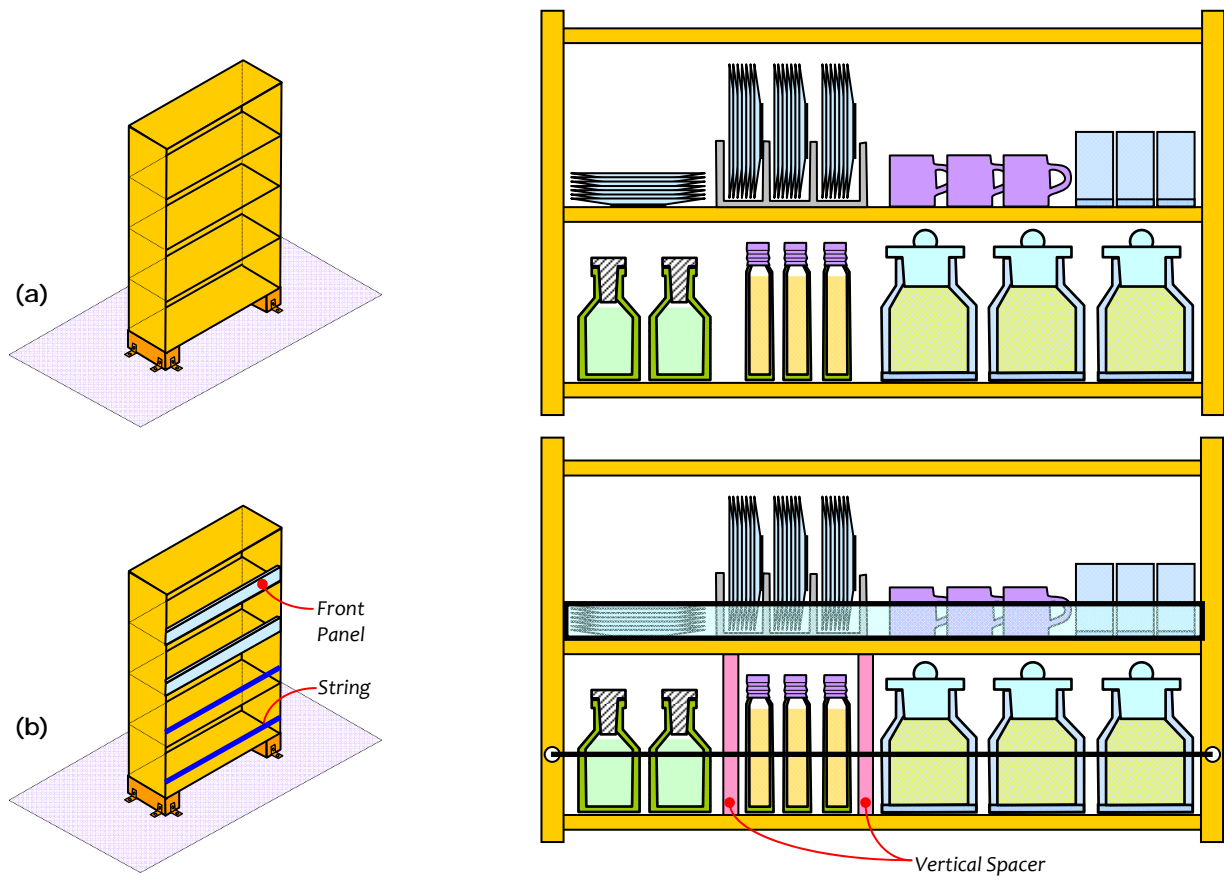
When an object is very precious or critical and is in the neighbourhood of objects that can fall on it, it may be given a second level of protection. This can be done by providing a canopy over it (Figure 4.9). Of course, the canopy itself must be made safe to take the impact of the falling object, by designing it to resist falling objects and preventing it from sliding or overturning during earthquake shaking. There are small or light objects that cannot be individually anchored, e.g., crockery on a kitchen shelf and glass bottles carrying chemicals on a chemical laboratory shelf (Figure 4.10a). For these objects, strategies are necessary to stack them in a container and design to hold back the container from toppling. Strings, front panel plates and vertical spacers are commonly used to hold back such items (Figure 4.10b).



**Figure 4.8:** *Direction of Tying NSEs:* (a), (b) In any two perpendicular plan directions, NSEs must be tied; this will ensure that the object does not swing unrestrained in any direction, and (c) Otherwise, the NSE remains unanchored along one direction



**Figure 4.9:** *Protection of NSEs against falling debris:* This can happen when objects are stacked at elevations higher than that of this NSE. Here, both the NSE and the canopy should be individually safe and anchored.



**Figure 4.10:** *Small and light NSEs that cannot be individually anchored:* Tendency to topple during earthquake shaking can be reduced if they can be held back by indirect means: situation (a) before intervention, and (b) after intervention

#### 4.2.2 Strategies to Protect Displacement-Sensitive NSEs

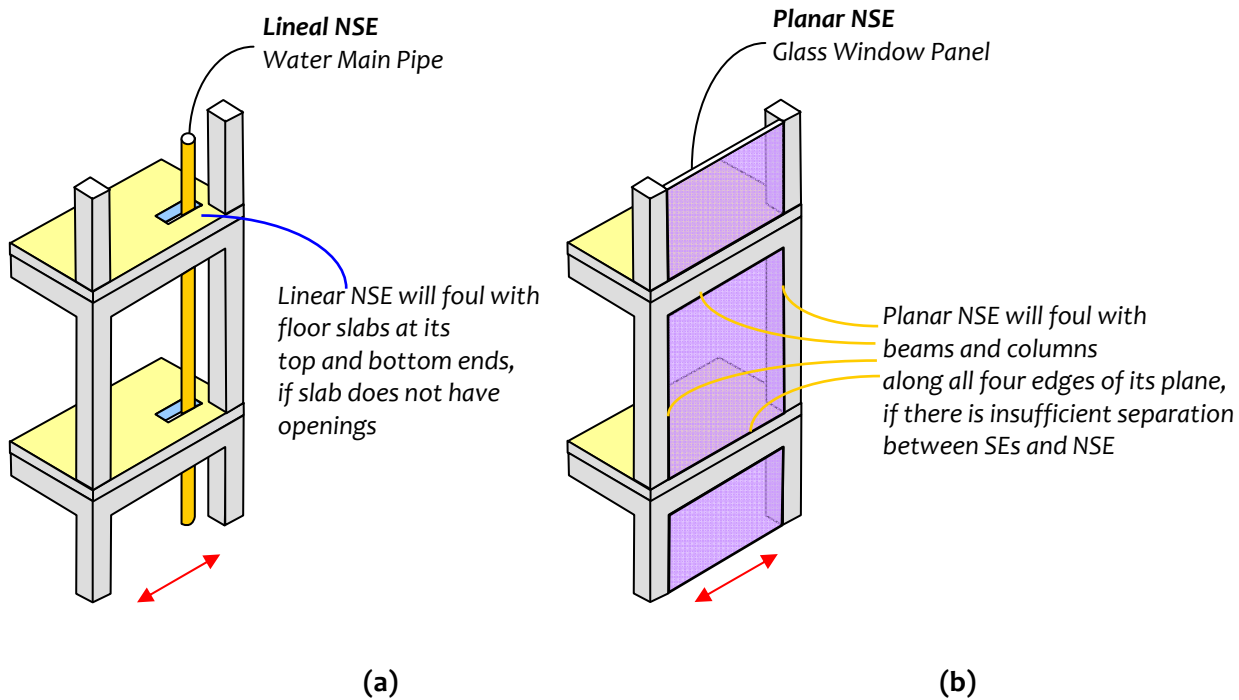
The *strategy* to ensure safety from *pulling and shearing hazards* is to prevent the objects from fouling with each other by providing a pre-determined separation/slack in them. Increase in separation can be achieved in many ways. Some NSEs cannot accommodate much displacement within themselves, and in these NSEs, the intervention to increase separation is largely through extra spaces between the SEs; the SEs in discussion can be part of the vertical or horizontal lateral load resisting system as discussed earlier in this chapter. Any intervention to increase the separation between SEs *necessarily* must seek to ensure that the NSE is supported at all times of the earthquake shaking.

Based on geometry, *pulling and shearing hazard* NSEs can be grouped into two types (Figure 4.11), namely *Lineal* NSEs (whose one dimension is much larger than the other two, *e.g.*, water mains and pipes) and *Planar* NSEs (whose two dimensions are much larger than the third, *e.g.*, glass window and façade panels). Lineal NSEs need to be supported at the ends, and need to accommodate the relative displacement imposed by the SEs between its ends. Planar NSEs are supported along the edges of its plane, and needs to accommodate the relative displacement imposed by the SEs along its edges.

The second requirement for protecting NSEs is to ensure that relative displacements between the ends of NSEs are accommodated through proper detailing between the NSE and the adjoining SE. *Flexible and slender* displacement-sensitive NSEs should be designed to accommodate the *relative displacements* generated between them and the adjoining objects and surfaces (Figure 4.12) by making provision for large oscillations without pounding, or extra slack in the NSE. Three types of relative displacement need to be accommodated in NSEs, namely

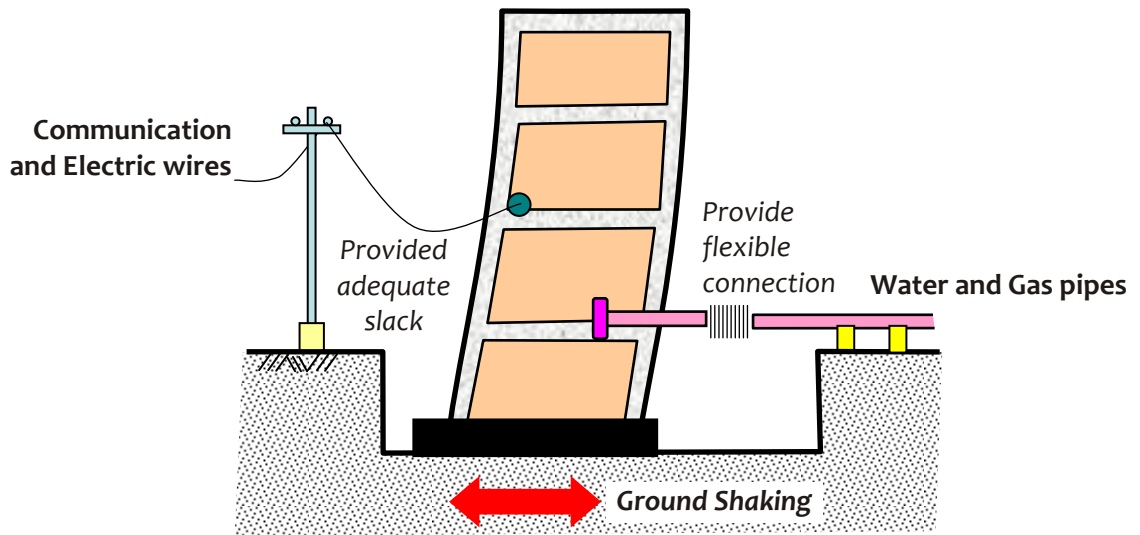
- (a) Relative movement between ends of NSEs connected between outside ground and oscillating building;
- (b) Relative movement between ends of NSEs connected between two different levels along the height of the same oscillating building; and
- (c) Relative movement between ends of NSEs connected between two adjoining oscillating portions of a building.

Electric lines, and fluid or gas pipelines entering the building from outside fall into the category (a) of *relative displacement design*. Such items when connected to buildings from the outside (either from the street or adjacent building) should be provided with adequate slack or flexible couplers to allow for relative displacement generated during earthquakes (Figure 4.12). If electric lines and fluid or gas pipelines run between two adjoining parts of a building, then they fall into category (c).

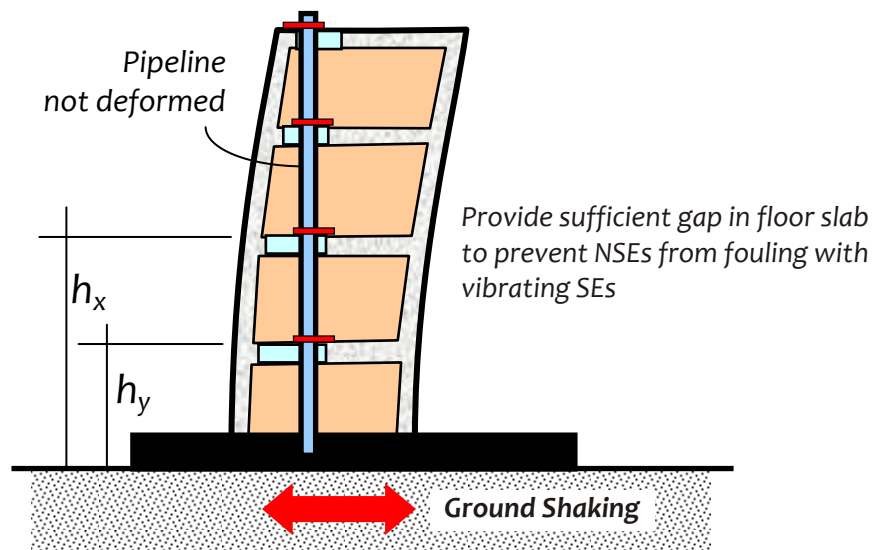


**Figure 4.11:** Types of displacement-sensitive NSEs: (a) Lineal NSE with possibility of fouling with the SE only at the two ends, and (b) Planar NSE with possibility of fouling with SE along the four edges of its perimeter

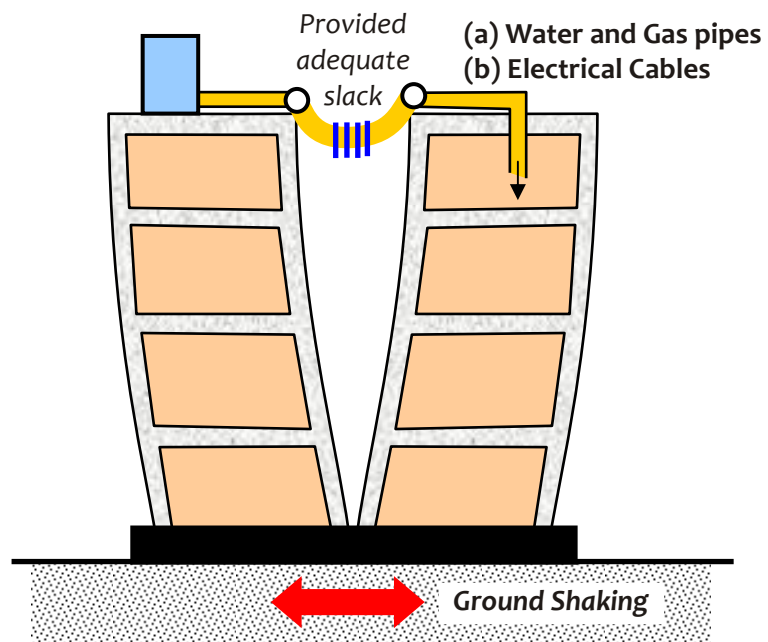




(a)



(b)



(c)

**Figure 4.12:** Protecting displacement-sensitive NSEs: Allow for free relative movement between ends of NSEs connected between (a) outside ground and building, (b) two different levels along the height of a building, and (c) two adjoining portions of a building

### 4.3 CLASSIFICATION OF PROTECTION STRATEGIES

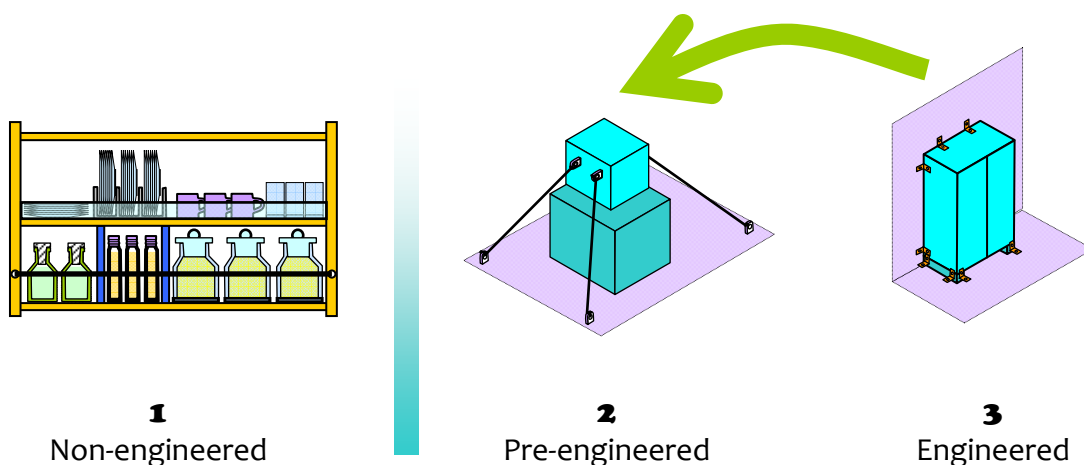
The evolution of protection of NSEs shows that three approaches are employed [FEMA 412, 2002; FEMA 413, 2004; FEMA 414, 2004; FEMA 577, 2007; FEMA E74, 2011; GHI-GHS-SR, 2009]. The first approach is based on *concept* (called *Non-Engineered Practice*), the second on *design calculations, limited experiments and experiences from past earthquakes* (called *Pre-Engineered Practice*), and the third on the formal *technical considerations* (called *Engineered Design Practice*). The philosophy of securing NSEs should identify these three approaches and work towards moving as many items as possible from the *engineered practice* (those require formal engineering design calculations) to *pre-engineered practice* (with calculations done *a priori* by the manufacturer) (Figure 4.13). For example, the fixtures required to secure standard cupboards should be pre-designed and manufactured along with the cupboard, and thus, be made a pre-engineered design practice. In general, all standardized items manufactured in large numbers should be secured using the prescriptive strategy by the help of provisions made to secure them easily during manufacturing. It may not be possible always to simplify the pre-engineered protection measures to non-engineered ones, especially when the NSE is massive and/or long. Such items should be identified and information on their protection be flagged off with non-engineered protection strategies (Figure 4.13).

#### (a) Non-Engineered Practice (Common Sense)

The simplest and commonly used strategy to secure *small and light NSEs* is practiced based on common sense. This strategy is largely applicable to objects that cannot be physically connected with the SEs, *e.g.*, small sized glass crockery, bottles on kitchen shelves and books on library shelves (Figure 4.10). The *Non-Engineered Practice* measures to secure the small NSEs and prevent a *collection of NSEs* from toppling together. For instance, a string or a front panel plate can be provided in racks or shelves to hold a *group* of crockery on cupboards, bottles on kitchen shelves or books on library shelves to prevent them from falling. Similarly, tying gas cylinders to walls with slack chains can prevent their toppling and rolling. A list of NSEs that can come under non-engineered strategy of protection is given in Table 4.6.

**Table 4.6:** Some examples of NSEs that require *Non-Engineered* and *Pre-engineered* Methods of securing against earthquake effects

<i>Method of Securing NSE</i>	
<i>Non-Engineered</i>	<i>Pre-Engineered</i>
Crockery plates and glasses on shelves; Books on shelves; Small items on supermarket shelves	Cup boards; Small Book Shelves; Televisions on small tables; Desktop computers; Side boards; Air Conditioning units; Refrigerators; Filing Cabinets



**Figure 4.13:** *Protecting strategies of NSEs:* More number of standardised NSEs should be brought under pre-engineered practice protection strategy, while information should be disseminated on simple effective non-engineered strategies

## (b) Pre-engineered Practice (Prescriptive Approach)

The second strategy is employed to secure *moderate sized NSEs* that are generic factory-made products and used commonly in houses and offices. This strategy is prescriptive, but the details of connection are arrived at based on calculations done by the manufacturer during development of the product, experiments conducted on prototype NSEs on shake tables, and observations made on their behaviour during past earthquakes. It is imperative that manufacturers foresee all possible on-site conditions before setting prescriptive standards for securing NSEs. In general, the prescriptive standards outlined by manufacturers are in the form of handouts and/or installation guides. Examples of such prescriptive practice to secure NSEs include anchoring accessories for wall mounted TV sets, wall mounted geysers in bathrooms, cupboards rested against walls or completely kept away from them, and electrical and plumbing lines running between floors of buildings or across a construction joint in a building. A list of NSEs that can come under pre-engineered strategy of protection is given in Table 4.6.

## (c) Engineered Design Practice (With Calculations)

The third strategy to secure *massive and/or long (one-of-its-kind) NSEs* has to be based on formal engineered design. Out of the three types of NSEs, namely *force-sensitive*, *displacement-sensitive* and *combined force-cum-displacement sensitive* NSEs, elastic force  $F_{NSE}$  appearing on an *force-sensitive* NSE is proportional to mass and acceleration experienced by mass of NSE, and can be written in terms of *weight*  $W_{NSE}$  and *horizontal acceleration coefficient*  $A_{NSE}$  of NSE as

$$F_{NSE} = A_{NSE}W_{NSE}. \quad (4.1)$$

The acceleration experienced by the NSE can be written in terms of the *horizontal acceleration*  $A_{floor,H}$  experienced by the floor on which the NSE rests, and a *component amplification factor*  $a_{NSE}$  that is dependant on the dynamic characteristics of the NSE. Hence,  $F_{NSE}$  can be re-written as

$$F_{NSE} = a_{NSE}A_{floor,H}W_{NSE}. \quad (4.2)$$

The component amplification factor  $a_{NSE}$  is affected by the net mass  $m_{NSE}$ , net stiffness  $k_{NSE,H}$  and  $k_{NSE,V}$ , and net damping  $c_{NSE,H}$  and  $c_{NSE,V}$  arising from items inside the NSE (Figure 4.14).

Again, the acceleration experienced by the floor on which the NSE rests can be written in terms of the *horizontal acceleration*  $A_{ground,H}$  experienced by the ground on which the building housing the NSE rests, and a *floor response acceleration modification factor*  $\eta_{floor}$  that is dependent on the dynamic characteristics of the building. Hence,  $F_{NSE}$  can be re-written again as

$$F_{NSE} = a_{NSE}\eta_{floor}A_{ground,H}W_{NSE}. \quad (4.3)$$

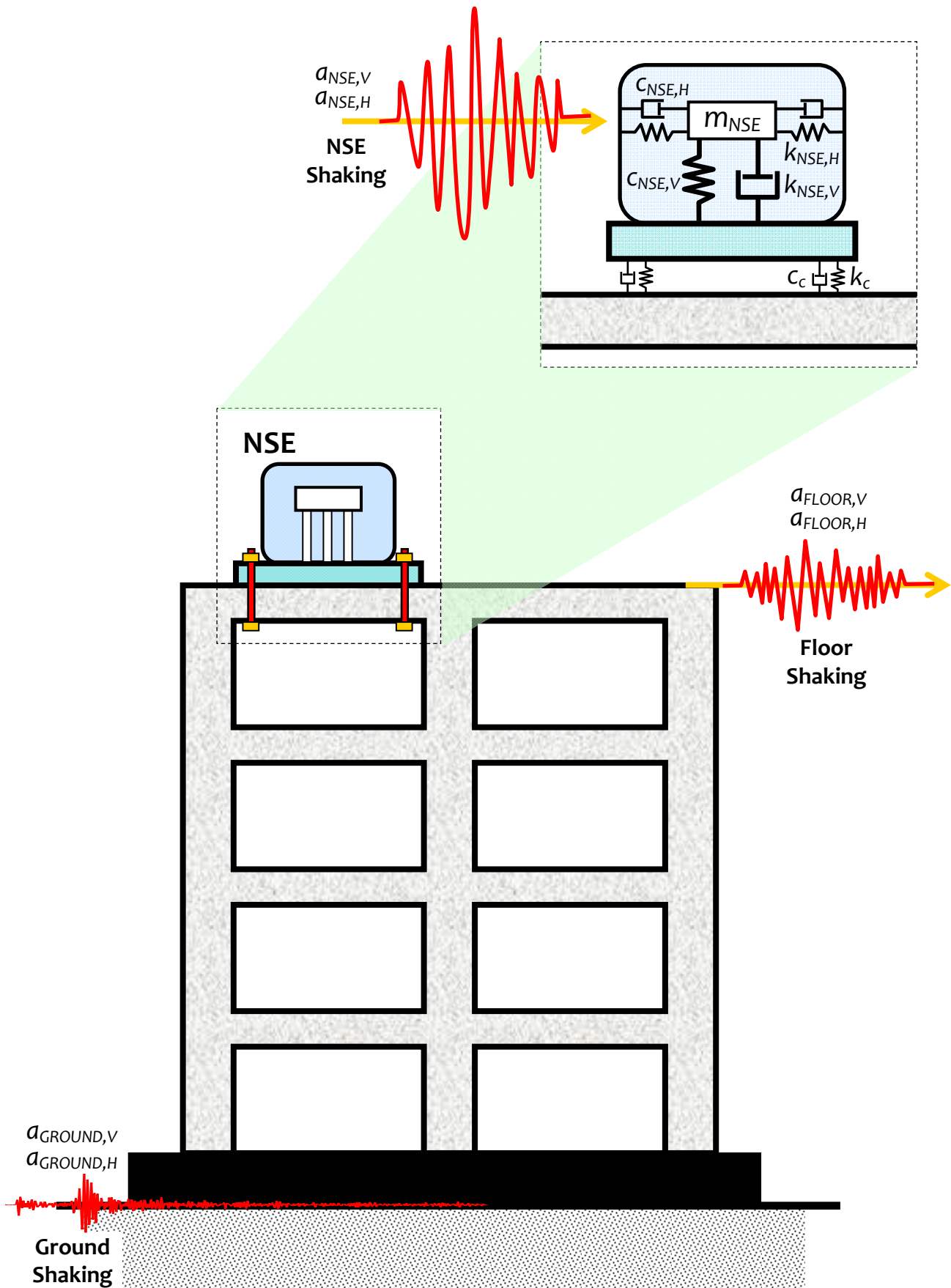
Some NSEs have capacity to sustain deformation without permanent damage or loss of functionality of NSE. In such cases, it is possible to reduce the *elastic force*  $F_{NSE}$  experienced by the NSE to an *inelastic force*  $F_{NSE,inelastic}$  through a *response reduction factor*  $R_{NSE}$  that reflects the ductility potential of the NSE. Therefore,  $F_{NSE,inelastic}$  can be written as

$$F_{NSE,inelastic} = \frac{a_{NSE}\eta_{floor}A_{ground,H}}{R_{NSE}}W_{NSE}. \quad (4.4)$$

The above discussion is based on *horizontal ground acceleration*  $A_{ground,H}$  only. When, *vertical ground acceleration* also is considered, it affects all factors related to the NSE and the building, namely  $a_{NSE}$ ,  $\eta_{floor}$  and  $R_{NSE}$ . The extent of these effects needs to be determined through detailed studies. Further, if effect of vertical acceleration  $A_{ground,V}$  also is considered on weight of the NSE, then expression for  $F_{NSE,inelastic}$  can be revised as

$$F_{NSE,inelastic} = \frac{a_{NSE}\eta_{floor}A_{ground,H}}{R_{NSE}} \left( 1 \pm \frac{A_{ground,V}}{A_{ground,H}} \right) W_{NSE}. \quad (4.5)$$

Various expressions are used in design codes for the floor response acceleration modification factor  $\eta_{floor}$ . NSEs requiring engineered strategies for protection are required to comply with design requirements discussed in Chapter 5.



**Figure 4.14:** Modelling of building (and SEs) and force-sensitive NSEs: Ground shaking results in shaking of floors on which NSE rests, and causes shaking of NSE

## International Code Provisions for Seismic Protection of NSEs

### 5.1 BASIC PROVISIONS FOR “ENGINEERED STRATEGY” OF SECURING NSEs

Chapter 4 classified strategies to protect NSEs into three sets, namely *non-engineered*, *pre-engineered*, and *engineered strategies*; this chapter deals with the third set only. Protection of NSEs by the “engineered strategy” is done in two ways, namely

- (1) *Floor Response Spectrum Method*, wherein the analysis of the NSE is delinked from that of the building. Estimates are made of the acceleration that are likely at the floor levels and used in the design of connections of NSEs to SEs; and
- (2) *Complete Model Method*, wherein the NSE and its connection with SE are modeled along with the building and the effect of shaking of NSE due to earthquake shaking is estimated from that.

International codes of practice have adopted the *Floor Response Spectrum Method*, because it is a simple method and requires less time to design connections between NSEs and SEs. Thus, this Chapter deals only with the *Floor Response Spectrum Method*.

Over the years, more effort has been made to ensure earthquake safety of structural systems than to protect NSEs under earthquakes shaking. Table 5.1 highlights the comparison of code provisions pertaining to SEs and NSEs [Reitherman, 1990]. Countries faced with high earthquake hazard have internalized experiences of earthquake safety of NSEs over the years. On the outer surface of the building, no objects are loosely placed on higher elevations at window sills, balconies or ledges of buildings, which can fall down from elevations, *e.g.*, flower pots are not precariously rested on ledges. In tall buildings of urban areas, this possibility is completely eliminated because of wind issues, *e.g.*, cantilever overhangs cause high wind forces on buildings and hence not employed anymore by architects of those countries. Also, most tall buildings do not have accessible balconies, and this further eliminates the possibility of placing any object (like a flower pot) informally on them by residents/users. Still, on the insides of buildings, heavy losses were incurred due to loss of NSEs and their function. This has led to formal review of earthquake performance of NSEs and development of design codes for the protection of NSEs. In this section, attempt is being made *only* to present *an overview* and *the intent of codes*, but not necessarily cover all code provisions worldwide available for protection of NSEs.

**Table 5.1:** Comparison of code provisions for SEs and NSEs [Reitherman, 1990]

S.No.	Item	SEs	NSEs
1	Applicability of Design provisions	Provisions applicable for all structural elements	Is conditionally applicable for NSEs with limited mass ratio (ratio of mass of NSE to mass of entire structure)
2	Performance Criteria	Provisions prescribed to prevent collapse or partial collapse of structures	Acceptable performance criteria not specified for majority of commonly used NSEs, <i>e.g.</i> , is damage to NSEs, present in a critical structure, allowed when subjected to severe shaking?
3	Ductility	Specific detailing requirement and <i>R</i> factors specified	<i>R</i> values used are ad-hoc, and are not based on scientific testing. Use of <i>R</i> value for design may increase likelihood of loss of operability of critical NSEs
4	Design Load Criteria	Designed for reduced loads based on deformation capacity of the structure	Loads are scaled down. Uncertainties exists whether NSEs will slide, rock or topple, under this reduced loading
5	Level of safety	Code compliance and good construction practices lead to very low chance of failure of structure	Code compliance and good construction may lead to better performance of NSEs; but it does not ensure that NSEs remain functional after an earthquake

### 5.1.1 Development of Code Provisions for NSEs

Review of development of design code provisions towards securing NSEs are available in literature [e.g., Mondal and Jain, 2005; ATC 69, 2008]. Important milestone lessons learnt from past earthquakes are listed in Table 5.2 on the development of provisions for securing NSEs, primarily in the Uniform Building Code (UBC) of USA. The evolution has been gradual of seismic design provisions for NSEs. For *force-sensitive NSEs*, the early provisions in the codes of USA were introduced in the Uniform Building Code (UBC) of 1937 [UBC, 1937] and improved in the subsequent versions of 1961, 1976, 1988, 1994 and 1997 [UBC, 1961, 1976, 1988, 1994 and 1997]. Later, the International Building Code (IBC) became the reference document for seismic design in USA. For *displacement-sensitive NSEs*, provisions were introduced in the Uniform Building Code (UBC) of 1991. Improved provisions for design were adopted in ASCE-7 published in 1995 [ASCE 7, 1995] and IBC (subsequent revisions of UBC 1997; IBC 2000, IBC 2003, IBC 2006, and IBC 2009) referred to provisions of ASCE 7 for design of displacement-sensitive NSEs. Provisions related to both force-sensitive and displacement-sensitive NSEs are discussed in the following paragraphs. Thus, seismic design codes [e.g., USA, New Zealand and Euro Code] recognize the importance of protecting both types of NSE.

**Table 5.2:** Development of design provisions for securing NSEs in buildings

S.No.	Earthquake	Lesson learnt	Key changes in design provisions
1	1906 San Francisco; 1925 Santa Barbara	Vulnerability of brick parapets and exterior walls	Provisions for NSEs included for the first time in <i>Appendix</i> of UBC 1927 Qualitative provisions required designers to bond and tie all NSEs to SEs to ensure that they act together
2	1933 Long Beach	Vulnerability of brick parapets and exterior walls	Shift from qualitative to quantitative provisions in <i>Appendix</i> of UBC 1935 NSE required to be designed for lateral force equal to fraction of its weight
3	1952 Baskersfield	Failure of URM brick parapets and exterior walls	Non-mandatory provisions from <i>Appendix</i> moved to main body of UBC 1961 Additional provision pertaining to design of anchorage for NSEs
4	1964 Alaska	Significant losses due to failure of NSEs including exterior precast wall panels	Provision for exterior panel connection incorporated in UBC 1967
5	1971 San Fernando	Failure of suspended ceiling systems, metal book shelves in libraries, water sprinkler systems and mechanical equipments	Design provisions of NSEs extended to storage racks, and suspended ceiling framing systems in UBC 1973 Provisions for mechanical equipment incorporated in UBC 1976 Importance factor explicitly stated for NSEs for the first time Increase in amplification of design force with vertical location of NSEs proposed by ATC-3-06 (1978) for mechanical & electrical components
6	1983 Borah Peak (Idaho, USA)	Fallen parapets, veneer and cracked chimneys	Provisions for design of NSEs extended for fire sprinklers and access floor systems in UBC 1985
	1984 Morgan Hill (California, USA)	Significant damage to ceiling, overturning of book shelves	
	1985 Mexico City	Window glass breakage, failure of piping systems, poor performance of heavy cladding	

<i>S.No.</i>	<i>Earthquake</i>	<i>Lesson learnt</i>	<i>Key changes in design provisions</i>
7	1986 San Salvador	Overturning of batteries and ceramic breakage	Provisions for design of NSEs extended for signage and billboards, major piping and ducting boilers, heat exchangers, chillers, pumps, motors, cooling towers in UBC 1988 Explicit requirement for non-rigid NSEs with increased $C_p$ (see Table 5.3) Reduction of seismic force by 2/3 for NSEs supported at grade
	1987 Whittier-Narrows (California, USA)	Failure of URM brick parapets and exterior walls Damage to partition walls, pipelines, chillers, mechanical equipments, library stacks, desktop computers Damage and temporary shutdown of elevators	
8	1989 Loma Prieta (California, USA)	Collapse of heavy plaster ceilings and ornamentations, falling of lighting grids, broken windows, store front glazing, and support fixtures Severe economic losses due to damage to water system 490 incidents of hazardous materials incident recorded	Issue of relative displacement of displacement-sensitive NSEs first addressed in UBC 1991
9	1991 Costa Rica	Failure of lights, ceiling fans and asbestos panel roofing Overturning of book cases & furniture Internal mechanical damage and anchorage problems	Increase in amplification of design force with vertical location of NSEs introduced by NEHRP 1994, UBC 1997, Euro code 8 (DD-ENV 1998-1-2) and IBC 2000 for mechanical & electrical components Maximum acceleration amplification expected at roof level is limited to 4 times design acceleration at base of building Concept of near fault effect, soil effect incorporated in design provision in UBC 1997
	1992 Landers (California, USA)	Failure of hung ceilings, light fixtures	
	1993 Guam; 1994 Northridge (California, USA)	Failure of elevator control cabinet Failure of spring mounted equipment, heavy furniture Failure of many museum pieces Extensive disruption to essential functions caused by NSE damage Failure of piping system 387 hazardous materials incident recorded during 1994 Northridge earthquake	
10	1999 Kocaeli (Turkey)	Collapse of storage racks, failure of light fixtures, piping system, stacked and stored material	Maximum acceleration amplification expected at roof level is limited to 4 times design acceleration at base of building in IBC 2006, ASCE/SEI 7-05
	1999 Chi-Chi (Taiwan)	Extensive failure of partition walls	
	2000 Napa	Failure of suspended ceiling tiles	
	2001 Nisqually (Washington, USA)	Loss due to NSE damage in excess 50% of total damage (about \$2 billion) Failure of ceilings, windows, store front glazing and book shelves	
	2004 Niigata (Japan)	Failure of glass, severe economic loss.	
11	2006 Hawaii (USA)	Fallen ceilings, light fixtures Significant damage to sprinkler system, exterior cladding, and piping systems	-

**(a) Design Lateral Forces for NSEs**

The evolution of some design provisions is presented in brief in Table 5.3 related to design lateral force provisions for design of connections of force-sensitive NSEs to adjoining SEs. In general, design provisions for NSEs consist of three distinct inputs, namely

- (a) Intensity of design ground motion at the base of building accounting for correction for local soil condition;
- (b) Amplification of ground motion intensity along the height of building; and
- (c) Component level amplification (due to flexibility of NSEs) and reduction (due to overstrength and ductility of the connection between NSEs and SEs).

**Table 5.3:** Evolution of *design lateral forces for force-sensitive NSEs in US codes*

Code & Section	Design Lateral Force for force-sensitive NSEs
UBC 1937 Section 2312	$F = CW_p,$ <p>where C was a coefficient equal to 0.05 for walls, towers and tanks, and 0.25 for exterior and interior ornaments and appendages, and <math>W_p</math> the weight of NSE</p>
UBC 1961 Section 2312	$F_p = ZC_pW_p,$ <p>where, in the highest zone (Zone 3), Z was equal to 1, <math>C_p</math> a coefficient with a typical tabulated value of 0.2, and <math>W_p</math> the weight of NSE</p>
UBC 1976 Section 2312g	$F_p = ZI_pC_pW_p,$ <p>where, in the highest seismic zone (Zone 4), Z was equal to 1, <math>C_p</math> a coefficient equal to 3 for most rigid NSEs, and importance factor <math>I_p</math> in the range 1.0-1.5.</p>
UBC 1988 Section 2312g	$F_p = ZI_pC_pW_p,$ <p>where, in the highest zone (Zone 4), Z was equal to 0.4, <math>C_p</math> was 0.75 for most rigid NSEs and 1.5 for most non-rigid NSEs, and <math>I_p</math> in the range 1.00-1.25. <i>(Explicit requirement for dynamic response of non-rigid NSEs was addressed through increased value of <math>C_p</math>, and a factor of 2/3 could be applied to reduce design force for NSEs supported at grade.)</i></p>
UBC 1994 Section 2312g	$F_p = ZI_pC_pW_p,$ <p>where, in the highest zone (Zone 4), Z was equal to 0.4, <math>C_p</math> was 0.75 for most rigid NSEs and 1.5 for most non-rigid NSEs, and <math>I_p</math> in the range 1.0-1.5. <i>(Explicit requirement for dynamic response of non-rigid NSEs was addressed through increased value of <math>C_p</math>, and a factor of 2/3 could be applied to reduce design force for NSEs supported at grade. Importance factor, <math>I_p</math>, raised to 1.5)</i></p>
UBC 1997 Section 1632	$F_p = C_a I_p \frac{a_p}{R_p} \left( 1 + 3 \frac{h_x}{h_r} \right) W_p,$ <p>where, <math>a_p</math> is component amplification factor ranging up to 2.5, but typically equal to 1.0 for rigid NSEs; <math>C_a</math> seismic coefficient related to soil profile and seismic zone, with a value up to 0.88 on soft soil in the near-field and 0.4 for competent soil sites of high seismic regions. <math>F_p</math> is design level force, but the maximum allowable force in connection is only (<math>F_p/1.4</math>) during actual shaking. <math>F_p</math> shall not be less than <math>0.7C_a I_p W_p</math>, and <math>F_p</math> need not be greater than <math>4C_a I_p W_p</math>. (<math>I_p</math> was unchanged from UBC 1994. <math>R_p</math> is component response modification factor ranging from 1.5 to 4.0, with a typical value of 3.0 assigned to most ductile NSEs and their connections; <math>h_x</math> and <math>h_r</math> denote height at which the NSE is present and height of roof from ground level, respectively.)</p>
2006 IBC / ASCE 7-05/ ASCE 7-10 Section 13-3	$F_p = 0.4S_{DS} \frac{a_p}{R_p/I_p} \left( 1 + 2 \frac{z}{h} \right) W_p,$ <p>where, <math>a_p</math> is unchanged from the earlier code; <math>S_{DS}</math> is spectral acceleration at short periods (~0.2s) and varies from 0.02g to 2.00g; <math>R_p</math> is component modification factor that varies from 1 to 12; <math>I_p</math> is component importance factor; 'z' is height of the component and 'h' is height of roof. The factor 0.4 with <math>S_{DS}</math> in the above expression for <math>F_p</math> attempts to estimate effective peak ground acceleration from spectral acceleration value of <math>S_{DS}</math>. The maximum and minimum values of force to be transferred from NSE to SE are <math>F_p = 1.6S_{DS} I_p W_p</math> and <math>F_p = 0.3S_{DS} I_p W_p</math>, respectively</p>



**(b) Design Relative Lateral Displacement for NSEs**

Most design provisions are for estimation of *design lateral forces* for *force-sensitive NSEs*; design provisions for estimation of *design relative lateral deformation* between the two ends of *displacement-sensitive NSEs* came into existence following the 1994 Northridge earthquake in USA. A brief summary is presented in Table 5.4 of the evolution of these provisions available in USA since 1994 for protecting displacement-sensitive NSEs. Details of the latest provisions of 2010 are presented in Table 5.5.

**Table 5.4:** Evolution of *design relative displacement* for *displacement-sensitive NSEs* in US codes

Code & Section	Design Displacement for displacement-sensitive NSEs
ASCE 7 1988 Section 9.10	No Provisions pertaining to displacement-sensitive NSEs were present
ASCE 7 1995 Section 9.3.1.4	<p>Provisions incorporated for the design of displacement sensitive NSEs. Displacement provisions pertaining to</p> <p>(a) <i>NSEs spanning between two locations of a same building</i></p> $D_p = \delta_{xA} - \delta_{yA},$ <p>where <math>\delta_{xA}</math> and <math>\delta_{yA}</math> are deflections of the building at levels X and Y determined accounting for inelastic deformation of the building. <math>D_p</math> refers to design lateral displacement on NSE. No separate provision existed for the design of NSEs governed by deformation prior to this standard. The limiting drift <math>D_p</math> is</p> $D_p = (h_x - h_y) \frac{\Delta_{aA}}{h_{sx}},$ <p>where, <math>h_x</math> is height of building at level X, <math>h_y</math> height at level Y, <math>\Delta_{aA}</math> allowable inter-storey drift, and <math>h_{sx}</math> storey height used for calculation of inter-storey drift.</p> <p>(b) <i>NSEs spanning between two structures</i></p> $D_p =  \delta_{xA}  +  \delta_{yB} ,$ <p>where, <math>\delta_{xA}</math> and <math>\delta_{yB}</math> are deflections of buildings A at level x and of building B at level y, determined accounting for inelastic deformation of the building. Limiting drift <math>D_p</math> is</p> $D_p = \frac{h_x \Delta_{aA}}{h_{sx}} + \frac{h_y \Delta_{aB}}{h_{sy}},$ <p>where, <math>h_x</math> and <math>h_y</math> are heights at level X and level Y, respectively, and <math>\Delta_{aA}</math> and <math>\Delta_{aB}</math> allowable storey drifts for buildings A and B, respectively.</p>
ASCE 7-1998 Section 9.6.1.4	Provisions for displacement design of NSEs remain unchanged
ASCE 7-2002 Section 9.6.1.4, Section 9.6.2.10.2	<p>Provisions for displacement design of NSEs remain unchanged. Additional provision pertaining to drift limits for glass is incorporated.</p> $\Delta_{fallout} = 1.25ID_p,$ <p>where <math>D_p</math> is the inter-storey drift experienced by the building between two levels within which the window is placed. I is the occupancy factor and it varies from 1.0 to 1.5</p>
ASCE 7-2005 Section 13.3	Separate chapter (Chapter 13) for design of NSE. Provisions displacement design of NSEs remains unchanged
ASCE 7- 2010 Section 13.3	<p>Importance factor, <math>I_p</math>, introduced to enhance the survivability of critical displacement sensitive NSEs</p> $D_{pI} = D_p I_e,$ <p>where, <math>D_p</math> is the computed displacement based on the equation pertaining to (a) NSEs spanning between two locations of a same building and (b) NSEs spanning between two structures and <math>I_e</math> the Importance Factor of NSE. For design of glass windows</p> $\Delta_{Fallout} = 1.25I_e D_p,$ <p>where, <math>D_p</math> is the inter-storey drift experienced by the building between two levels within which the window is placed. Occupancy factor (<math>I</math>) associated with the design of façade glass [ASCE 7, 2002; and ASCE, 2005] is replaced with importance factor <math>I_e</math></p>

**Table 5.5:** Design lateral relative displacement for *displacement-sensitive* NSEs as per ASCE 7-10

Code & Year	Design Relative Displacement for NSEs
ASCE 7-10 Section 13-3	$D_{pl} = D_p I_e,$ <p>where, <math>D_p</math> is given by clauses below and <math>I_e</math> the Importance Factor of NSE</p>
ASCE 7-10 Section 13-3  <i>Displacement within a structure</i>	$D_p = \delta_{xA} - \delta_{yA},$ <p>where, <math>\delta_{xA}</math> and <math>\delta_{yA}</math> are deflections of the building at levels X and Y determined accounting for inelastic deformation of the building. <math>D_p</math> refers to design lateral displacement on NSE. No separate provision existed for the design of NSEs governed by deformation prior to this standard. The limiting drift <math>D_p</math> is</p> $D_p = (h_x - h_y) \frac{\Delta_{aA}}{h_{sx}},$ <p>where, <math>h_x</math> is height of building at level X, <math>h_y</math> height at level Y, <math>\Delta_{aA}</math> allowable inter-storey drift, and <math>h_{sx}</math> storey height used for calculation of inter-storey drift.</p>
ASCE 7-10 Section 13-3  <i>Displacement between structures</i>	$D_p =  \delta_{xA}  +  \delta_{yB} ,$ <p>where, <math>\delta_{xA}</math> and <math>\delta_{yB}</math> are deflections of buildings A at level x and of building B at level y, determined accounting for inelastic deformation of the building. Limiting drift <math>D_p</math> is</p> $D_p = \frac{h_x \Delta_{aA}}{h_{sx}} + \frac{h_y \Delta_{aB}}{h_{sy}},$ <p>where, <math>h_x</math> and <math>h_y</math> are heights at level X and level Y, respectively, and <math>\Delta_{aA}</math> and <math>\Delta_{aB}</math> allowable storey drifts for buildings A and B, respectively.</p>
ASCE 7-10 Section 13-3  <i>Window glass</i>	$\Delta_{Fallout} = 1.25 I_e D_p$ <p>where, <math>D_p</math> is the inter-storey drift experienced by the building between two levels within which the window is placed.</p>

There are three possible displacement effects on NSEs. These include:

- Relative deformation between the two ends of the NSE spanning between a building and outside ground;
- Relative deformation between the two ends of the NSE spanning between two floors of the same building; and
- Relative deformation between the two ends of the NSE spanning over two buildings or two parts of the same building that move relative to each other.

There are two methods of estimating these design relative deformations, namely *Nonlinear Analysis Method* and *Approximate Method*. The *first* method requires the designer to undertake nonlinear structural analysis of the building. There is subjectivity in the method of modeling the building structure and its nonlinear (inelastic) structural analysis, including the choice of the ground motion considered for estimating the inelastic deformation in the building. And, the *second* method uses an indirect method for estimating the inelastic deformations of the building, through the elastic deformations under design lateral forces on the building and the response reduction factor  $R$  of the building. This approach is simpler, and is useful when designers do not have adequate background in nonlinear seismic analysis of buildings. This method is used in the seismic design guidelines for displacement design of *displacement-sensitive* NSEs in India, described in Section 5.1.2.

### 5.1.2 IITK-GSDMA Guidelines for Force Design

The current Indian Seismic Code IS:1893 (Part1)-2007 [IS:1893, 2007] does not have any provisions explicitly related to NSEs. It has a couple of provisions for the design of connections of small items projecting out of buildings in the vertical and horizontal directions; these projections are termed as *appendages to buildings*. These projections are items that are required for the functionality of the building, e.g., towers, tanks, parapets and smoke stacks projecting in the vertical direction, and cornices and balconies projecting in the horizontal directions, and not stated to be for NSEs. Clause 7.12.2 requires connection between a vertical projection and building to be designed for 5 times the horizontal design acceleration coefficient  $A_h$  for which the associated building is designed in which the projection is present, multiplied by weight  $W$  of the projection. Similarly, connection between horizontal projection and the building is required to be designed for 5 times vertical design acceleration coefficient  $A_v$  multiplied by weight  $W$  of the projection. For instance, as per IS:1893 (Part 1)-2007, important RC buildings in high seismic regions are required to be designed for a maximum *design acceleration coefficient* of  $0.18g$ . Therefore, *vertical* and *horizontal* projections in these buildings and their connections with buildings are required to be designed for a maximum of about  $0.90g$  and about  $0.60g$ , respectively.

A summary of seismic design provisions is listed in Table 5.6. The salient design provisions common to all the codes are (1) floor response spectrum method of analysis was employed to assess the force demand imposed on NSEs, and (2) the importance factor used for the design of critical NSEs varied between 1.0 and 2.0. A review was undertaken of the seismic design provisions available elsewhere in the world [Mondal and Jain, 2005], with the intent of proposing basic provisions for seismic design of NSEs for the Indian Seismic Code. Consequently, a set of *basic guidelines* for NSEs was proposed [IITK-GSDMA, 2005] for possible consideration by the Indian Seismic Code; hereinafter, these draft provisions will be referred to as IITK-GSDMA guidelines. In the sub-sections below, these provisions are presented as *representative provisions* for understanding design provisions for earthquake protection of NSEs. A comparison is presented in Chapter 5 of the design forces for NSEs as required by the Indian and American practices. This will help in understanding simplifications adopted by current code provisions, know challenges present in seismic design of NSEs, and clarify some uncertainties associated in protecting NSEs.

IITK-GSDMA guidelines give expressions to estimate the design lateral force for connectors between the NSEs and the SEs. This is in line with code provisions in majority of international codes [e.g., IBC, 2009; ASCE/SEI 7, 2010, EC8, 1998]. In Clause 7.13.1.2, IITK-GSDMA guidelines clarify that the clauses therein are applicable only when the NSE does not directly modify the strength or stiffness of the SEs of the building, or significantly add to the mass of the building. In general, an NSE is said to be having significant mass, if its mass exceeds 20% of that of floor on which it is anchored, or 10% of total mass of building in which it is present. In essence, IITK-GSDMA guidelines use *Floor Response Spectra* analysis method for determining the design force levels. Hence, all advantages and disadvantages pertaining to floor response spectra method are relevant to these provisions.

For those NSEs that alter the stiffness or mass of the building, the NSE in discussion should be treated as a SE; all provisions relevant to SEs shall be applicable to this *so called* NSE. This element should be included in the structural analysis of the building; the forces required to connect this element to the other SEs be determined accordingly. For example, unreinforced masonry (URM) infill walls should be considered as structural elements for response under lateral seismic shaking. When these URM infills adjoin structural columns, they can foul with the movement of the columns, cause short-column effect, and seriously alter the building response.

**Table 5.6:** Comparison of some international codes of practice

Code	Natural Period of Building ( $T$ )	Natural Period of NSE ( $T_p$ )	Site Soil Condition	Equation for Amplification along Height	Flexibility of NSEs	Limiting Mass and frequency ratio
IITK-GSDMA Guidelines	Not Considered	Not Considered	Not Considered	$\left(1 + \frac{x}{h}\right)$	$a_p = 1.0$ for rigid $a_p = 2.5$ for flexible	10% of weight of building  20% of weight of floor  No Limitation on frequency limits
Eurocode 8 1998	Considered	Considered	Considered	$\frac{3\left(1 + \frac{x}{h}\right)}{1 + \left(1 - \frac{T_p}{T}\right)} - 0.5$	Indirectly through Natural Period of NSE $T_p$	Not specified
UBC 1997	Not Considered	Not Considered	Considered	$\left(1 + \frac{3x}{h}\right)$	$a_p = 1.0$ for rigid $a_p = 2.5$ for flexible	25% of weight of building  No Limitation on frequency limits
IBC2009/ASCE7-10	Not Considered	Not Considered	Considered	$\left(1 + \frac{2x}{h}\right)$	$a_p = 1.0$ for rigid $a_p = 2.5$ for flexible	25% of weight of building  No Limitation on frequency limits
NZ 1170.5: 2004	Not Considered	Considered	Considered	For $h < 12m$ , $\left(1 + \frac{2x}{h}\right)$ For $h > 12m$ $\left(1 + \frac{10x}{h}\right)$ if $x < 0.2h$ , and 3.0 if $x > 0.2h$	$a_p = 2.0$ for $T_p < 0.75s$ $a_p = 0.5$ for $T_p \geq 1.5s$ $a_p = 2(1.75 - T_p)$ for $0.75 < T_p < 1.5$	20% of weight of building  Lowest translational Period is lesser than 0.2s
NBCC 1995	Not Considered	Not Considered	Considered	$\left(1 + \frac{x}{h}\right)$	$a_p = 1.0$ for rigid $a_p = 2.5$ for flexible	10% of weight of floor

### (a) Design Lateral Force for SEs

When buildings shake during earthquakes, the level of accelerations in the buildings can be more than that at the ground (PGA: *Peak Ground Acceleration*), depending on the natural period  $T$  of the building. This is reflected in the design acceleration spectrum value  $S_a/g$  given by (Figure 5.1):

$$\frac{S_a}{g} = \begin{cases} \begin{cases} 2.5 & 0.00 < T < 0.40 \\ \frac{1.00}{T} & 0.40 < T < 4.00 \end{cases} & \text{for Soil Type I : rocky or hard soil sites} \\ \begin{cases} 2.5 & 0.00 < T < 0.55 \\ \frac{1.36}{T} & 0.55 < T < 4.00 \end{cases} & \text{for Soil Type II : medium soil sites} \\ \begin{cases} 2.5 & 0.00 < T < 0.67 \\ \frac{1.67}{T} & 0.67 < T < 4.00 \end{cases} & \text{for Soil Type III : soft soil sites} \end{cases} \quad (5.1)$$

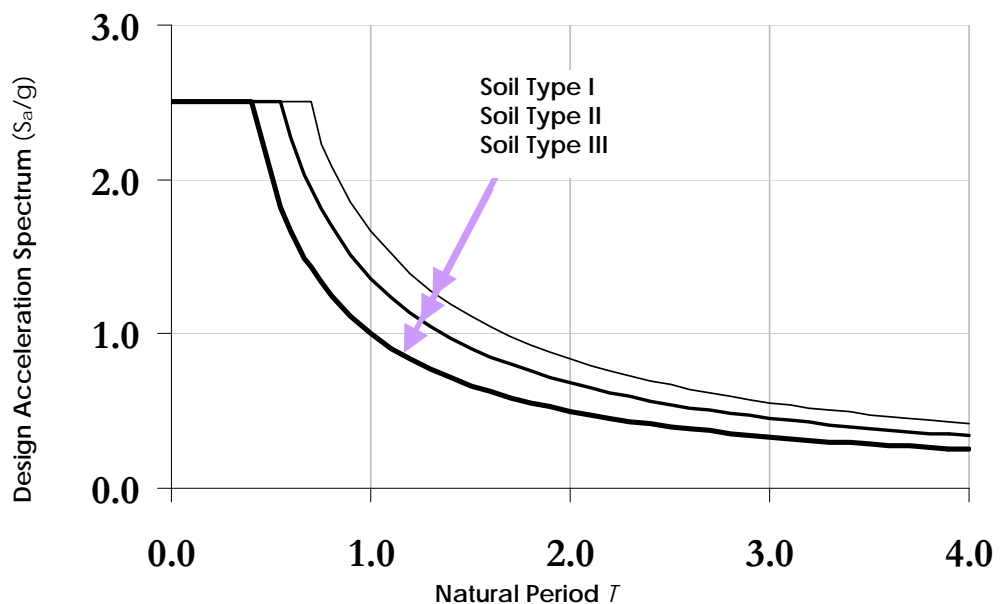
The design lateral force for structural elements (SEs) is given by

$$V_B = \frac{ZI}{2R} \left( \frac{S_a}{g} \right) W, \quad (5.2)$$

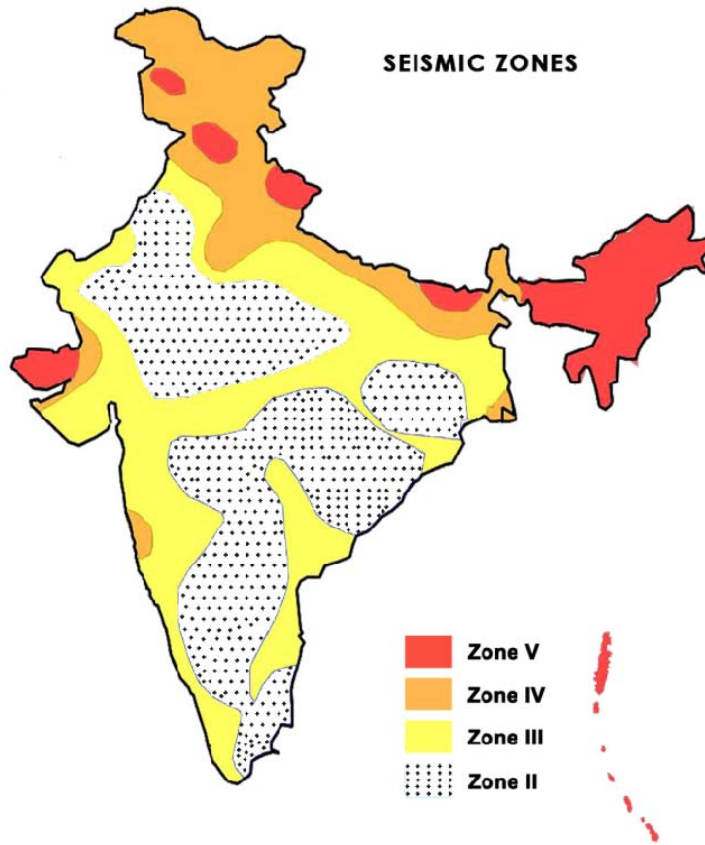
where,  $Z$  is the Seismic Zone Factor (Table 5.7) at different locations in India as per Figure 5.2,  $I$  the Importance Factor of different building types,  $R$  the Response Reduction Factor of buildings with different structural systems and materials, and  $W$  the Seismic Weight of the Building. The factors  $Z$ ,  $I$ ,  $R$  and  $W$  are defined by IS:1893 (Part 1) - 2007. Eq.(5.2) suggests that the acceleration experienced by the building can be up to 2.5 times larger than the peak ground acceleration (PGA). This information is important in the design of NSEs also.

**Table 5.7:** Seismic Zone Factor  $Z$  at different locations in India as per IS:1893 (Part 1) - 2007

Seismic Zone	V	IV	III	II
$Z$	0.36	0.24	0.16	0.10
Note: The zone in which a building is located can be identified from the Seismic Zone Map of India given in IS:1893-2007 (sketched in Figure 5.2).				



**Figure 5.1:** Design Acceleration Spectrum for Design of SEs: As per IS:1893 (Part 1)-2007, design acceleration value depends on the natural period  $T$  of the building and soil type



**Figure 5.2:** Sketch of Seismic Zone Map of India: sketch based on the actual seismic zone of India map given in IS:1893 (Part 1)-2007

**(b) Design Lateral Force for NSEs**

Clause 7.13.3 of IITK-GSDMA guidelines gives the design lateral force  $F_p$  for design of NSEs as:

$$F_p = \frac{Z}{2} \left( 1 + \frac{x}{h} \right) \frac{a_p}{R_p} I_p W_p, \tag{5.3}$$

where,  $Z$  is the Seismic Zone Factor (Table 5.7),  $I_p$  the Importance Factor of the NSE (Table 5.8),  $R_p$  the Component Response Modification Factor (Table 5.9),  $a_p$  the Component Amplification Factor (Table 5.9),  $W_p$  the Weight of the NSE,  $x$  the height of point of attachment of the NSE above top of the foundation of the building, and  $h$  the overall height of the building.

The acceleration at the point of attachment of the NSE to the SE depends on peak ground acceleration, dynamic response of the building, and location of the element along the height of the building. In Eq.(5.3), the acceleration at the point of attachment is simplified and is considered to be linearly varying from the acceleration at the ground (taken as  $0.5Z$ ) to the acceleration at the roof (taken to be twice as much, *i.e.*,  $Z$ ).

**Table 5.8:** Importance Factors  $I_p$  of NSEs as per IITK-GSDMA guidelines

NSE	$I_p$
Component containing hazardous contents	1.5
Life safety component required to function after an earthquake ( <i>e.g.</i> , fire protection sprinklers system)	1.5
Storage racks in structures open to the public	1.5
All other components	1.0

**Table 5.9:** Coefficients  $a_p$  and  $R_p$  of Architectural, Mechanical and Electrical NSEs as per IITK-GSDMA guidelines

S.No.	Item	$a_p$	$R_p$
1	<b>Architectural Component or Element</b>		
	<i>Interior Non-structural Walls and Partitions</i>		
	Plain (unreinforced) masonry walls	1.0	1.5
	All other walls and partitions	1.0	2.5
	<i>Cantilever Elements (Unbraced or braced to structural frame below its center of mass)</i>		
	Parapets and cantilever interior non-structural walls	2.5	2.5
	Chimneys and stacks where laterally supported by structures.	2.5	2.5
	<i>Cantilever elements (Braced to structural frame above its center of mass)</i>		
	Parapets	1.0	2.5
	Chimneys and stacks	1.0	2.5
	Exterior Non-structural Walls	1.0	2.5
	<i>Exterior Non-structural Wall Elements and Connections</i>		
	Wall Element	1.0	2.5
	Body of wall panel connection	1.0	2.5
	Fasteners of the connecting system	1.25	1.0
	<i>Veneer</i>		
	High deformability elements and attachments	1.0	2.5
	Low deformability and attachments	1.0	1.5
	<i>Penthouses (except when framed by and extension of the building frame)</i>	2.5	3.5
	<i>Ceilings</i>		
	All	1.0	2.5
	<i>Cabinets</i>		
	Storage cabinets and laboratory equipment	1.0	2.5
	<i>Access floors</i>		
	Special access floors	1.0	2.5
	All other	1.0	1.5
	<i>Appendages and Ornamentations</i>	2.5	2.5
	<i>Signs and Billboards</i>	2.5	2.5
	<i>Other Rigid Components</i>		
	High deformability elements and attachments	1.0	3.5
	Limited deformability elements and attachments	1.0	2.5
	Low deformability elements and attachments	1.0	1.5
	<i>Other flexible Components</i>		
	High deformability elements and attachments	2.5	3.5
	Limited deformability elements and attachments	2.5	2.5
	Low deformability elements and attachments	2.5	1.5
2	<b>Mechanical and Electrical Component/Element</b>		
	<i>General Mechanical</i>		
	Boilers and Furnaces	1.0	2.5
	Pressure vessels on skirts and free-standing	2.5	2.5
	Stacks	2.5	2.5
	Cantilevered chimneys	2.5	2.5
	Others	1.0	2.5
	<i>Manufacturing and Process Machinery</i>		
	General	1.0	2.5
	Conveyors (non-personnel)	2.5	2.5
	<i>Piping Systems</i>		
	High deformability elements and attachments	1.0	2.5
	Limited deformability elements and attachments	1.0	2.5
	Low deformability elements and attachments	1.0	1.5
	<i>HVAC System Equipment</i>		
	Vibration isolated	2.5	2.5
	Non-vibration isolated	1.0	2.5
	Mounted in-line with ductwork	1.0	2.5
	Other	1.0	2.5
	<i>Elevator Components</i>	1.0	2.5
	<i>Escalator Components</i>	1.0	2.5
	<i>Trussed Towers (free-standing or guyed)</i>	2.5	2.5
	<i>General Electrical</i>		
	Distributed systems (bus ducts, conduit, cable tray)	2.5	5.0
	Equipment	1.0	1.5
	<i>Lighting Fixtures</i>	1.0	1.5

The component response modification factor  $R_p$  reflects the ductility, redundancy and energy dissipation capacity of the NSE and its attachment to the SE. Little research is done on estimation of these factors. The component amplification factor  $a_p$  reflects the dynamic amplification of the NSE relative to the fundamental natural period  $T$  of building in which the NSE is present. Experimental research studies using shake tables are required to evaluate fundamental natural period of the NSE, which may not be feasible for all the NSEs employed in architectural and civil engineering practice. Hence, as a simplification of the design process, the connection of the NSE to the SE is designed without needing the value of  $T$  of the building or that of the NSE. Values of  $a_p$  and  $R_p$  given in IITK-GSDMA guidelines (Table 5.9) are taken from the NEHRP provisions [FEMA 369, 2001]; these empirically specified values are based on “collective wisdom and experience of the responsible committee”. The NSEs with flexible body are assigned  $a_p$  of 2.5, and that with rigid body, 1.0. Values of  $R_p$  are taken as 1.5, 2.5 and 3.5 for low, limited and high deformable NSEs, respectively. Values of  $a_p$  lower than those specified in Table 5.9 are permitted provided detailed dynamic analyses are performed to justify the same; in any case,  $a_p$  shall not be less than 1.0, that is assigned for equipment that are generally rigid and are rigidly attached.  $a_p$  is assigned a value of 2.5 for flexible components and flexibly attached components.

The expression given in Eq.(5.3) for the design lateral force  $F_p$  is a simplified one for assuring safety of the NSE. In most NSEs, the users (Architects and Engineers) would be required to question manufacturers of the NSEs of the safety of the NSE under this force  $F_p$  applied in the *random sense* that earthquakes impose these forces on the NSE, and not in a static sense. Manufacturers, who are sensitive to the safety of NSEs during earthquakes, tend to conduct full scale shake table tests at their end, before releasing the NSE into the market for sale.

The force values  $F_p$  arrived at using Eq.(5.3) provide a lower limit of seismic design force for the design of NSEs; one can use higher level of forces for design, if detailed analysis performed shows the same. For NSEs that are important and critical, detailed *nonlinear time history analyses* should be conducted of the buildings, wherein the NSE is present, under different ground motions, to determine the actual force experienced by the NSE. Alternately, seismic structural analysis can be performed using the design acceleration response spectrum at the base of the building and the design floor acceleration response spectrum (called the *floor response spectrum*) determined at the level of the connection between the NSE and SE.

The design lateral force  $F_p$  given by Eq.(5.3) is valid for NSEs that are attached to horizontal surfaces of SEs as well as to vertical surfaces of SEs. For NSEs that are projecting out of horizontal surfaces of SEs,  $F_p$  is the horizontal force tangential to horizontal surfaces of SEs to which the NSEs are attached. And, for NSEs that are projecting out of vertical surfaces,  $F_p$  is the vertical force tangential to vertical surfaces of SEs to which the NSEs are attached. Even though the vertical and horizontal earthquake vibrations of the ground and of the building (at different levels) are different, for the purposes of design of normal SEs, no distinction is being made in the estimation of the design lateral force  $F_p$  for connecting NSEs to vertical or horizontal surfaces of SEs. This is attributed to numerous other approximations involved in the derivation of the expression for  $F_p$ .

When NSEs are mounted on vibration isolation systems, the IITK-GSDMA guidelines require connections between the NSEs and the SEs to be designed for *twice* the value of the design lateral force  $F_p$ . The mass of the NSE along with the flexible mounts employed in the isolation system can be visualized to have a fundamental natural mode of vibration and an associated natural period. The isolated NSE will experience amplification of its vibrations when this fundamental natural mode of its vibration experiences *resonance-like* condition with one or more natural modes of vibration of the building on which it is mounted. Hence, the NSE placed on a vibration isolator can experience higher seismic accelerations, than if it is rigidly mounted on the SE without the isolator. The IITK-GSDMA guidelines recognise this effect.



### 5.1.3 IITK-GSDMA Guidelines for Displacement Design

Over the last two decades, countries faced with high earthquake hazard have recognized the importance of seismic safety of NSEs along with that of the buildings and their SEs. *Displacement-sensitive* NSEs and their connections are designed to sustain the relative displacements imposed at the ends during earthquake shaking.

#### (a) Design Relative Lateral Displacement for SEs

When buildings shake during earthquakes, they move laterally by different amounts at different levels. Under the design lateral force  $V_B$ , buildings are required by the Indian Seismic Code IS:1893 (Part 1) -2007 to not deform laterally by more than 0.4% of the height. This is applicable to the overall lateral displacement of the building as well as to the inter-storey displacement. But, these displacement values under the design lateral forces are only a fraction of the actual displacements that normal buildings are likely to deform by during strong earthquake shaking. This is attributed to the fact that normal buildings are not designed to remain elastic during earthquake shaking, and hence, designed only for a fraction of the lateral force that the building is likely to experience, if it were to remain elastic. The main reason for this is that earthquake shaking imposes *displacement-loading* on buildings, and not *force-loading*.

#### (b) Design Relative Lateral Displacement for NSEs

The seismic relative displacement  $D_p$  for which NSEs must be designed to accommodate, shall be determined as per Clauses 7.13.4.1, 7.13.4.2 and 7.13.4.3 of the IITK-GSDMA guidelines. These values are helpful to architects and engineers to select and design NSEs that are connected to buildings at multiple levels of the same building or of adjacent buildings. These expressions given in the following provide a rational basis for assessing the flexibility or clearances required by NSEs, and their connections, to accommodate the expected building movements during earthquake shaking.

Clause 7.13.4.1 of IITK-GSDMA guidelines provisions provide an estimate of the seismic relative displacement  $D_p$  between two levels on the *same building*, one at height  $h_x$  and other at height  $h_y$  from the base of the building across which the NSE spans, as:

$$D_p = \delta_{xA} - \delta_{yA}, \quad (5.4)$$

but the value of  $D_p$  should not be greater than

$$\Delta_{\max} = R(h_x - h_y) \frac{\Delta_{aA}}{h_{sx}}, \quad (5.5)$$

where,  $\delta_{xA}$  and  $\delta_{yB}$  are the seismic deflections at building levels  $x$  and  $y$  of the building under the application of the design seismic lateral force determined by elastic analysis of the building, and multiplied by Response Reduction factor  $R$  of the building (Table 5.10),  $h_x$  and  $h_y$  the heights of building at levels  $x$  and  $y$  at which the top and bottom ends of the NSE are attached,  $\Delta_{aA}$  the allowable storey drift of building A at level  $x$  calculated as per Clause 7.12.1 of the IITK-GSDMA guidelines, and  $h_{sx}$  height of storey below level  $x$  of the building A.

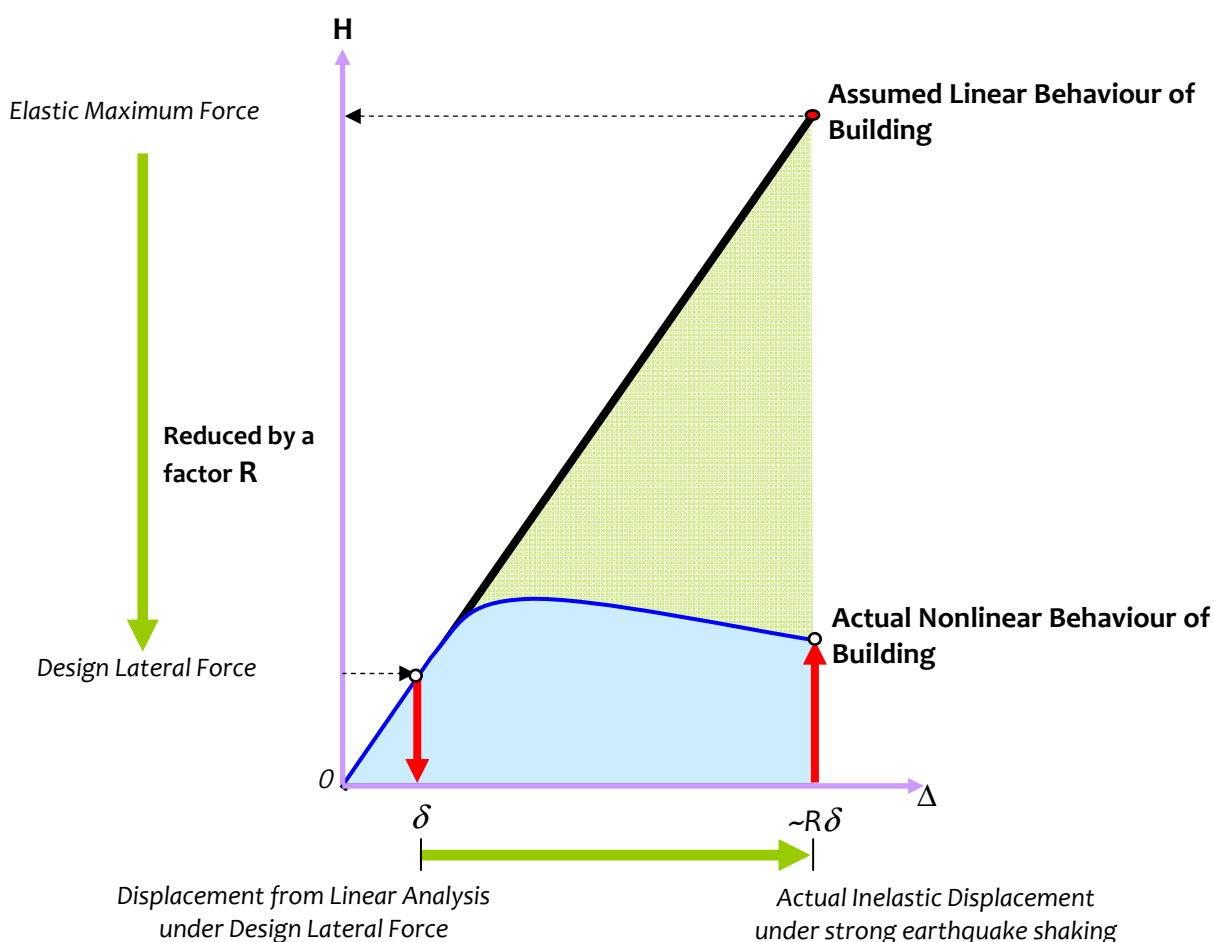
In the calculation of  $D_p$ , the multiplication with  $R$  is a critical step. Figure 5.3 clarifies this. If  $\delta$  is the displacement from Linear Analysis at point  $x$  in building A subjected to *Design Lateral Force*, then the actual displacement  $\delta_{xA}$  of the building that undergoes nonlinear actions is estimated by an excellent approximation that was proposed [Newmark and Hall, 1973], as

$$\delta_{xA} \approx R\delta. \quad (5.6)$$

The safety of NSEs governed by displacement actions is controlled by this simple procedure. Eq.(5.4) requires an estimate of the actual displacements of the SEs using displacements determined by elastic analysis based on design lateral forces on the building. Hence, Eq.(5.5) provides a way of estimating the actual maximum relative displacement that is expected between the ends of the NSE considering the from displacements obtained from results of elastic analysis of the building under design lateral forces Response Modification Factor  $R$  of the building.

**Table 5.10:** Response Reduction Factor  $R$  for Building Systems from Table 7 of IITK-GSDMA guidelines

S.No.	Lateral Load Resisting System	$R$
<b>Building Frame Systems</b>		
i	Ordinary RC moment-resisting frame (OMRF)	3.0
ii	Intermediate RC moment-resisting frame (IMRF)	4.0
iii	Special RC moment-resisting frame (SMRF)	5.0
iv	Steel frame with (a) Concentric Brace Frame (b) Eccentric Braces	4.0 5.0
v	Steel moment-resisting frame designed as per SP:6(6)	5.0
<b>Buildings with Shear Walls</b>		
vi	Load bearing masonry wall buildings (a) Unreinforced masonry without special seismic strengthening (b) Unreinforced masonry strengthened with horizontal RC bands and vertical bars at corners of rooms and jambs of openings (c) Ordinary reinforced masonry shear wall (d) Special reinforced masonry shear wall	1.5 2.25 3.0 4.0
vii	Ordinary reinforced concrete shear walls	3.0
viii	Ductile shear walls	4.0
<b>Buildings with Dual Systems</b>		
ix	Ordinary shear wall with OMRF	3.0
x	Ordinary shear wall with SMRF	4.0
xi	Ductile shear wall with OMRF	4.5
xii	Ductile shear wall with SMRF	5.0



**Figure 5.3:** Relating Design Displacements with Actual Displacements of a Building: Elastic displacements from linear analysis need to be amplified by  $R$  to estimate inelastic displacements that are experienced by buildings

Clause 7.13.4.2 of IITK-GSDMA guidelines gives an estimate of the seismic relative displacement  $D_p$  between two points on two *adjoining buildings*, one on the first building (Building A) at height  $h_x$  from its base and other on the second building (Building B) at height  $h_y$  from its base, across which the NSE spans, as:

$$D_p = |\delta_{xA}| + |\delta_{yB}|, \quad (5.7)$$

but the value of  $D_p$  should not be greater than

$$\Delta_{\max} = R \left( h_x \frac{\Delta_{aA}}{h_{sx}} + h_y \frac{\Delta_{aB}}{h_{sy}} \right), \quad (5.8)$$

where,  $R$  is the Response Reduction factor of the buildings (Table 5.10),  $h_x$  and  $h_y$  the heights of buildings at levels  $x$  and  $y$  at which the top and bottom ends of the NSE are attached,  $\Delta_{aA}$  and  $\Delta_{aB}$  the allowable storey drifts of buildings A and B calculated as per Clause 7.12.1 of the IITK-GSDMA guidelines, and  $h_{sx}$  and  $h_{sy}$  heights of storeys below levels  $x$  and  $y$  of the buildings. Clause 7.13.4.3 of IITK-GSDMA guidelines requires that the seismic relative displacements mentioned above be combined with displacements caused by other loads, like thermal and static loads.

## 5.2 EARTHQUAKE PERFORMANCE OF CODE-DESIGNED CONNECTIONS OF NSES

Literature on code-designed connections of NSEs is limited. Limited data available suggests that while performance of some NSEs was satisfactory during some past earthquakes, many NSEs were damaged and led to economic losses. This motivated periodic revision of codes as illustrated using Tables 5.3 and 5.4. A major change in design provisions in each revision was upgrade of design force level for *force-sensitive* NSEs, and it was observed that not all NSEs designed were damaged in the 1994 Northridge earthquake [Gates and McGavin, 1998]. Further, it was observed that the intensity of shaking experienced by NSEs in certain buildings (based on data obtained from twenty instrumented buildings during 1994 Northridge earthquake) correlate well with code provisions [Naiem and Lobo, 1998]. Further, it was observed that, in general, force-sensitive NSEs (*e.g.*, mechanical and electrical equipments that were rigidly bolted and anchored to floors) performed acceptably when anchorages were designed for code-specified force limits. Otherwise, numerous instances of overturning of liquid storage tanks were observed due to pulling out of anchor bolts or collapse of support legs.

Two major reasons attributed to failure of anchor bolts are faulty design of anchor bolts, and faulty installation of anchor bolts [Loyed, 2003]. An important result of faulty connection design of force-sensitive NSEs was that inadequate or damaged connection increases flexibility of NSEs. This results in higher component amplification than that envisaged in design (maximum of 2.5) when the natural period of flexible NSE lies in the vicinity of fundamental periods associated with ground motion and/or building in which it is housed. The component amplification is further increased as the damping associated with NSEs is usually small compared to that in SEs. The amplification leads to further damage of the connections, and eventually leads to overturning, collapse, etc., of the NSEs. Analytical studies suggest component amplification as high as 9.0 [Singh *et al*, 2006].

Displacement-sensitive NSEs too performed to varying degree during past earthquakes. Failure of pipes was observed due to differential movement at ends [Loyed, 2003]. The relative deformation at ends was amplified due to inelastic actions of the SEs.

### 5.3 LIMITATIONS IN CURRENT DESIGN PRACTICE

Earthquake performance of buildings depends largely on performance of their SEs and NSEs. It is important to control earthquake performance of NSEs to mitigate loss of life, reduce cost of repair, and enhance the chance of effective/proper functioning of critical and important structures. Controlling performances of NSEs involves proper understanding of their behaviour under seismic action. To ensure that NSEs survive even after earthquakes, the demand imposed on NSEs and responses of NSEs to the imposed demands need to be ascertained reasonably accurately. Based on their behaviour, NSEs were classified into two types, namely *force-sensitive NSEs* and *displacement-sensitive NSEs*. The former NSEs are secured by estimating overturning inertia forces imparted due to shaking of support points of NSE on SEs, and designing their connections to SEs to anchor the NSEs properly to SEs. While doing so, the demand imposed by NSEs on SEs need to be accounted for in the design of SEs. And, the latter NSEs are secured by accommodating the relative deformation generated between their support points on SEs.

The design and subsequent performance of NSEs depends on the importance/criticality of the building in which they are placed/used. In critical structures, NSEs are expected to be designed such that they are fully operational after the earthquake. The functionality of *force-sensitive NSEs* depends on effective and safe transfer of inertia forces to SEs. Hence, it is essential to design the connections between NSEs and SEs. Connections between NSEs and SEs are to be designed for the minimum lateral force and /or at least the minimum lateral displacement as defined by country specific seismic codes. Further, the displacement induced in SEs, when the building is subjected to minimum lateral force, should be within the limits, such that there is no interference between two adjacent NSEs or between NSEs and SEs. Demand on *force-sensitive NSEs* and *deformation-sensitive NSEs varies significantly* with increase in inelasticity associated with SEs. A review of the current code provisions for the design of NSEs reveals considerable uncertainties pertaining to each parameter used in design. Hence, designers should do everything necessary for reducing uncertainties associated with the computation of force and displacement demands on NSEs.

### 5.4 UNCERTAINTIES IN UNDERSTANDING EARTHQUAKE BEHAVIOUR OF NSEs

This section explains the uncertainties in both the *design forces* and *design relative displacements* to be considered in the design and detailing of NSEs and their connections to SEs. To appreciate these, step-wise improvements made are presented in the seismic design provisions for NSEs in the codes of USA, as an example (Table 5.3 and Table 5.4). The evolution has been gradual of seismic design provisions for acceleration sensitive NSEs. The early provisions were introduced in the Uniform Building Code (UBC) of 1937 [UBC, 1937] and improved in the subsequent revisions in 1961, 1976, 1988, 1994 and 1997 [UBC, 1961, 1976, 1988, 1994 and 1997]. Later, the International Building Code (IBC) became the reference document for seismic design in USA. Provisions were introduced in the 2000 version of IBC, which were improved versions of those in UBC 1997; the same is reflected in the ASCE 7-10 document of the American Society of Civil Engineers, USA [ASCE 7-10, 2010]. Uncertainties associated with the provisions related to both force-sensitive and displacement-sensitive NSEs are discussed below.

#### 5.4.1 Design Lateral Force for NSEs

In the expression for design lateral force  $F_p$  on a *force-sensitive NSE* (Eq.(5.3)), the uncertainties can be in any of the parameters, namely Design Peak Ground Acceleration  $Z$ , soil type and stratum at the site of building, distribution of floor acceleration along height of the building reflected by the term  $(1 + \alpha z/H)$ , Component Amplification Factor  $a_p$ , Component Response Reduction Factor  $R_p$ , Importance Factor  $I_p$ , and weight of the component  $W_p$ . Uncertainties associated with each of these factors are presented below.

Comparison of the minimum lateral force (as percentage of the weight of NSE) indicates that NSEs are required to be designed for larger fraction of the weight of NSE as compared to the SEs, which implies that even under minor shaking, the force imparted on NSEs can be significantly high.

Further, the design lateral forces  $F_p$  for NSEs given by IBC 2009 / ASCE 7-10 are largely controlled by their  $a_p/R_p$  values. For soft soil conditions,  $F_p$  for NSEs with lowest value of  $a_p/R_p$  ( $=0.21$ ) is about  $0.68W_p$  in high seismic regions and  $0.15W_p$  in low seismic regions. And, for NSEs with highest value of  $a_p/R_p$  ( $=1.67$ ),  $F_p$  is about  $4.30W_p$  in high seismic regions and  $1.20W_p$  in low seismic regions. In comparison, the values from Indian provisions [IITK-GSDMA, 2005] are: for NSEs with lowest value of  $a_p/R_p$  ( $=0.29$ ) is about  $0.31W_p$  in low seismic regions, and, for NSEs with highest value of  $a_p/R_p$  ( $=1.67$ ) about  $1.80W_p$  in high seismic regions. The sharp difference is primarily due to the low estimate of seismic hazard (though the design peak ground acceleration at the base of the building). Code writers of specific countries argue that the values of  $Z$  adopted in each country reflect the economic potential of that country to invest in earthquake safety. But, it is unclear that such arguments auger well for earthquake safety of NSEs, which experience much higher accelerations than considered in design. Thus, until better estimate of seismic hazard (through the design peak ground acceleration at the base of the building) is obtained, the design force for NSEs in India, in *Critical & Lifeline Buildings* in particular, can be made comparable to international standards by assigning higher values of Importance Factor  $I_p$  to these NSEs. The proposed Importance Factors  $I_p$  for NSEs are given in Table 5.11.

### (a) Design Peak Ground Acceleration $Z$

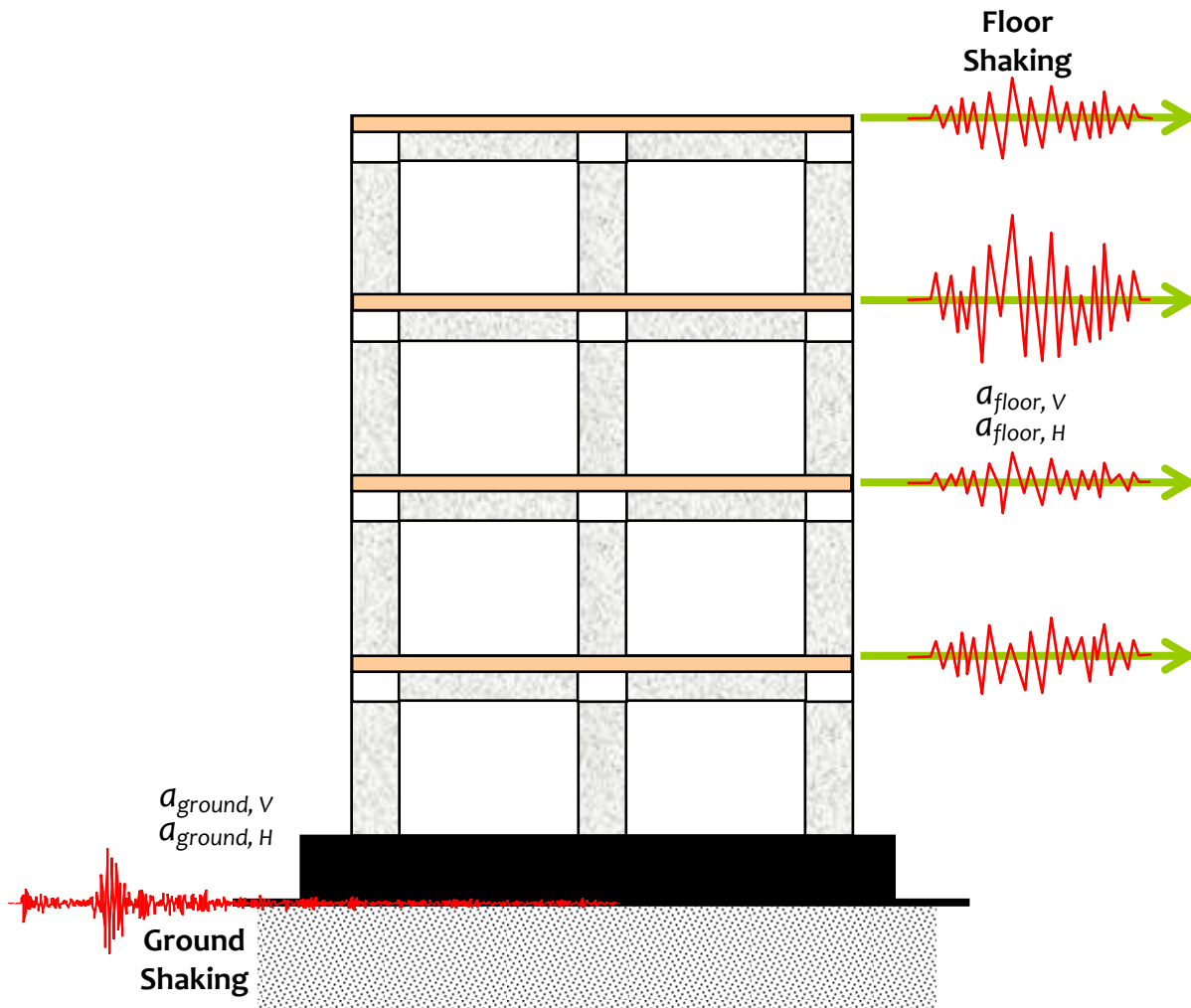
Design peak ground acceleration is estimated by deterministic and probabilistic seismic hazard assessment. It is possible that the value of  $Z$  for which the building is designed, may be exceeded during an actual earthquake. In many countries, like India, the value of  $Z$  is deliberately kept low. In such instances,  $F_p$  on an NSE using code specified expression will be lower than the demand expected during a strong earthquake. The uncertainties associated with estimation of  $Z$  include many factors. Firstly, the distance of the building from the neighbouring fault system governs the type of ground motion experienced by the building - *near field type* or *far field type*. The amplitude and frequency content of these two types of ground motions are distinctly different. Secondly, the *length of fault rupture*, *skew angle of the fault to the building* and *directivity of rupture* influence the ground motion at the building site. Thirdly, if 3-directional ground motion is considered as against 1-directional horizontal ground motion, the shaking at the base of the building may be completely different [Pekan *et al*, 2003]. In the Indian provisions, the maximum value of design peak ground acceleration  $Z$  is  $0.36g$ , and in the American code  $\sim 0.86g$ .

### (b) Soil Type & Stratum at the Building Site

Expressions for design of connection of force-sensitive NSEs to the SEs are available in codes of practice [*e.g.*, IBC, 2009; ASCE 7, 2010] for five types of soil conditions on which the building is resting. But, the Indian provisions do not reflect this dependence on soil conditions at the building site in which the NSE is present, particularly, possible increase in dynamic amplification of acceleration at the base of buildings rested on soft soils, and hence, at floor levels and at base of NSEs attached to such floors. Understandably, soil effects make a difference in the design of buildings and therefore should affect the design forces for NSEs and their connections to the SEs.

### (c) Floor Acceleration and Displacements along Building Height

Distribution of floor acceleration along the height of buildings (Figure 5.4) depends on all factors that influence the behaviour of the building. These include: (a) lateral load resisting system of the building, (b) distribution of mass and lateral stiffness along the height of the building, (c) extent of mass, stiffness and strength irregularity in the building along its height and plan, (d) participation of higher modes, (e) level of inelasticity in the building, and (e) type, location, extent and severity of damage to structural systems [Kehoe and Freeman, 1998; Villaverde, 1998; Rodriguez *et al*, 2002; Kingston, 2004; Chaudhri and Hutctchinson, 2004; Miranda and Taghavi, 2005; Taghavi and Miranda, 2005; Singh *et al*, 2006; Medina *et al*, 2006; Akhlaghi and Mogadam, 2008; Dowell *et al*, 2008; Chaudhri and Villaverde, 2008; Kumari and Gupta, 2008; Chaudhri and Hutchinson, 2011]. Thus, it requires careful modelling of the building structural system along with all its possible modes of damage under the representative ground motions, to better estimate the distribution of floor accelerations.



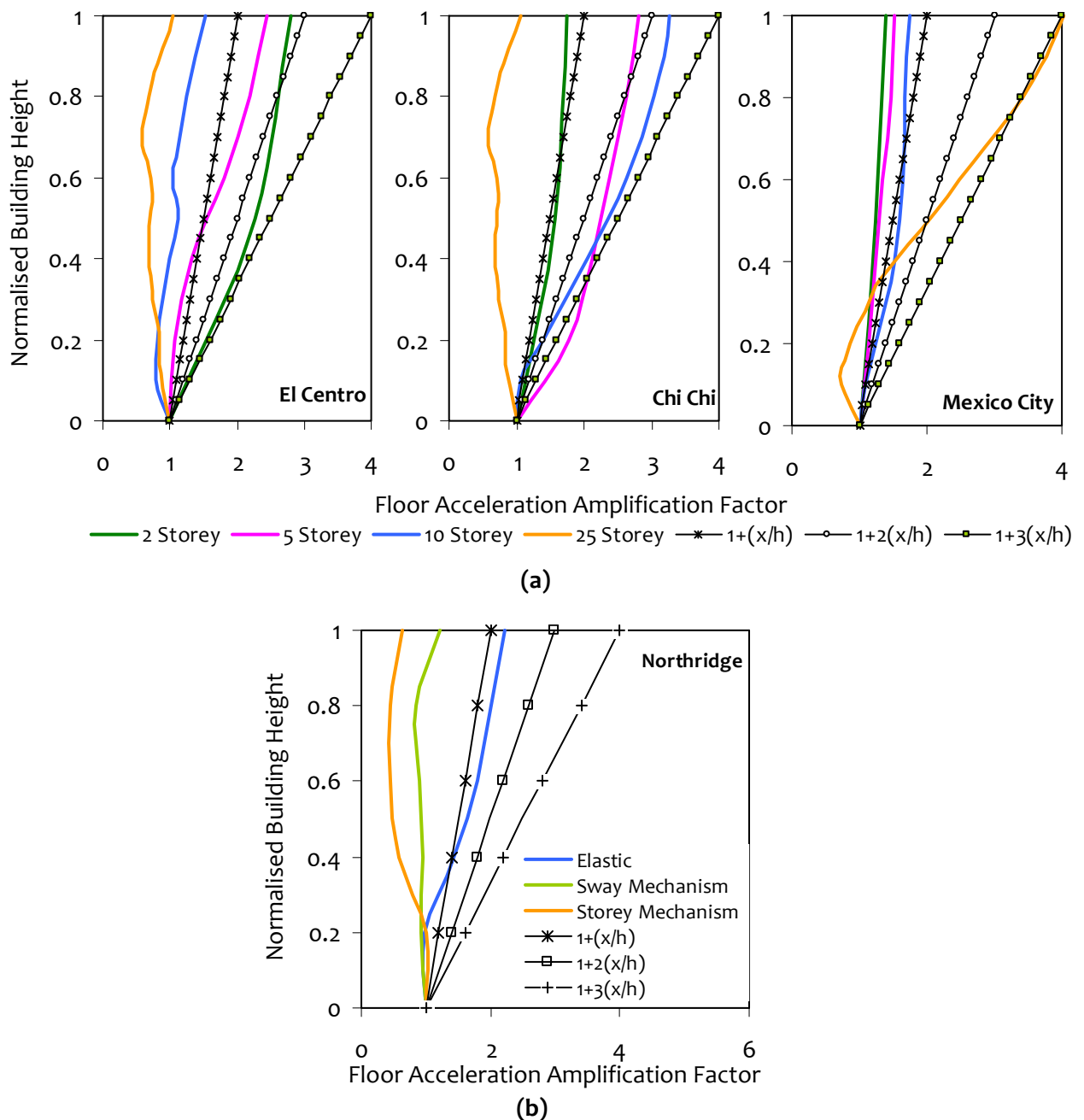
**Figure 5.4:** Floor Acceleration Response of Buildings: Floors receive different levels of shaking depending on characteristics of the building

**Table 5.10:** Proposed Importance Factors  $I_p$  of NSEs

NSE	$I_p$
Component containing hazardous contents	5.0
Life safety component required to function after an earthquake (e.g., fire protection sprinklers system)	5.0
Storage racks in structures open to the public	5.0
All other components	4.0

For instance, consider four buildings, 2, 5, 10 and 25 storeys tall. When these buildings are subjected to three different ground motions (say, a far field ground motion represented by the 1934 Imperial Valley earthquake recorded at El Centro; a near field ground motion by the 1999 Chi Chi earthquake recorded at Station TCU052; and a special filtered ground motion by the 1985 Mexico City earthquake recorded at SCT A1 N90E), different characteristics are observed of the envelopes of floor accelerations generated in these buildings (Figure 5.5). Figure 5.5a shows variation of floor accelerations considering *elastic behaviour* of these buildings. Also, shown are approximate variations of floor accelerations of  $(1+z/H)$ ,  $(1+2z/H)$  and  $(1+3z/H)$  times the ground acceleration as used by different design codes. None of the approximate variations adequately represent actual variation of floor acceleration along building height of ALL the twelve combination cases (of 4 buildings and 3 ground motions).

Figure 5.5b shows amplification in floor acceleration compared to *peak ground acceleration* in the 25-storey building alone subjected to 1994 Northridge earthquake ground motion (Sylmar 7 Station), considering both *elastic* and *inelastic* behaviours. Two types of inelastic conditions are considered, namely plastic hinges formed in beams only (representing sway mechanism), and plastic hinges formed primarily in columns (representing a case of storey mechanism as in weak open storey buildings). Clearly, the accelerations at the floor levels *reduce* when the behaviour of the building is *inelastic* from those when the behaviour is *elastic* [Villaverde, 1998; Adam and Fotiu, 2000; Chaudhari and Villaverde, 2008; Chaudhari and Hutchinson, 2011]. Some seismic codes for design of buildings also recognize that the variation of lateral forces is a function of natural period of the building. The large variation in building geometries, structural systems, roles of natural modes of vibration, frequency content of ground motions, and levels of inelasticity achieved in different code designed buildings, are some reasons for not being able to decisively conclude and identify the most accurate floor acceleration distribution to be used in design of NSEs.



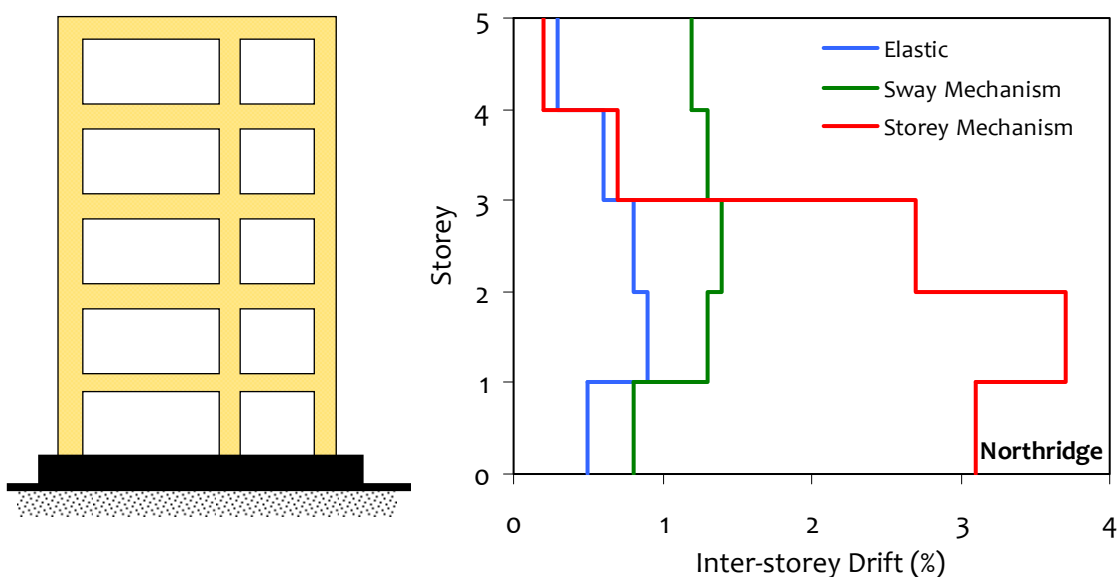
**Figure 5.5:** Floor accelerations in buildings of different heights: (a) Elastic behaviour, and (b) Inelastic behaviour

The relative lateral displacement between floors is *higher* when the behaviour of the building is *inelastic* in contrast to the observation that the floor acceleration is smaller when the building undergoes inelastic behaviour. Figure 5.6 shows this for a 5-storey building. Three cases are shown, namely elastic building, inelastic building with beam sway mechanism of collapse, and inelastic building with storey mechanism of collapse. When plastic hinge actions are concentrated in columns (storey mechanism), the drift values are much higher; of course, this mechanism is not desirable. Thus, the design lateral force and design relative lateral displacement requirements for NSEs are governed by different behaviours of the building – *the former by elastic behaviour and the latter by inelastic behaviour of sway mechanism type.*

Other factors that may affect the behaviour of NSEs subjected to seismic action include torsion induced due to mass and/or stiffness as-symmetry, and flexible floor diaphragm action [Agarwal, 2000]. These factors are not discussed in this book, as it is presumed that all deficiencies in structural systems and their seismic design are addressed adequately, before undertaking design of NSEs.

**(d) Response Amplification Factor  $a_p$  of NSE**

Response amplification factor  $a_p$  of an NSE reflects its stiffness and mass effective in resisting shaking (Figure 5.7). Geometry and material properties of an NSE, and its connectivity with adjoining SE, together determine the stiffness. Depending on this stiffness (and hence flexibility), the amplification of the NSE differs when subjected to shaking at its base. Increased response of NSEs during earthquake shaking should be avoided by ensuring that their elastic natural frequencies are distinctly away from the band of frequencies expected at the floors on which they are mounted. In practice, this is achieved by mounting such NSEs on isolation devices. To understand the seismic behaviour and properly design these isolation devices, there is a need to study the contents of floor acceleration time histories of buildings having different dynamic characteristics and of NSEs having different dynamic characteristics. Both elastic and inelastic response of buildings and NSEs are in focus here.

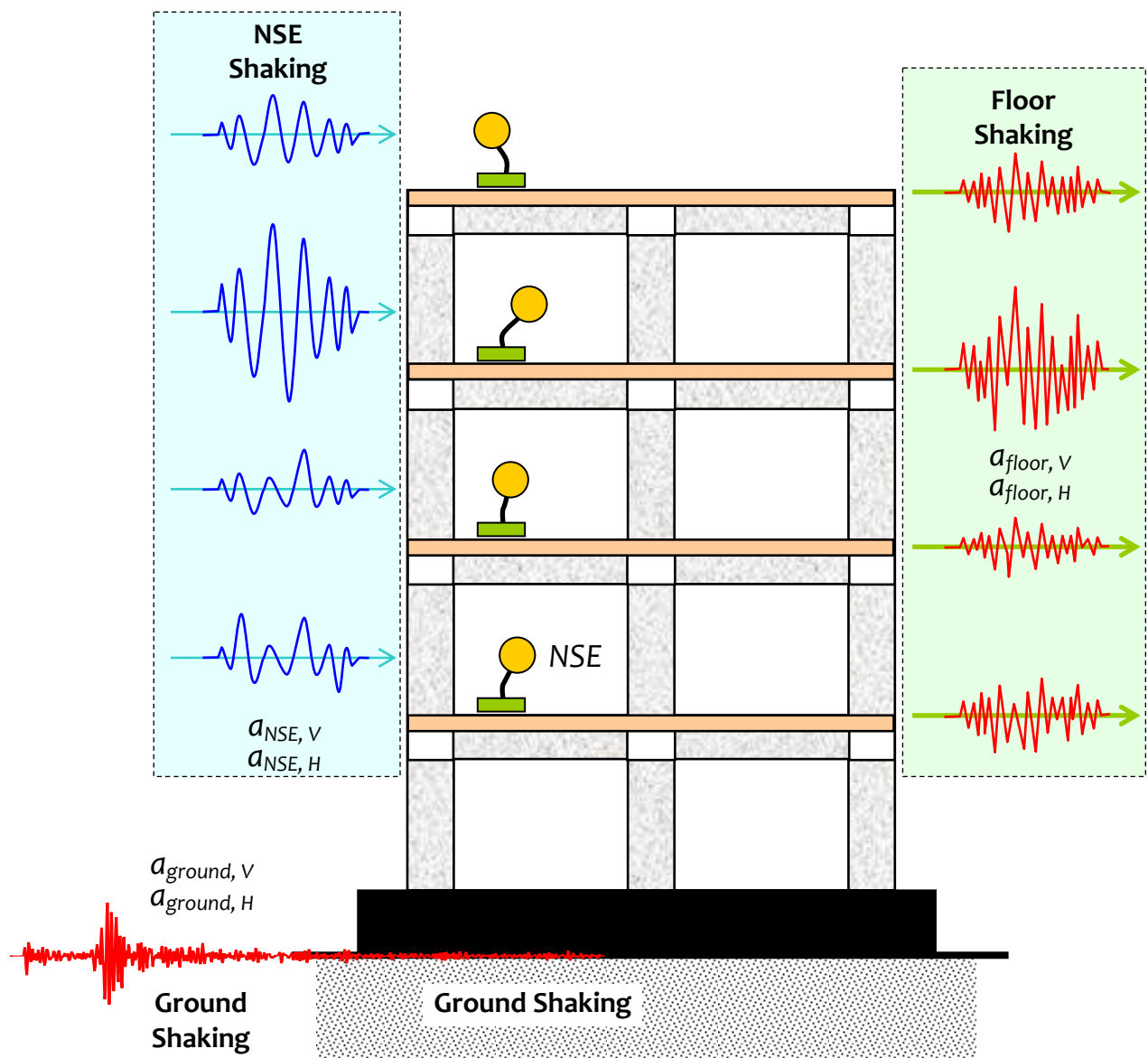


**Figure 5.6:** Inter-storey relative lateral displacement in a 5-storey building: Type of collapse mechanism governs the level of storey drift in buildings



### (e) Response Reduction Factor $R_p$ of NSE

Response reduction factor  $R_p$  assigned to or chosen for an NSE is based on the extent of ductility available in the NSE and its connection with adjoining SEs to resist inelastic actions. It depends on “*structural*” action within the NSE, and type of material used within the NSE as well as for connecting the NSE to adjoining SEs. It is prudent that manufacturers of NSEs provide adequate information regarding response reduction factors to be considered for NSEs based on thorough experimental and analytical investigations, and the rationale behind the judgement of choosing a certain value of  $R_p$  for a given NSE. Experimental and analytical time history studies (Figure 5.7) should be undertaken to arrive at these values. The use of  $R_p$  while estimating the design forces for acceleration sensitive NSEs implies that the designer is *allowing damage* to accrue in the NSE and/or its connection. This damage leading to permanent deformation may be detrimental to the functioning of critical NSEs after an earthquake event [Porush, 1990]. In retrospect, when the current design philosophy requires no damage to NSEs during minor and moderate seismic action, use of the Response Reduction Factor  $R_p$  directly *contradicts* the required objective that needs to be fulfilled. Further, use of Response Reduction Factor  $R_p$  eliminates additional reserve strength capacity which could have been used, should the demand experienced during an earthquake exceed the demand considered in design.



**Figure 5.7:** Acceleration Response of NSEs: NSEs pick up shaking from floor accelerations and respond based on their own dynamic characteristics

#### **(f) Component Importance Factor $I_p$ of NSE**

Higher value of importance factors  $I_p$  of NSEs are assumed to (a) make NSEs behave elastically and thereby reduce damage in NSEs, and (b) account for uncertainties associated with various parameters affecting the design of NSEs and their connections with adjoining SEs. Seismic codes specify an importance factor of 1.5 for critical NSEs. In view of the variability associated with different parameters used for the computation of design force, a flat prescription of 1.5 may not guarantee safety during an earthquake, especially of critical NSEs [Selvaduray, 1998].

#### **(g) Seismic Weight $W_p$ of NSEs**

While the mass of an NSE may not vary during an earthquake, the presence of vertical acceleration alters the effective vertical weight of NSEs; it can increase beyond its normal seismic weight  $W_p$ . This needs to be accounted for while determining the safety of an NSE, especially when the building is close to the fault systems, the NSE is a critical one, and for NSEs resting on a horizontal cantilever.

#### **(h) Connection of NSEs to SEs**

The strength and stiffness characteristics of connections of NSEs to SEs significantly affect the overall behaviour of NSEs (*e.g.*, see Section 3.4). In particular, the design strength  $F_p$  of the connectors as determined by Eq.(5.3) is to be appropriately chosen for both horizontal and vertical directions of shaking. For instance, for NSEs that are projecting out of horizontal surfaces of SEs,  $F_p$  is the horizontal force tangential to horizontal surfaces of SEs to which the NSEs are attached. And, for NSEs that are projecting out of vertical surfaces,  $F_p$  is the vertical force tangential to vertical surfaces of SEs to which the NSEs are attached. Undesirable behaviour of NSEs is expected if no such distinction is made in the estimation of the design lateral force  $F_p$  for connecting NSEs to vertical or horizontal surfaces of SEs.

#### **(i) Determining the Factors $R_p$ , $a_p$ and $I_p$**

Values of Response Reduction Factor  $R_p$ , Response Amplification Factor  $a_p$ , and Component Importance Factor  $I_p$  of NSEs currently used in design of NSEs, are based on *expert judgement*; this is based on understanding of past research on NSEs, brittleness of NSEs, sensitivity of NSEs, and performance of NSEs in past earthquakes. This is attributed to lack of detailed analytical studies on various NSEs and lack of experimental data from shake table tests on all prototype NSEs. Also, a large number of parameters influence these factors, and hence, it is difficult to derive simple expressions based on limited parameters that can be used in design. For commonly used NSEs in normal buildings and structures, this data may not become available, owing to the gigantic effort required to generate this data. Under these circumstances, expert judgement alone has been the available recourse, even though values adopted in codes are known to underestimate the amplification [Freeman, 1998; Marsantyo *et al*, 2000; Beattie, 2000; Horne and Burton, 2003]. On the other hand, for NSEs to be used in special, critical and lifeline buildings, a more serious approach has been adopted. NSEs intended to be used in these special cases, are *seismically pre-qualified* by subjecting prototype NSEs to shake table tests under a suit of ground motions. When these shake table tests are performed, the need for factors  $R_p$ ,  $a_p$  and  $I_p$  becomes redundant.

#### **(j) Type of NSE**

Earthquake behaviour of NSEs used for storing fluids (*e.g.*, water, and chemicals) tends to be different from those of NSEs used for storing solids (*e.g.*, books, and grains). When seismically excited, fluids undergo sloshing effect that may alter the demand imposed on the connection between NSEs and SEs [Tung and Kiremidjian, 1990], and thereby making such NSEs more vulnerable under seismic action. Experiences from past earthquakes also suggest that type of content stored in storage NSEs significantly influence behaviour of such NSEs. Several failures of NSEs have been reported due to sloshing effect during 1989 Loma Prieta earthquake [Perkins and Wyatt, 1990]. Secondary effects (such as sloshing) need to be considered while assessing demands on connections of NSEs to SEs, if applicable.

### 5.4.2 Design Relative Lateral Displacement for NSEs

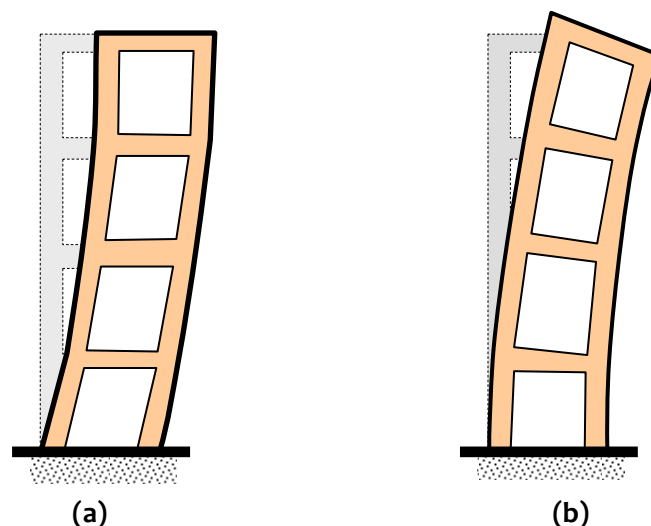
The latest code of USA [ASCE 7, 20120] has provisions for detailing relative displacements within buildings, and between two buildings; such requirements also exist in Indian provisions (Table 5.6 and Eqs.(5.4) and (5.5)). The method of estimation of design relative displacements is generic in ASCE 7. Subjectivity enters through the method of modelling and nonlinear (inelastic) structural analysis of buildings, including the choice of the ground motion considered for analysis. This method is in contrast to the seismic design guidelines of India, which uses an indirect method for estimating the inelastic deformations of the building, through the elastic deformations under design forces and the response reduction factor  $R$  of the building; the approach given in the Indian guidelines seems simpler, especially when designers do not have adequate background in nonlinear seismic analysis of buildings (Figure 5.3). But, even this method is based on grossly approximated method of estimating inelastic deformations using elastic deformation estimates. Some uncertainties are discussed here, associated with estimation of relative displacements within buildings.

#### (a) Higher Modes of Oscillation

Deformation profile of a building depends on its *height* as well as *elevation aspect ratio* (i.e., height-to-base dimension ratio). The behaviour of tall buildings is governed by higher modes of vibration. As a direct consequence, the relative displacement demand determined based on first mode of oscillation could be different from the actual deformation imposed during earthquakes. Hence, it is imperative that in tall buildings, deformation associated with higher modes of oscillation be considered while estimating design relative displacement demand on NSEs. Deformation demand estimated from fundamental mode may be sufficient for low rise buildings, as first approximation under elastic conditions.

#### (b) Relative Flexural Stiffness of Beams and Columns

Past studies on behaviour of buildings subjected to earthquake shaking have identified relative flexural stiffness of beam-to-column stiffness ratio as an important factor influencing deformation profile of buildings. Based on relative stiffness of beams and columns, building deformation profile obtained can be classified into two categories, namely (a) *shear deformation type*, and (b) *flexure deformation type* (Figure 5.8). The former predominates as ratio of flexural stiffness of beam to that of column *tends to INFINITY* and the latter when the ratio *tends to ZERO*. Intrinsic difference between these two deformation profiles lies in distribution of inter-storey drift along height of building. Variation of inter-storey drift along height of building decreases with height for *shear deformation type* building. On the contrary, it increases with height for *flexure deformation type* building. Hence, deformation demand imposed at the ends of *displacement-sensitive NSEs* differs with the variation of inter-storey drift in the building. Thus, variation of deformation profile of the building needs to be accounted for, by considering the relative flexural stiffness of beams and column in structural analysis, to ensure accurate estimate of the deformation demand on NSEs.



**Figure 5.8:** Lateral Deformation Type of Buildings: (a) Shear type, and (b) Flexure type

### (c) Axial Stiffness of Columns

Axial stiffness of columns also play vital role in determining whether the building deforms in *shear deformation type* profile or *flexural deformation type* profile (Figure 5.8). Flexural deformation type profile predominates in buildings with *low axial stiffness of columns*, and shear deformation type in buildings with *high axial stiffness of columns*.

### (d) Inelastic Action in Buildings

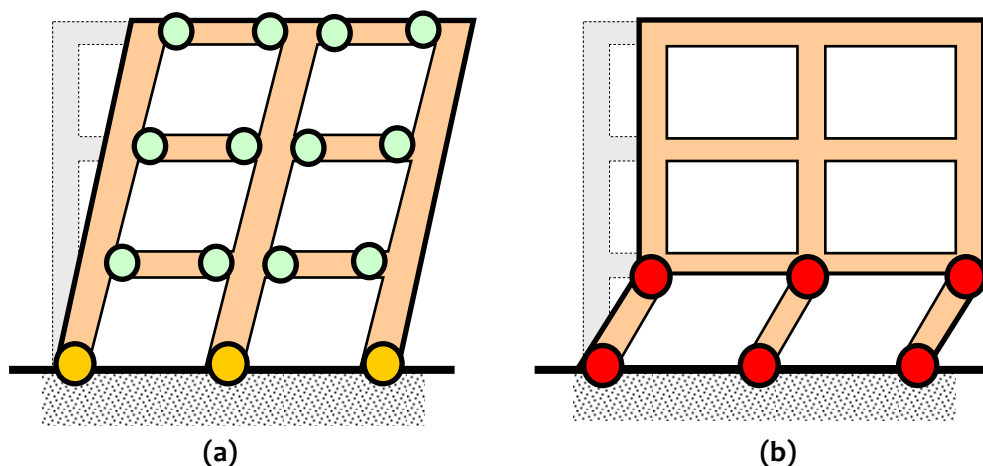
With increase in inelastic action, deformation demand imposed on *displacement-sensitive NSEs* may increase or decrease. When a building is designed to undergo some inelastic actions when subjected to design level earthquake shaking, the extent of inelasticity depends on *Response Reduction Factor R* used in the design of the building. In its simplest form, some codes [e.g., IS:1893 (Part 1), 2007] suggest that the enhanced deformation demand imposed due to inelastic action may be quantified as  $R$  times the elastic deformation (estimated under design lateral load obtained from *linear elastic* structural analysis, Figure 5.3). Hence, the inelastic deformation is a function of elastic deformation under design loads. Here, there is an underlying assumption that distribution of inelastic deformation along the building height is same as that of elastic deformation. But, the magnitude and distribution of inter-storey drift along the height of a building under inelastic conditions depend on (i) type of failure mechanism (sway mechanism, storey mechanism and mixed mechanism; Figure 5.9), and (ii) distribution of inelastic action along the height of the building. In tall buildings, the inelastic action may well be concentrated in lower portions, while the upper portions may remain elastic; under such circumstances, the inter-storey drifts imposed on the lower portions (where inelastic actions are severe) may be significantly higher than those imposed on the upper portions (where inelastic actions are absent or negligible).

### (e) Building Irregularities

Effects of building irregularities (such as mass and/or stiffness irregularity in plan and/or elevation, and strength irregularity along height and/or plan of building) influence the magnitude and distribution of demand imposed on displacement-sensitive NSEs. It is possible that the building may be excited in the torsional mode, depending on the extent and distribution of irregularity. Excitation of torsional mode of building may lead to enhanced demand on the displacement-sensitive NSEs. In tall buildings, usually storey stiffness reduces upwards with height. Such decrease in storey stiffness may lead to enhanced deformation demand at upper levels.

### (f) Soil-Structure Interaction

Including *Soil-Structure Interaction* in structural analysis is critical in estimating realistic deformation demands on displacement-sensitive NSEs in buildings, particularly when buildings are supported on soft and flexible soil. The deformation demand on such buildings may increase, which in turn may lead to significant enhancement in the demand for displacement-sensitive NSEs, especially those spanning between two buildings.



**Figure 5.9:** Two Basic Mechanisms of Inelastic Actions in Buildings: (a) Beam mechanism, and (b) Column mechanism

### (g) Connection between NSEs and Buildings

When displacement-sensitive NSEs either are snugly held at their ends by SEs or at multiple locations by restrainers anchored to SEs, significant damage was noted during past earthquakes. For instance, many failures of piping and sprinkler systems were observed at the connection between NSEs and buildings during 1994 Northridge earthquake. Currently, design provisions do not exist for the design of *displacement-sensitive NSEs* connected at multiple locations by restrainers. In fact, it is essential to outline separate provisions for NSEs held at multiple locations, because displacement demands imposed on NSEs with multiple support conditions can be different from those imposed on NSEs when they are restrained at only two supports.

## 5.5 LIMITATIONS OF ANALYSIS METHOD

The two commonly used methods for protecting NSEs by the *Engineered Strategy*, namely the *Floor Response Spectrum Method* and the *Complete Model Method* are used depending on the importance laid on the interaction between response of NSE and the building on which it is mounted. Most design codes use the *Floor Response Spectrum Approach* for seismic analysis and design of NSEs. The inherent assumptions and limitations of this procedure are:

- (a) The dynamic responses of NSEs do not *significantly* affect seismic response of buildings to which they are attached. But, this is true only under *two major conditions*, namely,
  - (i) when mass of NSE is small compared to (a) mass of the floor to which it is attached, and (b) mass of the whole building, and
  - (ii) when natural period of oscillation of the NSE is reasonably far off from (a) natural period of floor to which it is attached, and (b) fundamental period of the whole building.Thus, for instance, anchorage of heavy water tanks on roof top cannot be designed by this approach, because the mass of fully-filled tanks can be comparable to that of the roof (floor) to which it is attached. In such cases, inertia force induced in tanks may significantly affect the dynamic behaviour of the building.
- (b) Both the building to which NSE is attached and the NSE are *elastic*. This is not necessarily true. Although inelasticity in the NSE is later addressed through the  $R_p$  factor, the floor response amplification along building height does not account for the inelasticity in the building; any departure from elastic behaviour of the building changes the floor response spectrum, and hence, the response of the NSE, especially the displacement-sensitive NSEs.
- (c) The supporting building oscillates in its fundamental mode that is often approximated as having a linear variation along the building height in design codes. This is not true in tall buildings, in which higher mode effects can be considerable. Further, any *inelasticity* induced in the building during seismic shaking undeniably changes the floor acceleration response variation along building height compared to that under *elastic actions*.
- (d) The building does not undergo significant torsion during earthquake shaking. Again, this need not be true in buildings with poor seismic configuration, and this can affect the variation of floor response along the building height.
- (e) There is *no cross-correlation* between the motions at the different supports when NSEs are on multiple supports, especially those that are supported at different levels of buildings. Cross-correlation refers to the effect where the response of one support of a multi support NSE affects the response of the building, which in turn affects the response of the other supports of the NSE. For example, consider the fire hydrant water main in a building, which arrives from outside the building to the first floor of the building. This main is supported on the ground and at the first floor levels. It is subjected to differential shaking at its two ends, which need not be correlated.

In addition to the above, two major uncertainties that affect the estimate of response of NSEs are (i) *characteristics of the input earthquake ground motion*, and (ii) *possible soil-structure interaction at the base of the building*. These two uncertainties are commonly addressed by *broadening* of the peak spectrum by about 15% based on engineering judgement [USNRC, 1978], or by using an upper bound of imposed demand through use of *combined* or *envelop* spectrum. Despite all of the above assumptions, most design codes still use the *Floor Response Spectrum Approach* for seismic analysis

and design of NSEs, owing to simplicity of the method and ease of its use in design offices in being able to handle separately the responses of buildings and of NSEs.

Acknowledging that certain *contents of buildings, appendages to buildings and services & utilities* may significantly alter the seismic response of the supporting building, the next level of sophistication in analysis uses *Complete Model Method*. As stated earlier, the building is modelled along with the NSEs (that include contents, appendages, and services & utilities); they are analysed *together*. Although more robust, there are inherent challenges of this method also. Some of these are:

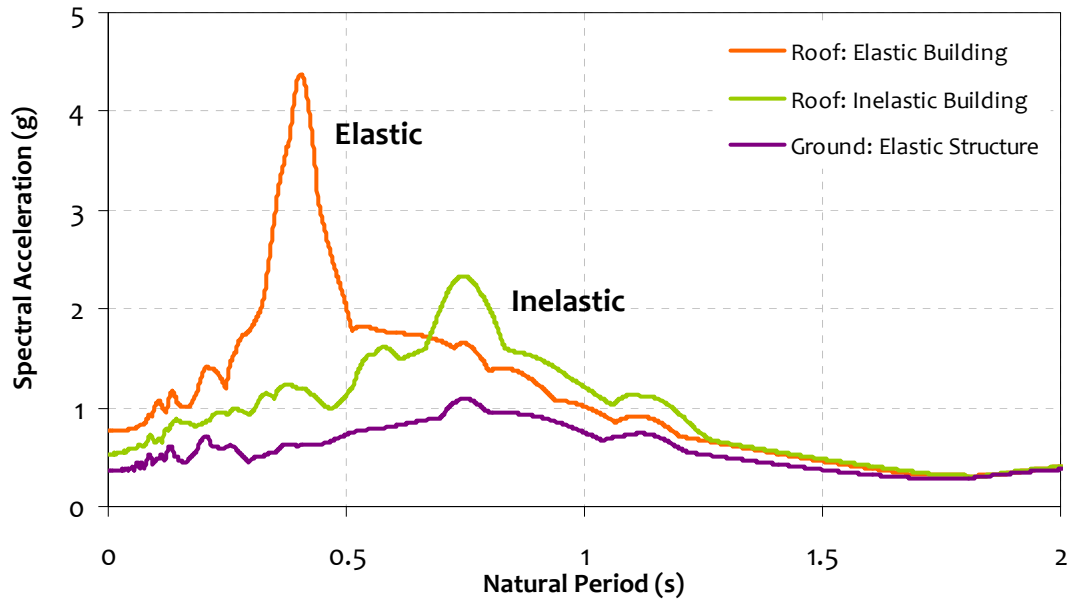
- (a) Modal damping of the combined system is involved that is considerably different from that of buildings. If the same approach as adopted for buildings is used for NSEs also, it leads to inaccurate or expensive numerical analysis;
- (b) Increased degrees of freedom of the combined model used in analysis, leads to inefficient numerical analysis;
- (c) This method requires iterations to design of both building and NSEs in it, because a change in properties of NSEs and their connections with SEs alters demand on building, and *vice versa*;
- (d) This method is difficult to use in routine design of structures by practicing engineers; and
- (e) It is assumed that both the building and the NSEs are *elastic*, which is not necessarily true.

Despite the above limitations, adopting the *Complete Model Method* may be important in design of critical facilities, because it provides more realistic estimates of responses of both building and NSEs, when challenges mentioned in the preceding paragraph are overcome.

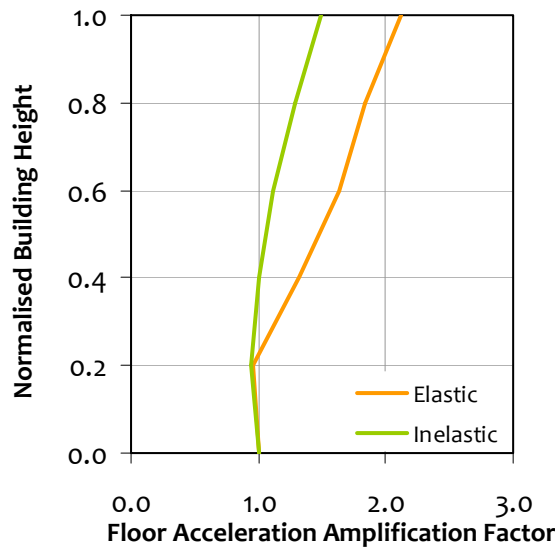
## 5.6 IMPORTANCE OF CAPTURING NONLINEAR BEHAVIOUR OF BUILDINGS IN DESIGN OF NSEs

Current methods of analysing seismic behaviour of a NSE assume linear behaviour of both the NSE and the building on which it is mounted. Studies have shown that this assumption is not necessarily true for NSEs. Already, it is well established that most *normal buildings* undergo large nonlinear actions during strong earthquake shaking; in fact, the premise of earthquake resistant design of buildings expects inelastic actions in normal buildings. On the other hand, even in *critical & lifeline buildings*, which are expected to be fully functional for immediate use after strong earthquake shaking and to behave largely elastically, NSEs may undergo inelastic actions. Capturing these nonlinear actions in either the building or the NSE is a major step that needs to be taken by researchers towards improved protection of NSEs during strong earthquake shaking, be it in *normal buildings* or in *critical & lifeline buildings*.

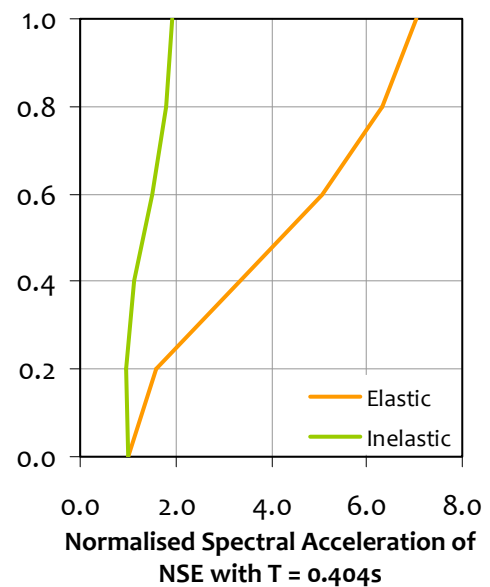
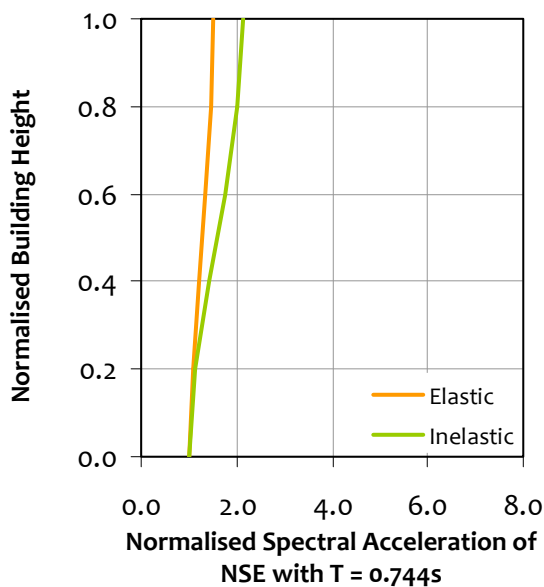
Consider a 5-storey RC frame building with 4 bays in one plane direction and 3 bays along the other. The columns are so designed that all inelasticity, if any, is restricted only to end of beams through ductile flexural actions. The building is subjected to the 1994 Northridge earthquake ground motion (Sylmar 7 Station). Floor acceleration response spectra (at roof level) obtained are shown in Figure 5.10. Floor acceleration response spectra  $S_a/g$  shows lengthening of natural period of building from 0.404s to 0.744s under inelastic actions, represented by peaks of spectral acceleration spectra at these periods. Also, inelastic actions of the building (not elastic actions) govern design force for *force-sensitive* NSEs having natural period more than about 0.6s. Alongside, Figure 5.11a shows variation of peak floor accelerations (normalised with peak ground accelerations) along the height of the building. The elastic actions alone seem to govern and not inelastic actions. But, Figure 5.11b shows otherwise; it shows variations in floor acceleration response spectral values  $S_a/g$  corresponding to natural periods of 0.404s and 0.744s. As in case of floor acceleration response spectra at the roof, elastic actions of the building govern for NSEs with natural period 0.404s, while inelastic actions govern for those with natural period 0.744s. In summary, some NSEs may be governed by elastic behaviour of building, while others by inelastic behaviour.



**Figure 5.10:** Roof Acceleration Response Spectra: Inelastic response shows lengthening of dominant natural period of the building (response spectrum of the ground motion shown for comparison)



(a)



(b)

**Figure 5.11:** Variation in Acceleration values along height of building: (a) Peak Floor Acceleration values, and (b) Floor Acceleration Response Spectral values

## 5.7 RESEARCH NEEDED

The uncertainties involved in analysis and design of NSEs are many, and consequently, most design codes today adopt simple approximate solutions to provide at least a certain minimum level of protection to NSEs. Clearly, post-earthquake investigations have shown that the design provisions have fallen short in protecting some NSEs. The uncertainties that code writers are grappling with can be broadly grouped into three categories, namely

- (i) Uncertainties in characteristics of input earthquake ground motion,
- (ii) Uncertainties in elastic and inelastic nonlinear response of the supporting building, and
- (iii) Uncertainties of the NSEs themselves.

Rigorous research is needed to reduce and/or eliminate at least some of these uncertainties. The focus areas for research effort could include:

### (1) *Input Ground Motion Characteristics*

- (a) Effect of far field *versus* near fault motions on behaviour of buildings and NSEs;
- (b) Effect of amplitude and duration of earthquake shaking on performance of NSEs; and
- (c) Effect of travel path and local site condition on behaviour of buildings and NSEs.

### (2) *Elastic & Inelastic Nonlinear Response of Supporting Building*

- (a) Effect of structural configuration;
- (b) Effect of inelasticity in buildings and NSEs; and
- (c) Effect of base isolation and other active and passive methods of protecting buildings and NSEs.

### (3) *Type, Nature, Anchorage and Response of NSEs*

- (a) Effect on different varieties of NSEs (*i.e.*, of different size, shape, mass, and use), and types of NSEs (*i.e.*, force-sensitive NSEs and or displacement-sensitive of NSEs); and
- (b) Effect of different anchorage systems, *i.e.*, elastic, brittle, ductile.

In particular, it is important to determine (through both analytical and experimental research) the stiffness, damping, ductility, allowable acceleration, and allowable drift limits at which the variety of NSEs used in daily life cease to be operational. Further, the suitability of the current and newly developed securing methods needs to be evaluated. All these need to be undertaken with the aim of (a) developing simple rational methods that are accurate enough to be incorporated in building design codes for *engineered practice* of not so common and critical NSEs, and (b) developing *pre-engineered practice* for all possible standard NSEs used in daily life.

## 5.8 IMPORTANCE OF SEISMIC PRE-QUALIFICATION OF NSEs

*Critical & lifeline buildings* (*e.g.*, buildings housing schools, hospitals, fire stations, telephone exchange, and administration) are required to be functional following a major earthquake. In most cases, functionality of these buildings depends upon the performance NSEs in addition to that of SEs during the earthquake. Thus, it is imperative that NSEs in critical buildings are fully functional in the aftermath of an earthquake. Loss of function of NSEs leads to severe disruption in the functioning of associated critical services. For instance, the Olive View Hospital in Sylmar, California, had to be evacuated due to failure of sprinkler system after 1994 Northridge earthquake [EERI, 1997].

In general, NSEs are composed of many sub-parts that are functionally and physically inter-related to each other (Figure 4.14). For effective functioning of NSEs, all these components should perform as expected. Hence, it is essential to ensure that failure of one component of NSE may not lead to the entire NSE being non-functional through seismic pre-qualification [Roth, 1999]. When NSEs (both *force-sensitive* and *displacement-sensitive* NSEs) are subjected severe ground shaking, they can fail in two ways, namely

- (a) Anchoring elements that connect NSEs to SEs can fail, or
- (b) Internal sub-parts of properly anchored NSEs can fail.

In essence, overall seismic performance of NSEs is governed both by the performance anchorage of NSEs to SEs, as well as the performance of individual components of NSEs [ATC 29, 1990].



When NSEs consist of a number of sub-parts, it is not easy to prepare a detailed finite element model of NSEs with their mass, stiffness, damping characteristics and intricate connection details between the sub-parts. Thus, the model becomes insufficient to capture inelasticities that generate during earthquake shaking. Further, the ever increasing number of NSEs in buildings and structures makes it difficult for designers to design each and every NSE for the required design force (imposed during seismic action). Majority of NSEs used in commercial, institutional and critical facilities are mass produced, *i.e.*, these NSEs are produced based on some predefined industrial requirements and standards. Effort required on the part of designers to *secure* such NSEs may be considerably reduced, if manufactures of these standard NSEs undertake detailed R&D studies to study earthquake response of these NSEs under different ground motions, and provide prescriptive details to secure the NSEs to SEs for determined levels of seismic actions that are considered suitable for the region in which the NSE is used. Manufacturers of delicate and expensive NSEs already are doing this by *experimental studies* on prototype NSEs subjecting such NSEs to real-time earthquake shaking that is expected at the base of the NSE or between its ends. This approach eliminates all assumptions and approximations that are usually resorted to in analytical study of earthquake performance of NSEs.

Some design codes mandate (*e.g.*, ASCE 07-10) designers proposing the use of certain critical NSE to submit *manufacturer's certificate* that the NSE (along with its internal sub-parts) is *seismically pre-qualified (experimentally)*, and the method and details of connecting the NSE to the SE. This is mandated in addition to submitting appropriate design calculations to demonstrate that the manufacturer-specified connection details are correct. In generic NSEs, it is considered sufficient, if the *manufacturer's certificate* is made available before using the NSE. Manufacturer's certificate is deemed to be acceptable, if and only if, it is based on at least one of the following:

- (a) Detailed nonlinear analysis of NSE and its connection to the SE;
  - (b) Experience data based on nationally recognized procedure; or
  - (c) Testing in accordance with recognized test procedures [ICC-ES AC 156, 2007; FEMA 461, 2007].
- Further, seismic pre-qualification (through experimental studies on prototype NSEs) is a *must* for NSEs that are used in containment of hazardous substances and all important NSEs, *i.e.*, NSEs that are designed with an importance factor greater than 1.0.

The main issues related to seismic certification and pre-qualification of NSEs are that

- (i) The process should be based on series of seismic pre-qualification tests to evaluate performance of standard NSEs and not based on ad-hoc assumptions, and
- (ii) Adequate to encompass variability associated with onsite conditions, *e.g.*, soil condition of the building in which NSE is supported, characteristics of building, location at which it is supported along height of building, and characteristics of the NSE.

Although seismic pre-qualification of NSEs require overwhelming task of determining the seismic demand under widely variable scenarios, its final objective is to provide simple and easy-to-follow viable alternate prescriptive methods by which NSEs can be secured!

NSEs in critical buildings, that are required to be fully operational following an earthquake, are required to be certified *solely* on the basis of approved *shake table test* procedures. One advantage of shake table test is that it allows assessment of NSEs that are too complex to be realistically simulated to obtain their realistic earthquake performance, particularly when the entire system needs to be evaluated (*e.g.*, the NSE along with force resisting anchorage system affixed onto the SE of the building). Likewise, standard NSEs in normal buildings need to be certified on the basis of approved *shake table test* procedures. Another advantage of undertaking shake table test is that it allows assessment of performance of NSEs even in their nonlinear behaviour range. Seismic protection of commonly used force-sensitive NSEs, like cupboards and bookshelves, can be ensured by pre-qualification of securing devices of these NSEs by the *manufacturer*.

Shake table test regime for seismic pre-qualification of *force-sensitive NSEs* should include [FEMA 454, 2006]:

- (a) Estimating properly the seismic demand based on hazard associated with different regions;
- (b) Assessing end user requirements pertaining to functionality of NSE immediately after earthquake;
- (c) Setting criteria for acceptable performance limits of the NSE considering the factors that might influence the behaviour of the NSE subjected to seismic actions by performing detailed finite element studies to evaluate structural, modal and spectral characteristics of the NSE;
- (d) Performing *bi-axial shake table tests* on representative NSE models using standard test practice;
- (e) Evaluating performance of the NSE base on outlined criteria;
- (f) Prescribing and re-evaluating engineered methods to secure the NSE;
- (g) Monitoring performance of secured NSE in future earthquake events; and
- (h) Preparing and making available detailed reports consisting data pertaining to performance of the NSE during earthquakes, finite element studies, and shake table tests.

As a consequence of the seismic pre-qualification procedure, *simple-to-use user manuals* need to be prepared and made available by manufacturers of standard NSEs. Such manuals should demonstrate the way to secure such NSEs by use of additional fixtures provided along with these NSEs [Meyer *et al*, 1998]. Different fixtures, with different set of instructions may be developed, for the use of the same NSE in different seismic zones.

In much the same way, seismic pre-qualification of *displacement-sensitive NSEs* should include:

- (a) Studying and evaluating performance of such NSEs in past earthquakes;
- (b) Undertaking detailed nonlinear finite element analysis studies; and
- (c) Performing dual-table bi-axial/tri-axial shake table tests.

...

## Chapter 6

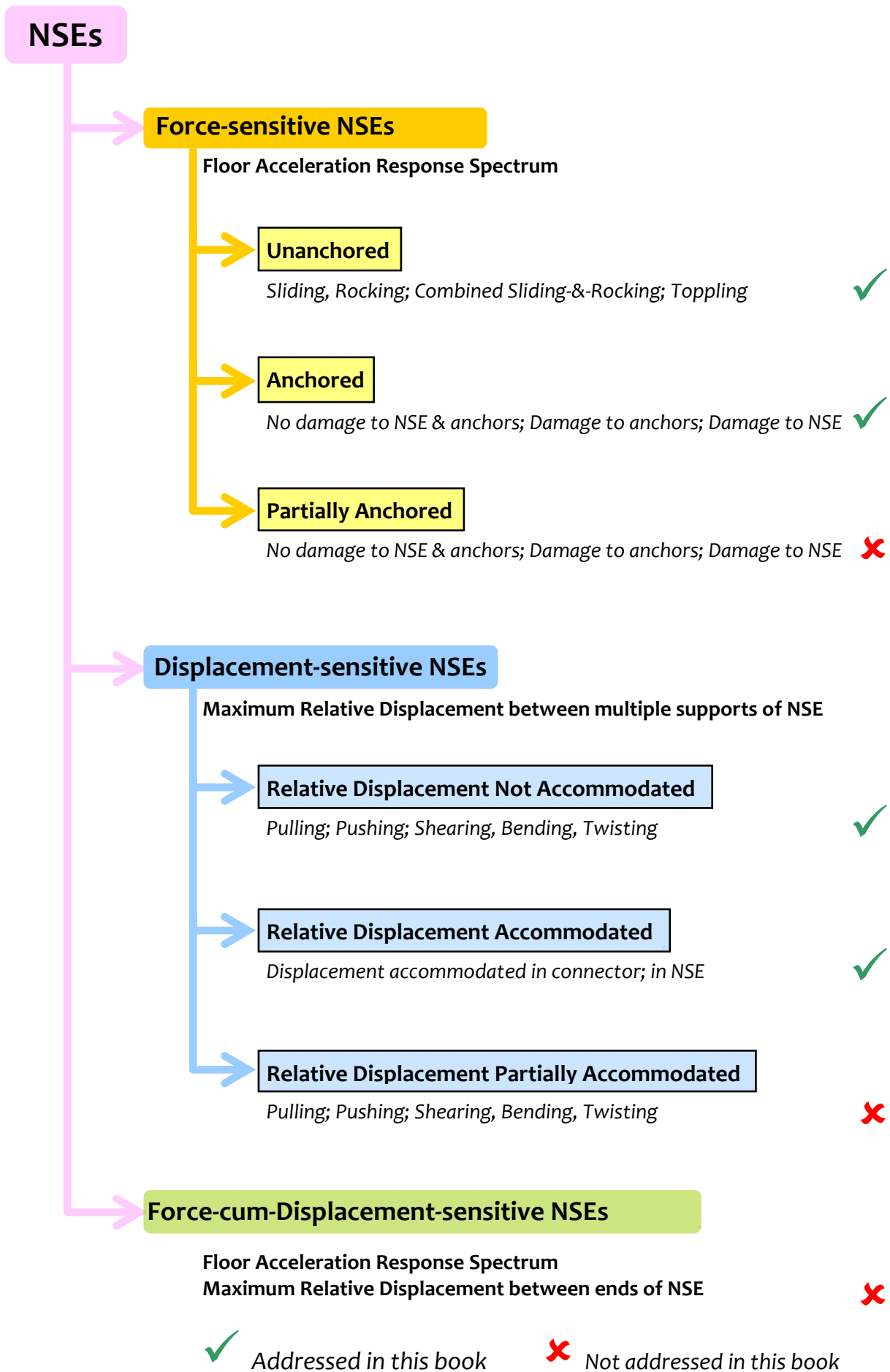
# Looking Back to Look Ahead

### 6.1 SUMMARY

Rising costs of Non-Structural Elements in building projects have made it imperative to give due attention to earthquake protection of NSEs. This book is an attempt to put together available literature on earthquake protection of NSEs and present the same in five relatively independent chapters in a simple way to first time readers of the subject.

Overall earthquake performance of a building largely depends *first* on the earthquake performance of SEs, and then on that of NSEs. *Desirable seismic performance of NSEs cannot be ensured by any amount of design of NSEs and of their connections to SEs unless the SEs perform well during earthquake shaking.* For instance, if two parts of a building pound on each other at the construction joint, the impact imparts high acceleration pulses of short-period (even up to 10 times larger accelerations that are generated normally at floors without any pounding), especially at floors that are pounding on each other, which can lead to failure of delicate NSEs (of short-periods) mounted on them. Therefore, it is imperative that adequate design strategies and suitable preventive measures are taken to reduce, if not eliminate, the likelihood of pounding [Scawthron *et al*, 1990; Kasai *et al*, 1990]. Clearly, if pounding is at higher elevations, the associated peak acceleration of the floor is larger; also, accelerations on the same floor reduce at distances away from the point of pounding. Even if attempts are made to locate NSEs away from possible locations of pounding, design NSEs to have longer natural periods, or use isolation devices to filter the high frequency waves, it is NOT possible to completely negate the ill-effects of pounding. Similarly, commonly used infill masonry walls in moment frames often are damaged during earthquakes, when they are isolated from the frame. In such cases, damage to the infill wall (*i.e.*, out-of-plane collapse) will lead to falling and breaking of wall mounted NSEs, like air-conditioner units and television sets; any amount of design of the connections of these NSEs to the walls will not ensure their earthquake safety when the wall itself is unstable. Likewise, inelastic actions in a storey of a building cause increase in inter-storey drift demand between the ends of NSEs that run between the floors above and below, and may cause dysfunctionality or breakage of such NSEs (*e.g.*, ducts). This book reiterates that earthquake protection of NSEs is a second effort, only to be undertaken *after* ensuring that buildings (and SEs) on which they are mounted are themselves earthquake-resistant to begin with.

The items discussed in this book are related to behaviour and design of the two basic types of NSEs, namely *force-sensitive NSEs* and *displacement-sensitive NSEs*. Details of items covered in this book are depicted in Figure 6.1.



**Figure 6.1:** NSE Protection: Behavioural and design aspects presented in this book

## 6.2 CLOSING COMMENTS

Designing an NSE and its connections with SEs is a two stage effort, to resist earthquake shaking effects efficiently, namely (1) *Safety Design*, and (2) *Economy Design*. Understandably, the *first* effort is to ensure that the NSE performs satisfactorily under the expected intensity of earthquake shaking by developing primary design provisions and including them in design codes, and ensuring their compliance. And, the *second* effort is to improve the design of the NSE and its connection with SEs, by advanced and detailed analyses and experimental studies, eventually leading to refined code provisions. The components of these two earthquake protection sub-cycles are shown in Figure 6.2.

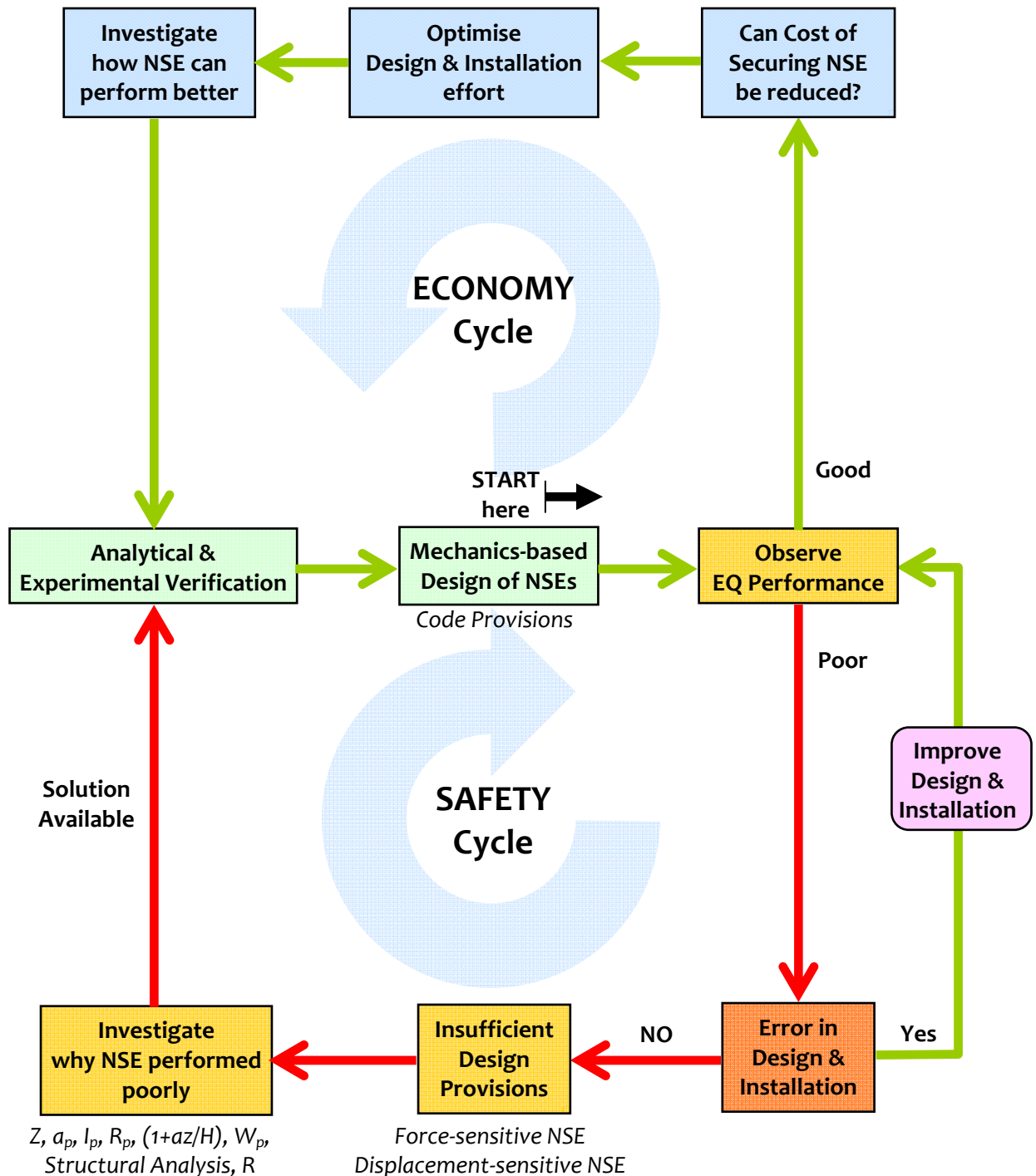


Figure 6.2: NSE Protection Cycle: Economy Design is undertaken only after Safety Design is satisfied

In countries where earthquakes occur rather frequently (like USA), there are adequate opportunities for verifying designs of NSEs (and their connections to SEs) to resist earthquakes, as evident from the rather systematic development of design provisions for *force-sensitive* and *displacement-sensitive* NSEs in such countries based on formal verification of earthquake performances. In USA, development of design provisions for *force-sensitive* NSEs started in early 1930s, but the same for *displacement-sensitive* NSEs started only in 1980s. This also coincides with alarmingly large increase in costs of NSEs during 1970s and 1980s in USA (Figure 1.22). But, in countries (like India), where the frequency of occurrence of earthquakes is not as high, there is no motivation for ensuring development and improvement of seismic design provision for NSEs. In India, the problem is even more complicated. Seeking earthquake safety of buildings is the current focus of all techno-legal and techno-financial initiatives in India. Therefore, earthquake protection of NSEs requires even more focused efforts to bring the matter to the attention of all stakeholders in the country. Also, the expensive NSEs being used in buildings since the 2000s have not been tested by any strong and damaging earthquakes. Thus, even though India and such countries do not have seismic design provisions for protecting NSEs, the increased cost share of NSEs in building projects is alarming enough to urgently bring such provisions in the design codes of such countries.

NSEs in *special and critical & lifeline structures* (e.g., select chemical industries, hospitals, and governance structures) are assuming increased attention. The post-earthquake performance of these facilities require higher levels of engineering design and implementation effort. This is likely to increase the cost of NSEs. But, looking at the gain of having these NSEs functional in the post-earthquake scenario, the increased initial cost is justifiable.

It is encouraging that despite uncertainties in estimating the seismic hazard and in understanding the detailed elastic and inelastic behaviour of buildings and NSEs, countries with advanced seismic provisions have managed to reduce losses in NSEs due to effects expected during earthquake shaking by adopting *mechanics-based design strategies, rigorous experimental investigations & verifications, and strict implementation.*

...

## References

- Adam,C., and Fotiu., (2000), "Dynamic Analysis of Inelastic Primary-Secondary Systems," *Engineering Structures*, Vol.22, pp 58-71
- Agrawal,A.K., (2000), "Response of Light Equipment on Torsional Building with Passive Mass Damper," *Computers and Structures*, Vol.78, pp 591-602
- Akhkaghi,H., and Moghadam,A.S., (2008) "Height-Wise Distribution of Peak Horizontal Floor Acceleration (PHFA)," *Proceeding of 14<sup>th</sup> World Conference on Earthquake Engineering*, Beijing, China
- Anderson,J.C., and Bertero,V.V., (1986), "Uncertainties in establishing design earthquakes," *Journal of Structural Engineering*, American Society of Civil Engineers, Vol.113, pp 1709-1724
- ASCE/SEI 7-10, (2010), *Minimum Design Loads for Buildings and Other Structures*, American Society of Civil Engineers, Reston, Virginia, USA
- ASCE/SEI 7-05, (2005), *Minimum Design Loads for Buildings and Other Structures*, American Society of Civil Engineers, Reston, Virginia, USA
- ASCE/SEI 7-02, (2002), *Minimum Design Loads for Buildings and Other Structures*, American Society of Civil Engineers, Reston, Virginia, USA
- ASCE/SEI 7-98, (1998), *Minimum Design Loads for Buildings and Other Structures*, American Society of Civil Engineers, Reston, Virginia, USA
- ASCE/SEI 7-95, (1995), *Minimum Design Loads for Buildings and Other Structures*, American Society of Civil Engineers, Reston, Virginia, USA
- ASCE/SEI 7-88, (1988), *Minimum Design Loads for Buildings and Other Structures*, American Society of Civil Engineers, Reston, Virginia, USA
- Aslam,M., Godden,W.G., and Scalise,D.T., (1980), "Earthquake rocking response of rigid bodies," *Journal of Engineering Mechanics*, American Society of Civil Engineers, Vol.106, pp 377-392
- ATC 29, (1990), *Proceedings of Seminar and Workshop on Seismic Design and Performance of Equipment and Nonstructural Elements in Building and Industrial Structures*, Applied Technology Council, CA, USA
- ATC 29-1, (1998), *Proceedings of Seminar on Seismic Design, Retrofit, and Performance of Nonstructural Components*, Applied Technology Council, CA, USA
- ATC 29-2, (2003), *Proceedings of Seminar on Seismic Design, Performance and Retrofit of Nonstructural Components in Critical Facilities*, Applied Technology Council, CA, USA
- ATC 69, (2008), *Reducing the Risks of Non-Structural Earthquake Damage: State-of-the-Art & Practice Report*, Applied Technology Council, CA, USA
- Beattie,G.J., (2000) "The Design of Building Services for Earthquake Resistance," *Proceedings of 12<sup>th</sup> World Conference on Earthquake Engineering*, Paper No.2462, Auckland, New Zealand
- Chaudhuri,S.R., and Hucthinson,T.C., (2004), "Distribution of Peak Horizontal Floor Acceleration for Estimating Nonstructural Element Vulnerability," *Proceeding of 13<sup>th</sup> World Conference on Earthquake Engineering*, Paper no: 1721, Vancouver, BC, Canada
- Chaudhri,S.R., and Villaverde,R., (2008), "Effect of Building Nonlinearity on Seismic Response of Nonstructural Components: A Parametric Study," *Journal of Structural Engineering*, Vol.134, No.4, pp 661-670
- Chaudhuri,S.R., and Hucthinson,T.C., (2011), "Effect of Nonlinearity of Frame Buildings on Peak Horizontal Floor Acceleration," *Journal of Earthquake Engineering*, Vol.15, pp 124-142
- Chen,Y., and Soong,T.T., (1988), "State-of-the-art Review Seismic Response of Secondary Systems," *Engineering Structures*, Vol.10, pp 218-228
- Dowell,R.K., Smith,J.W., and Hutchinson,T.C., (2008), "Floor and Attached Component Seismic Amplification Factors from Nonlinear Time-History Analysis," *Proceeding of 14<sup>th</sup> World Conference on Earthquake Engineering*, Beijing, China
- EERI, (1997), *Annotated Slide Set*, Earthquake Engineering Research Institute, Oakland, CA, USA, CD ROM
- Eurocode 8 (DD-ENV 1998-1-2), (1996), *Design Provisions for Earthquake Resistance of Structures-Part 1-2: General Rules for Buildings*, European Committee for Standardisation, Brussels
- FEMA 274, (1997), *NEHRP Commentary on the Guidelines for the Seismic Rehabilitation of Buildings*, Washington, DC, USA
- FEMA 369, (2001), *NEHRP Recommended Provisions for Seismic Regulations for New Buildings and Other Structures: Part 2-Commentary*, Building Seismic Safety Council, National Institute of Building Sciences, Washington, DC, USA
- FEMA 396, (2003), *Incremental Seismic Rehabilitation of Hospital Buildings Providing Protection to People and Buildings*, Washington, DC, USA
- FEMA 412, (2002), *Installing Seismic Restraints for Mechanical Equipment, Vibration Isolation and Seismic Control* Manufacturers Association, Washington, DC, USA

- FEMA 413, (2004), *Installing Seismic Restraints for Electrical Equipment*, Vibration Isolation and Seismic Control Manufacturers Association, Washington, DC, USA
- FEMA 414, (2004), *Installing Seismic Restraints for Duct and Pipe*, Vibration Isolation and Seismic Control Manufacturers Association, Washington, DC, USA
- FEMA 454, (2006), *Designing for Earthquakes; A Manual for Architects*, Washington, DC, USA
- FEMA 460, (2005), *Seismic Considerations for Steel Storage Racks Located in Areas Accessible to the Public*, NEHRP, Washington, DC, USA
- FEMA 461, (2007), *Interim Testing Protocols for Determining the Seismic Performance Characteristics of Structural and Nonstructural Components*, Washington, DC, USA
- FEMA 577, (2007), *Design Guide for Improving Hospital Safety in Earthquakes, Floods and High Winds*, Washington, DC, USA
- FEMA E-74, (2011), *Reducing the Risks of Nonstructural Earthquake Damage: A Practical Guide*, ATC, CA, USA, USA
- Freeman,S.A., (1998), " Design Criteria For Nonstructural Component based on Tri-Services Manuals," *Proceedings of Seminar on Seismic Design, Retrofit, and Performance of Non-structural Components*, ATC-29-1, CA, USA
- Gates,W.E., and McGavin,G., (1998), "Lessons Learned from the 1994 Northridge Earthquake on Vulnerability of Non-structural Systems," *Proceedings of Seminar on Seismic Design, Retrofit, and Performance of Non-structural Components*, ATC-29-1, CA, USA
- Gillengerten,J.D., (2003), "Design of Nonstructural Systems and Components," *The Seismic Design Handbook* (Naeim,F., Editor), Kluwer Academic Publishers, Second Edition
- GHI-GHS-SR (2009), *Reducing Earthquake Risk in Hospitals from Equipment, Contents, Architectural Elements and Building Utility Systems*, GHI, GHS and Swiss Re
- Hirakawa,N., and Kanda,J., (1997), "Estimation of Failure Costs at Various Damage States," *Summaries of Technical Papers of Annual Meeting of Architectural Institute of Japan*, Vol.B-1, Kanto, 1997, pp.75-76
- Hogan,S.J., (1989), "On the dynamics of rigid-block motion under harmonic forcing," *Proceedings of Royal Society*, London, Vol.A425, pp 441-476
- Horne,P.J., and Burton,H., (2003), "Investigation of Code Seismic Force Levels for Hospital Equipments," *Proceedings of Seminar on Seismic Design, Retrofit, and Performance of Non-structural Components*, ATC-29-2, CA, USA
- Housner,G.W., (1963), "The behaviour of inverted pendulum structures during earthquakes," *Bulletin of Seismological Society of America*, Vol.53, pp 404-17
- IBC, (2000), *International Building Code*, International Code Council, Inc., Washington, DC, USA
- IBC, (2003), *International Building Code*, International Code Council, Inc., Washington, DC, USA
- IBC, (2006), *International Building Code*, International Code Council, Inc., Washington, DC, USA
- IBC, (2009), *International Building Code*, International Code Council, Inc., Washington, DC, USA
- ICC-ES AC 156, (2007), "Acceptance Criteria for Seismic Qualification by Shake-Table Testing of Nonstructural Components and Systems," International Code Council Evaluation Services, Whittier, CA, USA
- IS:1554 (Part 1), (1988), *Specification for PVC Insulated (heavy Duty) Electric Cables*, Bureau of Indian Standards, New Delhi
- IS:1893 (Part 1), (2007), *Criteria for Earthquake Resistant Design of Structures*, Bureau of Indian Standards, New Delhi
- IS:1905, (1987), *Code of Practice for Structural Use of Unreinforced Masonry*, Bureau of Indian Standards, New Delhi
- IS:2713, (1980), *Street Light Poles*, Bureau of Indian Standards, New Delhi
- IITK-GDMA, (2005), *IITK-GSDMA Guidelines for Proposed Draft Code and Commentary on Indian Seismic Code IS:1893 (Part 1)*, IITK-GSDMA-EQ05-V4.0, August 2005, Indian Institute of Technology Kanpur and Gujarat State Disaster Mitigation Authority, Gandhinagar, India
- Kasai,K., Jeng,V., and Maison,B.F., (1990), "The Significant Effects of Pounding-Induced Accelerations on Building Appurtenances," *Proceedings of Seminar on Seismic Design, Retrofit, and Performance of Nonstructural Components*, ATC-29, CA, USA
- Kehoe,B.E., and Freeman,S.A, (1998), "A Critique of Procedures for Calculating Seismic Design Forces for Nonstructural Elements," *Proceedings of Seminar on Seismic Design, Retrofit, and Performance of Non-structural Components*, ATC-29-1, CA, USA
- Kingston,K.M., (2004), "An Evaluation of Floor Response Spectra for Acceleration Sensitive Nonstructural Components Supported on Regular Frame Structure," *MS Thesis*, University of Maryland, College Park
- Kircher,C.A., (2003), "It makes Dollars and Sense to Improve Non-structural System Performance," *Proceedings of Seminar on Seismic Design, Retrofit, and Performance of Non-structural Components*, ATC-29-2, CA, USA



- Kumari,R., and Gupta,V.K., (2007), "Modal Combination Rule of Peak Floor Acceleration in Multi-storeyed Buildings," *ISET Journal of Earthquake Technology*, Vol.44, No.1, pp213-231
- Loyd,R.J., (2003), "Case Studies of Anchorage Failures," *Proceedings of Seminar on Seismic Design, Retrofit, and Performance of Non-structural Components*, ATC-29-2, CA, USA
- Makris,N., (1997), "Rigidity-plasticity-viscosity: Can electro-rheological dampers protect base-isolated structures from near-source ground motions?," *Journal of Earthquake Engineering and Structural Dynamics*, Vol.26, pp 571-91
- Makris,N., and Roussos,Y., (1998), "Rocking response and overturning of equipment under horizontal pulse-type motions," Report. PEER-98/05, *Pacific Earthquake Engineering Research Center*, University of CA, USA
- Marsantyo,R., Shimazu,T., and Araki,H., (2000), "Dynamic Response of Non-structural Systems Mounted on Floors of Buildings," *Proceedings of 12<sup>th</sup> World Conference on Earthquake Engineering*, Paper No.1872, Auckland, New Zealand
- Medina,R.A., Sankaranarayanan,R., and Kingston,K.M., (2006), "Floor response spectra for light components mounted on regular moment-resisting frame structures," *Engineering Structures*, Vol.28, pp 1927-1940
- Meyer,J.D., Soong,T.T., and Hill., R.H., (1998), "Retrofit Seismic Mitigation of Mainframe Computers and Associated Equipment: A Case Study," *Proceedings of Seminar on Seismic Design, Retrofit, and Performance of Non-structural Components*, ATC-29-1, CA, USA
- Milne,J., (1885), "Seismic experiments," *Transactions of the Seismological Society of Japan*, Vol.8, pp 1-82
- Miranda,E., and Taghavi,S., (2005), "Approximate Floor Acceleration Demands in Multistory Buildings. I: Formulation," *Journal of Structural Engineering*, Vol.131, No.2, pp 203-211
- Mondal,G., and Jain,S.K., (2005), "Design of non-structural elements for buildings: A review of Codal Provisions," *The Indian Concrete Journal*, Vol.79, No.8, pp 22-28
- \_\_\_\_\_, Northridge Earthquake Reconnaissance Team, (1995), "Northridge Earthquake of January 17,1994," *Earthquake Spectra Supplement to Volume C*, Vol.1, pp454-513
- Naeim,F., and Lobo,R., (1998), "Performance of Non-structural Components during the January 17, 1994 Northridge Earthquake - Case Studies of Six Instrumented Multistory Buildings," *Proceedings of Seminar on Seismic Design, Retrofit, and Performance of Non-structural Components*, ATC-29-1, CA, USA
- NBCC, (1995), National Building Code of Canada, Associate Committee on the National Building Code, National Research Council of Canada, Ottawa, Ontario, Canada
- NZ 1170.5 (Part 5), (2004), *Structural Design Actions, Part 5: Earthquake Actions - New Zealand*, Standards Association of New Zealand, Wellington, New Zealand
- Pekan,G., Itani,A., and Staehlin,W., (2003), "Nonstructural System Response to Vertical Excitation and Implications for Seismic Design and Qualification," *Proceedings of Seminar on Seismic Design, Retrofit, and Performance of Non-structural Components*, ATC-29-2, CA, USA
- Perkins,J.B., and Wyatt,G.E., (1990), "Hazardous Material Problems Associated with Non-structural Design in Recent California Earthquake," *Proceedings of Seminar on Seismic Design, Retrofit, and Performance of Non-structural Components*, ATC-29, CA, USA
- Porush,A.R., (1990), "An Overview of Current Building Code Seismic Requirements for Nonstructural Elements," *Proceedings of Seminar on Seismic Design, Retrofit, and Performance of Nonstructural Components*, ATC-29, CA, USA
- Reitherman,R., (1990), "Gaps between Non-structural Building Code and Standards Provisions, Design and Construction Practices, and Safety Regulations," *Proceedings of Seminar on Seismic Design, Retrofit, and Performance of Non-structural Components*, ATC-29, CA, USA
- Rodriguez,M.E., Restrepo,J.I., and Carr,A.J., (2002), "Earthquake-induced Floor Horizontal Accelerations in Buildings," *Earthquake Engineering and Structural Dynamics*, Vol.31, pp 693-718
- Roth,C., (1999), "Logic Tree Analysis of Secondary Nonstructural Systems with Independent Components," *Earthquake Spectra*, Vol.15, No.3, pp385-395
- Selvaduray,G., (1998), "Earthquake Caused Hazardous Materials Incidents at Educational Facilities," *Proceedings of Seminar on Seismic Design, Retrofit, and Performance of Non-structural Components*, ATC-29-1, CA, USA
- Singh,M.P., Moreschi,L.M., and Suarez.,L.M., (1998), "Simplified Methods For Calculating Seismic Forces For Nonstructural Components," *Proceedings of Seminar on Seismic Design, Retrofit, and Performance of Non-structural Components*, ATC-29-1, CA, USA
- Singh,M.P., Moreschi,L.M., Suarez.,L.M., and Matheu,E.E., (2006), "Seismic Design of Forces. I: Rigid Nonstructural Components," *Journal of Structural Engineering*, Vol.132, No.10, pp 1524-1532
- Singh,M.P., Moreschi,L.M., Suarez.,L.M., and Matheu,E.E., (2006), "Seismic Design of Forces. II: Flexible Nonstructural Components," *Journal of Structural Engineering*, Vol.132, No.10, pp 1533-1542
- Spanos,P.D., and Koh,A.S., (1984), "Rocking of rigid blocks due to harmonic shaking," *Journal of Engineering Mechanics*, American Society of Civil Engineers, Vol.110, pp 1627-42

- Scawthorn,C., Swan,S.W., Hamburger,R.O., and Hom,S., (1990), "Building Life-Safety Systems and Post-Earthquake Reliability, Overview of Codes and Current Practices," *Proceedings of Seminar on Seismic Design, Retrofit, and Performance of Non-structural Components*, ATC-29, CA, USA
- Taghavi,S., and Miranda,E., (2002), "Seismic Performance and Loss Assessment of Nonstructural Building Components," *Proceedings of 7th National Conference on Earthquake Engineering*, Boston, MA
- Taghavi,S., and Miranda,E., (2005), "Approximate Floor Acceleration Demands in Multistory Buildings. II: Applications," *Journal of Structural Engineering*, Vol.131, No.2, pp 212-220
- Takahashi,N., and Shiohara,H., (2004), "Life cycle Economic Loss due Seismic Damage of Nonstructural Elements," *Proceeding of 13<sup>th</sup> World Conference on Earthquake Engineering*, Paper No.203, Vancouver, BC, Canada
- Tung,A.T.Y., and Kiremidjian,A.S., (1990), "Probabilistic Performance Analysis of Elevated Liquid Storage Vessels," *Proceedings of Seminar on Seismic Design, Retrofit, and Performance of Nonstructural Components*, ATC-29, CA, USA
- UBC, (1937), *Uniform Building Code*, Pacific Coast Building Officials Conference, Los Angeles
- UBC, (1961), *Uniform Building Code*, International Conference of Building Officials, Whittier, CA, USA
- UBC, (1976), *Uniform Building Code*, International Conference of Building Officials, Whittier, CA, USA
- UBC, (1988), *Uniform Building Code*, International Conference of Building Officials, Whittier, CA, USA
- UBC, (1994), *Uniform Building Code*, International Conference of Building Officials, Whittier, CA, USA
- UBC, (1997), *Uniform Building Code*, International Conference of Building Officials, Whittier, CA, USA
- USNRC, (1978), "Regulatory Guide," Revision 1.122, Office of Standards Development, Washington, DC, USA
- Villaverde,R., (1998), "Simplified Approach to Account for Nonlinear Effects in Seismic Analysis of Nonstructural Components," *Proceedings of Seminar on Seismic Design, Retrofit, and Performance of Non-structural Components*, ATC-29-1, CA, USA
- Villaverde,R., (1998), "Seismic Design of Secondary Structures: State of the Art," *Journal of Structural Engineering*, Vol.123, No.8, pp 1011-1019
- Villaverde,R., (2009), *Fundamental Concepts of Earthquake Engineering*, Taylor and Francis Group, FL, USA, pp 950
- Yim,C.K., Chopra,A.K., and Penzien,J., (1980), "Rocking response of rigid blocks to earthquakes," *Journal of Earthquake Engineering and Structural Dynamics*, Vol.8, pp 565-87

...

Appendix A  
**Examples of Some Common Non-Structural Elements**

S.No.	Classification of NSE
1	<b>Architectural Components</b>
1.1	<b>Interior Non-structural Walls and Partitions</b>
	<i>:: Plain Un-reinforced Masonry Wall</i>



*:: All other walls and partitions*





1.2 Cantilever Elements

:: Parapets and cantilever interior non-structural walls





:: Chimneys



1.3 Exterior Non-structural Walls

:: Wall Element



1.4 Veneer

:: Low Deformability and attachment - Adhered Veneer







1.5 | Ceilings







1.6 Cabinets







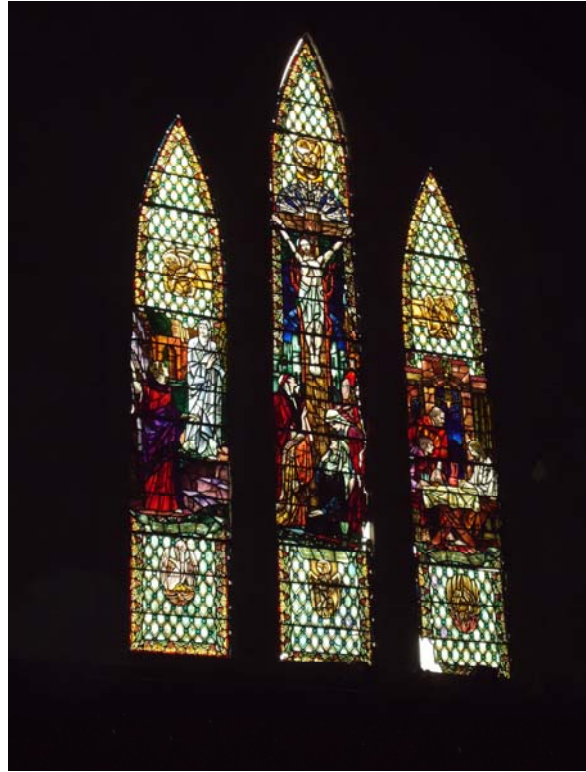




1.7 Appendages and Ornamentations











1.8 Rigid Components





1.9

**Flexible Components**

*:: High deformability elements and attachments*





2.0

**Mechanical and Electrical Component/Element**

2.1

**General Mechanical**

*:: General*





2.2 Piping Systems











:: Mounted in-line with ductwork



2.4 DTH Dish Antennae on rooftops



2.5 Electrical Control Panel





2.6 Electrical Lighting Fixtures





...



## Examples of Design Calculations for Select Non-Structural Elements

### B.1 GENERAL

This appendix presents examples of design calculations related to *force-sensitive NSEs* and *displacement-sensitive NSEs*, as discussed in the preceding chapters of this book. In all these examples, the calculations shown are related to *forces* for which the connections between NSEs and adjoining SEs have to be designed, and to *displacements* which should be accommodated at the interface between the NSEs and the adjoining SEs. Three examples are considered of *force-sensitive NSEs*, namely,

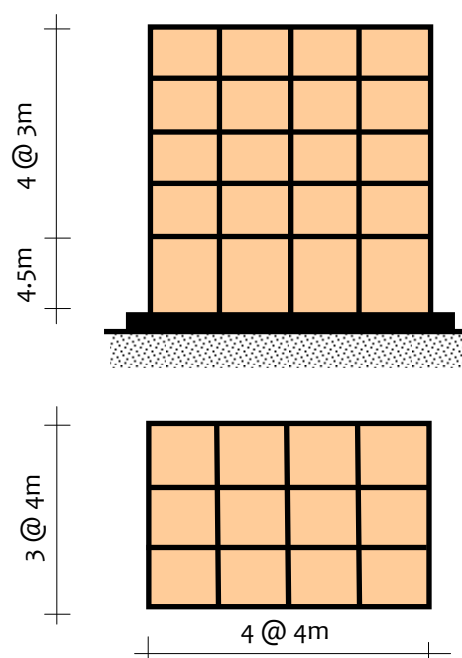
- (1) NSEs anchored only to Horizontal SEs,
- (2) NSEs anchored only to Vertical SEs, and
- (3) NSEs anchored to both Horizontal and Vertical SEs,

as given in Section 2.2.1, and three of *displacement-sensitive NSEs*

- (1) NSEs supported on two SEs on the same building, but at different elevations,
- (2) NSEs supported on two SEs that shake independently, and
- (3) NSEs supported on a SE on building and the ground,

as given in Section 2.2.2. Here, connection force and displacement demands are estimated as per provisions of the IITK-GSDMA Guidelines [IITK-GSDMA, 2005].

Realistic conditions are considered in the examples of NSEs with reference to a benchmark building (Figure B.1) in high seismic region. Except when otherwise stated, the benchmark building is a 5-storey unreinforced masonry infilled RC frame building with four bays in X-direction in plan and three in Y-direction; bay width is 4m in each direction. The height of a typical storey is 3m and that of the ground storey 4.5m, with foundation being 1.5m below ground level. Columns are considered hinged at the top of the foundation. Sizes of columns are 400×400 mm and of beams 300×400 mm, and thickness of floor slabs 150 mm. Grade of concrete is M25. In these examples, only the bare frame is considered and URM infills not modeled in the building; in practice, all stiffnesses of SEs should be included. Also, the building and all SEs are considered to behave elastically.



**Figure B.1:** Benchmark Building: It is a 5-storey RC moment frame building; only bare frame is considered

## B.2 FORCE-SENSITIVE NSEs

### B.2.1 NSEs anchored only to Horizontal SEs

Consider earthquake safety of a water storage tank (Figure B.2) placed atop the 5-storey RC frame benchmark building. The tank is made of high density plastic, and has capacity to hold 5,000L of water. Its diameter is 2m and height 2m. The mass of the empty tank is 100 kg. When the ground shakes during earthquakes, three possibilities arise, namely: (1) the tank can slide horizontally, (2) the tank can rock and eventually topple, or (3) the tank can slide as well as rock (and topple). To secure it against earthquake effects, the tank should be fastened to the roof slab. Here, effect of sloshing is *not* considered of water in partly filled tank under dynamic earthquake shaking condition.

The design of fasteners between the tank and the roof slab is governed by the design lateral force  $F_p$  given by Eq.(5.3). Considering that the building is located in Seismic Zone V in India, the Seismic Zone Factor  $Z$  is 0.36 (Table 5.7).  $(x/h)$  is 1.0, since the height  $x$  of point of attachment of the tank above top of the foundation of the building is the same as the overall height  $h$  of the building. The Component Amplification Factor  $a_p$  is 1.0 (Table 5.9) for a water tank, and the Component Response Modification Factor  $R_p$  is 1.5 (Table 5.9). Further, the Importance Factor  $I_p$  is 1.0 (Table 5.8). Thus,

$$F_p = \frac{0.36}{2} \left( 1 + \frac{16.5}{16.5} \right) \frac{1}{1.5} \times 1.0 \times (5100 \times 9.8) = 0.24 \times 49,980 = 11,995 \text{ N}$$

The overturning moment at the base of the tank is due to  $F_p$  acting at a height of  $h/2$  from the base of the tank, and the restoring moment due to tank weight  $W_p$ . Clearly,

$$F_p \frac{h}{2} - W_p \frac{\phi}{2} = 0.24 W_p \times \frac{1.25}{2} - W_p \times \frac{2.0}{2} = -0.85 W_p$$

Thus, no overturning is expected to occur; no bolt is required to prevent overturning, but it may topple if the force is higher. Also, bolts are required to prevent sliding of the tank.

If the coefficient of friction is 0.3, the lateral frictional resistance force is  $(0.3 \times 5100 \times 9.8) = 14,996$  N. Thus, the demand is 11,995 N and the resistance is more than that. Thus, sliding is not likely to occur. In any case, friction is not to be relied on in the safety of systems during earthquake shaking, because vertical accelerations induced on the RC slabs can render the frictional resistance ineffective. Thus, positive systems are required to resist the lateral force and secure the water tank from sliding. For resisting a lateral force of 11,995N, four bolts of 12mm are considered. The design lateral shear carrying capacity of the four bolts available (as per Clause 8.4 of IS:800-2007) is

$$V_n = 4 \times \left( A_v \frac{f_y}{\sqrt{3}} \right) \frac{1}{\gamma_{m0}} = 4 \times \left( \pi \times \frac{12^2}{4} \right) \times \frac{250}{\sqrt{3}} \times \frac{1}{1.1} = 59,362 \text{ N} ,$$

and, the design lateral force demand calculated (as per Clause 8.4 of IS:800-2007) is

$$V_d = \gamma_f V = 1.5 \times 11,995 = 17,993 \text{ kN} .$$

Thus, demand is less than the supply and hence, four MS bolts of 12mm diameter are sufficient to prevent the tank from sliding.

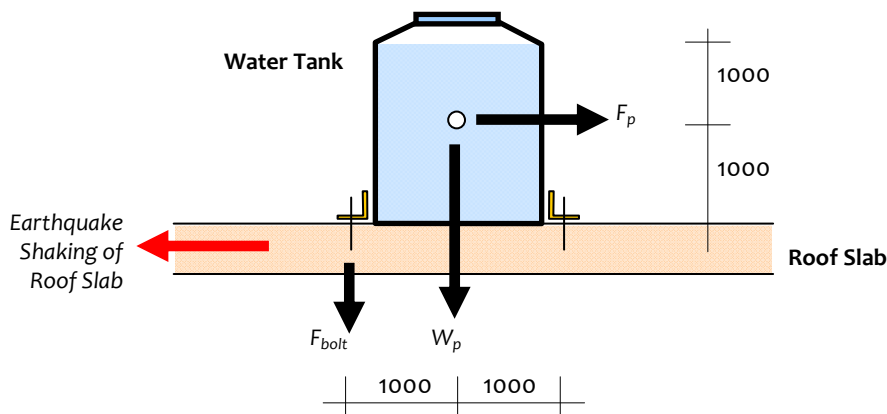


Figure B.2: Anchored water tank on roof top: Forces acting on it during earthquake shaking



### B.2.2 NSEs anchored only to Vertical SEs

Consider earthquake safety of a cupboard (Figure B.3) placed on the fifth storey of the 5-storey RC frame benchmark building. The cupboard, including its contents, has a mass of 2,000 kg. It is 0.9m long, 0.45m wide and 2.1m tall. When the ground shakes during earthquakes, (1) the cupboard can topple laterally outwards from the wall if simply rested on the floor slab without any anchorage to the adjoining masonry wall, or (2) the cupboard can cause collapse of the masonry wall in the out-of-plane direction. To secure it against earthquake effects, the cupboard should be fastened to the wall and the out-of-plane safety of the wall should be ensured during strong ground shaking.

The design of the fastener between the cupboard and the wall is governed by the design lateral force  $F_p$  given by Eq.(5.3). Considering that the building is located in Seismic Zone V in India, the Seismic Zone Factor  $Z$  is 0.36 (Table 5.7). Since the point of attachment of the cupboard is on the floor level in the fifth storey,  $x=13.5\text{m}$  and  $h=16.5\text{m}$ . The Component Amplification Factor  $a_p$  is 1.0 (Table 5.9) for a shelf fastened to the vertical wall, and the Component Response Modification Factor  $R_p$  is 1.5 (Table 5.9). Further, the Importance Factor  $I_p$  is 1.0 (Table 5.8). Thus,

$$F_p = \frac{0.36}{2} \left( 1 + \frac{13.5}{16.5} \right) \frac{1.0}{1.5} \times 1.0 \times (2,000 \times 9.8) = 0.216 \times 19,600 = 4,234\text{N}$$

The overturning moment at the base of the cupboard is due to  $F_p$  acting at its mid-height and the restoring moment due to its weight  $W_p$ . Clearly,

$$F_p \frac{h}{2} - W_p \frac{b}{2} = 0.216W_p \times \frac{1.05}{2} - W_p \times \frac{0.45}{2} = -0.112W_p$$

Thus, the cupboard is not likely to topple under the design lateral force. Also, it is necessary to ensure that the cupboard will not slide under the same lateral force.

Consider two 6mm diameter MS bolts for resisting a lateral force of 4,234N. The axial load safety of each 6mm diameter MS bolts is estimated using the Indian Steel Code IS:800-2007 and the Draft Indian Masonry Code IS:1905-2006. Firstly, the design axial tension is calculated using a Partial Safety Factors  $\gamma_t$  for loads of 1.5 for dead load and 1.5 for earthquake load, as per Clause 5.3.3 of IS:800-2007. Hence, the design axial tension to be carried is  $(1.5 \times 4,234 =)$  6,351 kN. In calculating the design tensile capacity of each bolt, there are two items, namely design strength from rupture and from yielding. The design strength  $T_{dg}$  due to yielding of the gross section of one bolt (as per Clause 6.2) is given by:

$$T_{dg} = \left( \frac{f_y}{\gamma_{m0}} \right) A_g = \left( \frac{250}{1.1} \right) \times \pi \times \left( \frac{6.0}{2} \right)^2 = 12,852\text{ N},$$

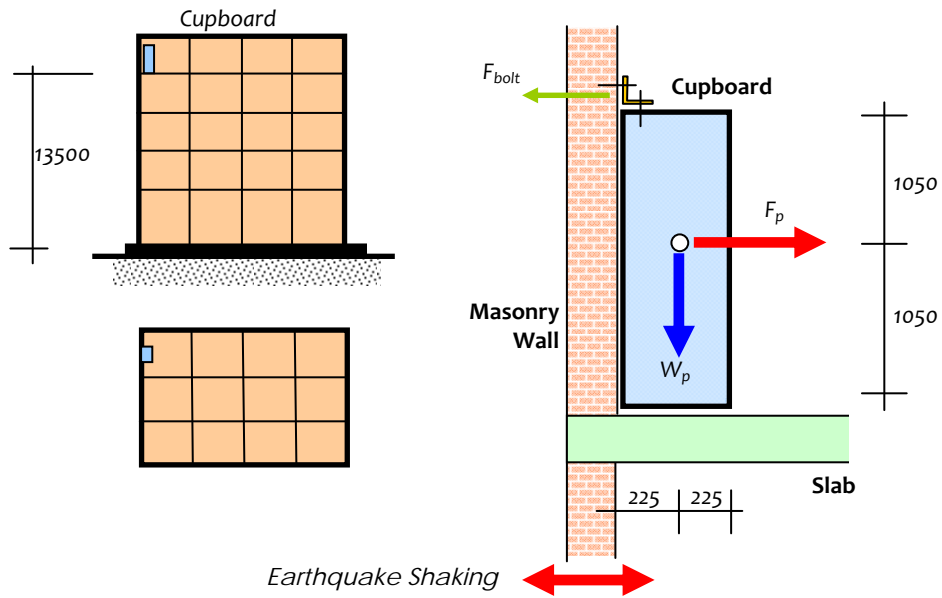
and, design strength  $T_{dn}$  due to rupture of critical section of one bolt (as per Clause 6.3) is given by

$$T_{dn} = \left( \frac{f_u}{\gamma_{m1}} \right) 0.9A_n = \left( \frac{400}{1.25} \right) \times 0.9 \times \pi \times \left( \frac{6.0}{2} \right)^2 = 16,286\text{ N},$$

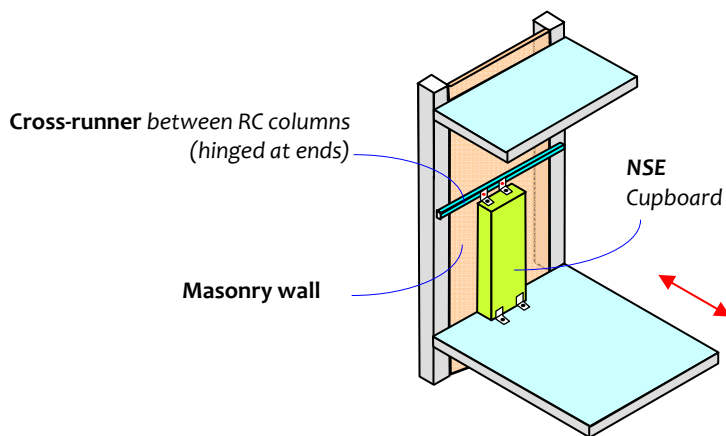
Thus, for the two bolts on top of the shelf, the design capacity corresponds to the smaller of the two capacities (as per Clause 6.1) and is

$$T_d = 2 \times 12,852 = 25,704\text{ N}.$$

Since, this is more than the demand of 6,351N, the two 6mm diameter bolts are capable of carrying the tension and prevent sliding of the cupboard. Additionally, it is required to check to ensure that the top bolts holding the shelf should not fail in bond off the *unreinforced masonry wall*. If it is not capable of resisting this out-of-plane action, a new mitigation measure is required.



**Figure B.4:** Cupboard adjacent to masonry wall: forces acting on it during earthquake shaking



**Figure B.5:** Alternate mitigation measure to prevent out-of-plane collapse of cupboard and masonry wall: cupboard is connected to a cross-runner held between RC columns

### B.2.3 NSEs anchored to both Horizontal and Vertical SEs

Consider earthquake safety of a large storage rack (Figure B.5) placed on the ground storey of the 5-storey RC frame benchmark building. Its height exceeds that of the first storey and hence, the RC slab is removed in the building at the floor above the first storey. The storage rack including its contents has a mass of 10,000 kg. It is 2.3m long, 0.8m wide and 4.8m tall. When the ground shakes during earthquakes, the storage rack can topple laterally in its out-of-plane direction (*i.e.*, along the 0.8 width direction) outwards from the wall, if simply rested on the floor slab without any anchorage to the adjoining structural system. To secure it against strong earthquake ground shaking effects, the storage rack should be fastened to structural system of the building with positive anchorage systems.

The design of the fastener between the storage rack and the structural system of the building is governed by the design lateral force  $F_p$  given by Eq.(5.3). Considering that the building is located in Seismic Zone V in India, the Seismic Zone Factor  $Z$  is 0.36 (Table 5.7). Since the point of attachment of the storage rack is 1.5m above the top of the foundation level, in the ground storey area,  $x=1.5\text{m}$  and  $h=16.5\text{m}$ . The Component Amplification Factor  $a_p$  is 1.0 (Table 5.9) for a shelf fastened to the vertical wall, and the Component Response Modification Factor  $R_p$  is 2.5 (Table 5.9). Further, the Importance Factor  $I_p$  is 1.5 (Table 5.8). Thus,

$$F_p = \frac{0.36}{2} \left( 1 + \frac{1.5}{16.5} \right) \frac{1.0}{2.5} \times 1.5 \times (10,000 \times 9.8) = 0.118 \times 98,000 = 11,564\text{N}$$

The overturning moment at the base of the storage rack is due to  $F_p$  acting at its mid-height and the restoring moment due to its weight  $W_p$ . Clearly,

$$F_p \frac{h}{2} - W_p \frac{b}{2} = 0.118W_p \times \frac{4.8}{2} - W_p \times \frac{0.8}{2} = -0.117W_p.$$

Thus, the storage rack is not likely to topple under the design lateral force. Also, it is necessary to ensure that the storage rack will not slide under the same lateral force.

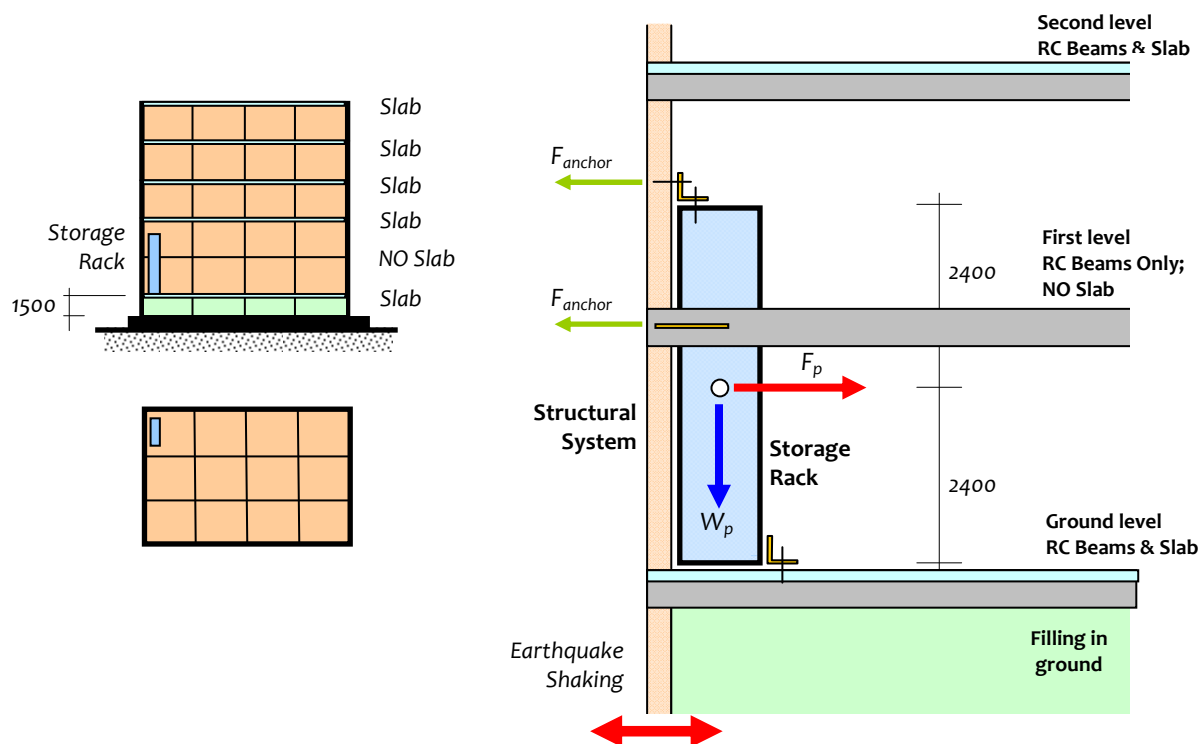


Figure B.5: Storage Rack adjacent to structural systems: forces acting on it during earthquake shaking

Consider two 12mm diameter MS bolts each at the top and beam level of the rack for resisting a lateral force of 11,564N. The axial load safety of each 12mm diameter MS bolt is estimated using the Indian Steel Code IS:800-2007. Firstly, the design axial tension is calculated using a Partial Safety Factors  $\gamma_t$  for loads of 1.5 for dead load and 1.5 for earthquake load, as per Clause 5.3.3 of IS:800-2007. Hence, the design axial tension to be carried is  $(1.5 \times 11,564 =)$  17,346 kN. In calculating the design tensile capacity of each bolt, there are two items, namely design strength from rupture and from yielding. The design strength  $T_{dg}$  due to yielding of the gross section of one bolt (as per Clause 6.2) is given by:

$$T_{dg} = \left( \frac{f_y}{\gamma_{m0}} \right) A_g = \left( \frac{250}{1.1} \right) \times \pi \times \left( \frac{12.0}{2} \right)^2 = 25,704 \text{ N},$$

and, the design strength  $T_{dn}$  due to rupture of the critical section of one screw (as per Clause 6.3) is given by

$$T_{dn} = \left( \frac{f_u}{\gamma_{m1}} \right) 0.9 A_n = \left( \frac{400}{1.25} \right) \times 0.9 \times \pi \times \left( \frac{12.0}{2} \right)^2 = 32,572 \text{ N},$$

Thus, for the four bolts at the top level of the storage rack, the design capacity corresponds to the smaller of the two capacities (as per Clause 6.1) and is

$$T_d = 4 \times 25,704 = 102,816 \text{ N}$$

Since, this is more than the demand of 17,346N, the four 12mm diameter screws are capable of carrying the tension and prevent sliding of the storage rack.

### B.3 DISPLACEMENT-SENSITIVE NSEs

#### B.3.1 NSEs having Relative Displacement with respect to Ground

Consider earthquake safety of a continuous mild steel pipe carrying water or gas from a tank outside the 5-storey RC frame benchmark building (resting directly on ground at a distance away from the building) to services inside the building (resting on the slab over the first storey of the building) (Figure B.6). The pipe is of 300mm diameter with 4mm wall thickness; the length of the pipe is 6m from the support on the building to that on ground. The pipe is rigidly connected to both the ground and the building, both of which are shaking back and forth during strong earthquake shaking of the ground. The pipe can be pulled and compressed during this action of its two supports owing to the relative deformation between them. To secure it against strong earthquake ground shaking effects, the water and gas pipes should be checked against the imposed relative displacements between their ends.

The pipe is attached at a height of  $(1500+3000\text{mm}=)$  4,500mm from the top of the foundation. The design displacement is imposed between the ends of the pipe, when the design earthquake imposes on the floor slab above the first storey to move horizontally from its initial position under the design lateral forces. This movement is independent of the other support of the pipe which is shaken directly by the vibrating ground. For the benchmark building considered, from Eqs.(5.4) and (5.5), the relative displacement  $\delta$  between the first slab level at 4.5m (*i.e.*,  $h_x=4.5\text{m}$ ) and the top of the foundation of the column (*i.e.*,  $h_y=0$ ) is taken from linear structural analysis of the benchmark building-pipe system; this value is 8.8 mm. Here, the other support is expected to move the same amount at the top of the foundation of the columns. Therefore, the relative deformation between the top of the foundation and that at the first floor level is taken as the relative deformation between the ends of the pipe. Hence,  $D_p$  is given by  $R$  times  $\delta$ . For the benchmark building,  $R$  is 5.0, and therefore

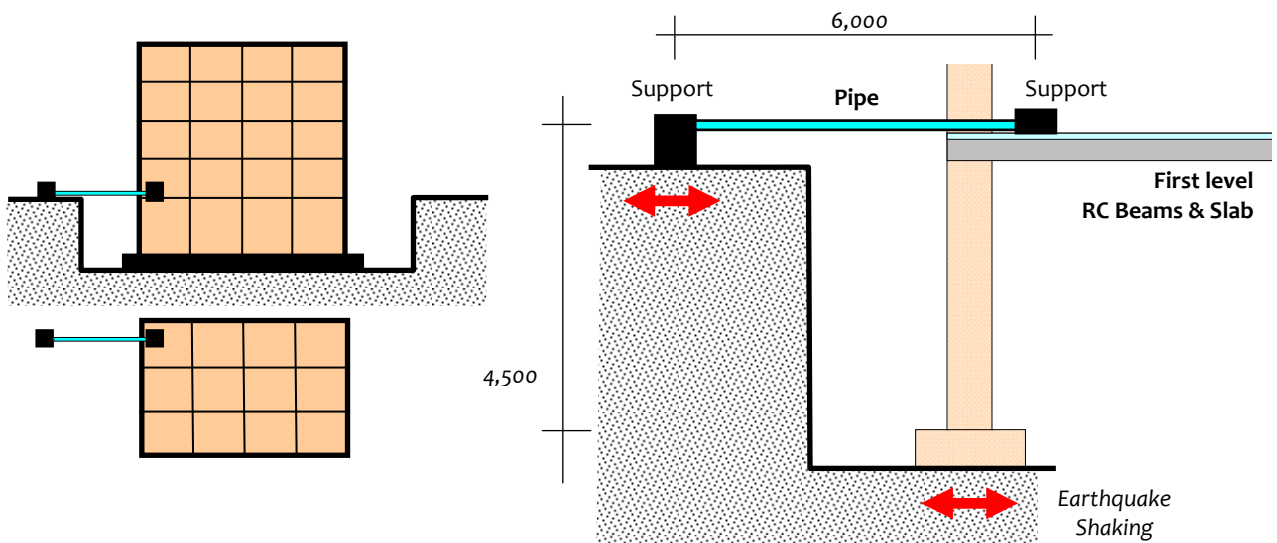
$$D_p = 5 \times 8.8 = 43\text{mm}.$$

From Eq.(5.5), the maximum allowable relative displacement  $\Delta_{max}$  is given by

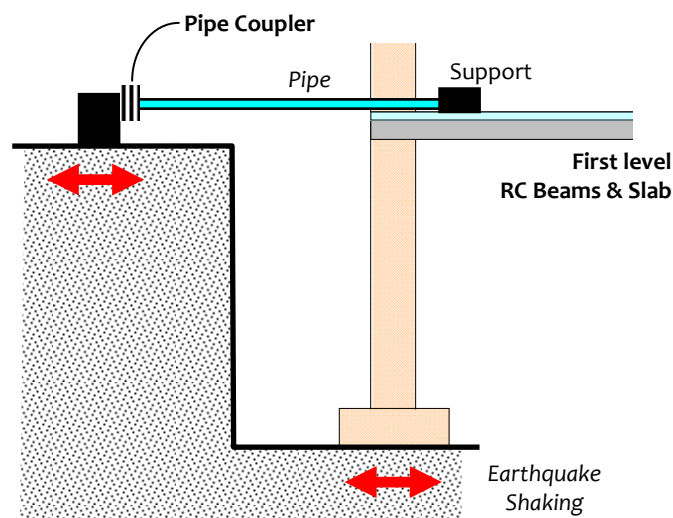
$$\Delta_{max} = 5 \times (4500 \times 0.04 - 0) = 90mm$$

corresponding to the upper limit of 0.4% drift under *design* lateral forces specified in Clause 7.12.1 of Draft IS:1893 (Part 1) - 2007. The pipe should be able to resist an axial tension and compression corresponding to the axial displacement of 43mm calculated above, if the pipe is fixed as assumed at its two ends. If not, mitigation measure is required.

In general, it is not possible to accurately estimate the relative displacement between the ends of the pipe, because the actual hazard is not quantifiable precisely. Also, when the diameter of the pipe is large, even a small axial deformation can cause large stresses in the pipe, owing to higher stiffness of large pipes. Hence, it is prudent to not *defy* the earthquake shaking, but to *comply* with it. Thus, adequate slack is required to be provided at one end of the pipe corresponding to the expected relative deformation between the ends (Figure B.7). A device that facilitates this is called a *flexible coupler*; it is like the bellows of an accordion.



**Figure B.6:** Water Mains, Fire Hydrant Supply Pipes and Gas Pipes connected to the building from the outside: shaking of the two supports of the pipe imposes relative displacements at its end



**Figure B.7:** Water Mains, Fire Hydrant Supply Pipes and Gas Pipes connected to building from the outside: mitigation measure of using a pipe coupler to allow for flexibility along the length of the pipe

### B.3.2 NSEs having Inter-storey Relative Displacement

Consider earthquake safety of a single-piece window glass that spans the full space between the beam-column frame in the 5-storey RC frame benchmark building at the fifth storey (Figure B.8). The glass panel is of size 3500mm×2600mm and of 6mm thickness. The glass panel is snugly held between beams and columns of the building, both of which are shaking back and forth during strong earthquake shaking of the ground. Hence, the glass panel is subjected to distortions imposed by the adjoining beams and columns. This can be mitigated by providing flexible packing between the glass and the adjoining frame. To ensure that the glass is secured against strong earthquake ground shaking effects, the glass panel should be checked against the imposed relative displacements between its edges and for the sufficiency of the dimension of the flexible packing.

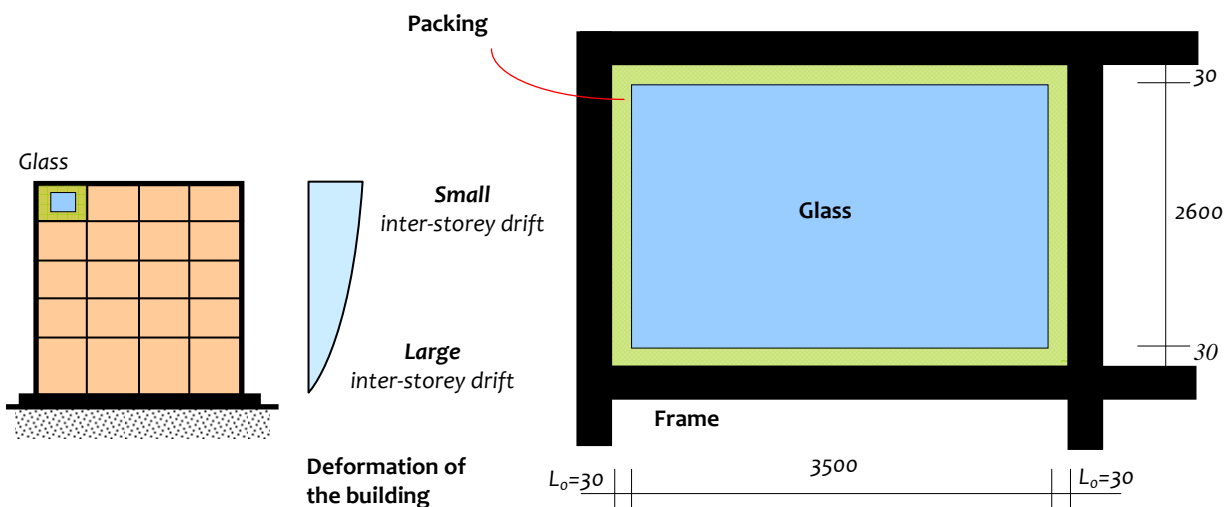
In Eq.(5.4), design lateral displacements above and below the fifth storey are obtained as 20.58 mm and 19.63 mm from structural analysis of the benchmark building under the design lateral forces. Thus, from Eq.(5.4),

$$D_p = 5 \times (20.58 - 19.63) = 4.75 \text{ mm} .$$

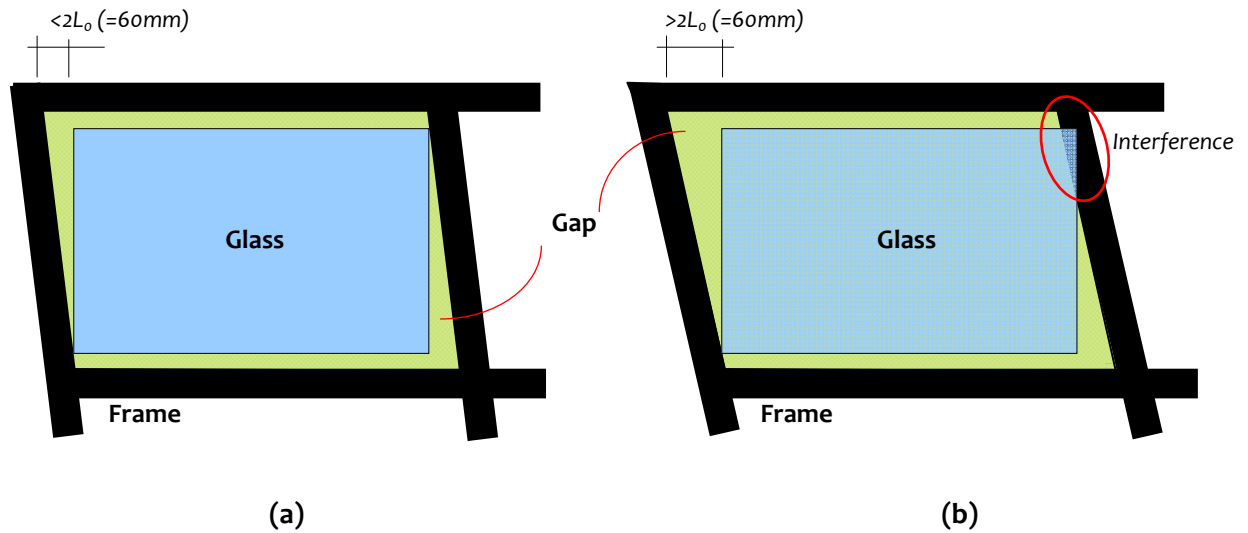
In Eq.(5.5),  $R$  is 5,  $h_x$  16.5m,  $h_y$  13.5m, and  $\Delta_{aA}/h_{sx}$  0.004. Hence, the maximum allowable relative displacement  $\Delta_{max}$  is

$$\Delta_{max} = 5 \times (16500 - 13500) \times 0.04 = 60 \text{ mm} .$$

Since  $D_p = 4.74 \text{ mm}$  is less than  $\Delta_{max} = 60 \text{ mm}$ ,  $D_p$  will govern. Since the gap  $L_0$  provided is 30mm between the frame columns and glass panel on each side, the laterally deforming frame columns will not touch the glass until the lateral deformation reaches 60mm. After this, the columns will foul with the glass panel (Figure B.9). Hence, the glass panel is safe in the fifth storey. It is important to perform similar checks to ensure the safety of such glass panels in all storeys, especially when the drift in the other storeys is larger.



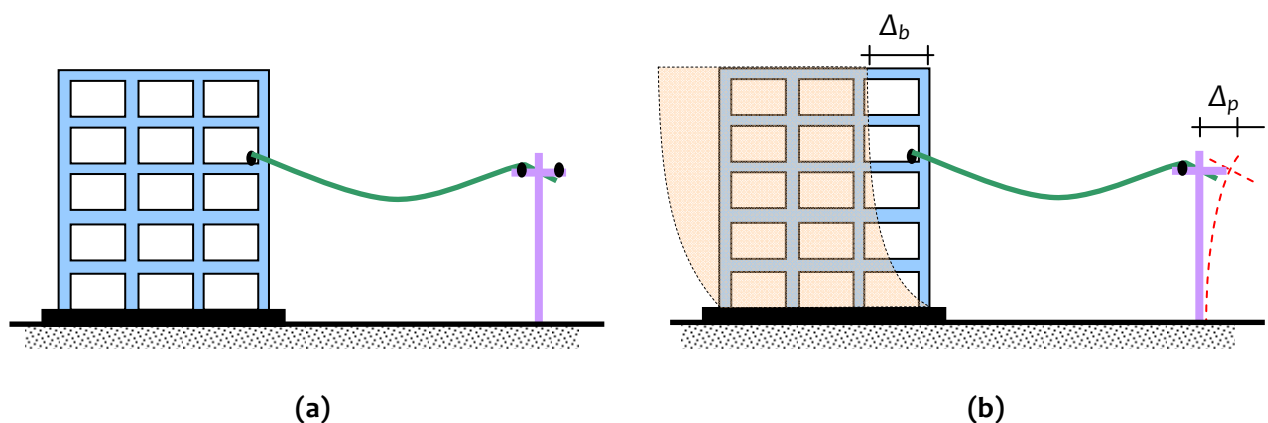
**Figure B.8:** Single-piece Window Glass: flexible packing is provided all around between the building frame and glass panel



**Figure B.9:** Deformed Building Frame and un-deformed Window Glass: (a) limiting distortion governed by the packing width available between the two, i.e., 60mm, and (b) lateral deformation of frame more than 60mm play available

### B.3.3 NSEs having Relative Displacement between Two Items Shaking Independently

In many instances, electric power lines are brought to a building directly from an electric power supply pole adjoining building (Figure B.10). The electric cable is supported at one end on the pole and at the other on the building; it is possible that the power line is received at any elevation of the building, depending on the field conditions of safety. During strong earthquake shaking, both the building as well as the electric pole oscillates. Hence, the electric wire can get loose and sag more, or get taut and straighten out, depending on whether the building is shaking towards the electrical pole or away from it. In the latter case, if the movement of the building away from the pole is large (Figure B.11b), it is possible that the electric wire is stretched in tension to the extent that it snaps. This can result in loss of electricity supply to the building, and if the cable drops down to the ground, may lead to electrocution of people on ground. Relevant calculations are presented to ensure that cables do not stretch in tension and break during the expected earthquake shaking at the location of the building.



**Figure B.10:** Cable wire connected between building and pole: (a) Initial position, and (b) Extreme position of building and pole causing maximum tension in cable

The relative lateral displacement between the pole and the building will determine whether or not the electric wire will break. Conversely, the electric wire should be designed to accommodate the relative displacement  $D_p$  between its supports during strong earthquake shaking, as calculated by Eq.(5.4).  $D_p$  shall be obtained by

$$\Delta L = \Delta_b + \Delta_p, \tag{B.1}$$

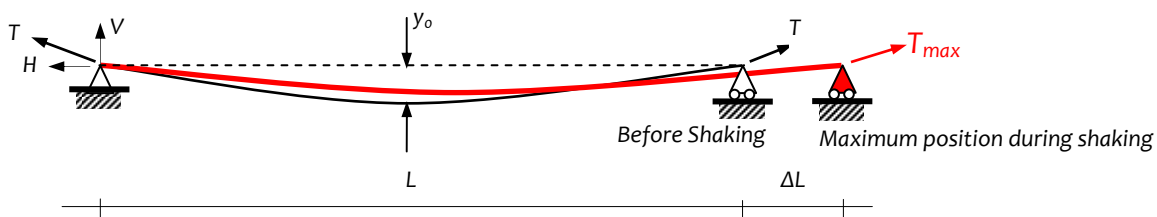
where  $\Delta_b = R\delta_b$  and  $\Delta_p = \delta_p$ , in which  $\delta_b$  and  $\delta_p$  are design lateral displacements of the building and the pole obtained as below.

Before earthquake shaking, let the two supports (*i.e.*, the building and the pole) holding the electric cable be at a horizontal distance  $L$ , the sag in the cable  $y_0$ , and the tension in the cable  $T$  (Figure B.11). During earthquake shaking, let the supports suffer a maximum relative lateral displacement  $\Delta L$  when the two supports move away from each other. Let the maximum tension be  $T_{max}$  generated in the cable in the stretched position during the expected design earthquake shaking. The exercise is to design the cable (*i.e.*, determine the area  $A$  of cross-section and initial sag  $y_0$  or tension  $T_0$ ) such that the cable does not break in physical tension created by the pull during the expected design earthquake shaking.

The lateral displacement  $\Delta_b$  of the benchmark building is estimated as per Eq.(B.1) using  $R=5$  and the design lateral displacement  $\delta$  obtained from structural analysis of the building under the action of the design floor lateral loads; this displacement is measured at the point on the building where the cable is connected from the electric pole. Hence,

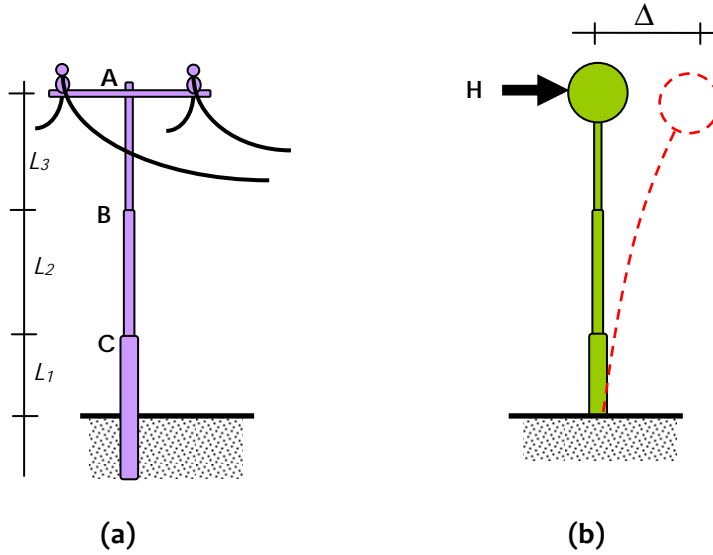
$$\Delta_b = 5\delta. \tag{B.2}$$

The electric pole can be simplified as a mass attached to a cantilever having cross-section properties  $L$  and  $I$  and material property  $E$ . Consider a pole made of non-prismatic sections (Figure B.12), say in three steps of lengths  $L_1, L_2$  and  $L_3$ , with cross-section properties  $I_1, I_2$  and  $I_3$ , respectively.



**Figure B.11:** Cable wire connected between building and pole: Tension, sag and extreme positions of cable before and during earthquake





**Figure B.12:** Electric pole: (a) schematic, and (b) its idealisation with deformed shape under lateral earthquake shaking

The lateral stiffness  $k$  of this pole subjected to concentrated lateral force  $H$  at the top is

$$k = \frac{H}{\Delta_A} = \frac{1}{X_B + R_B L_3 + \frac{L_3^3}{3EI_3}}, \quad (\text{B.3})$$

where

$$X_B = X_C + R_C L_2 + \frac{L_2^3}{3EI_2} + \frac{L_3 L_2^2}{2EI_2}, \text{ and } R_B = R_C + \frac{L_2^2}{2EI_2} + \frac{L_3 L_2}{EI_2},$$

in which

$$X_C = \frac{L_1^3}{3EI_1} + \frac{(L_2 + L_3)L_1^2}{2EI_1}, \text{ and } R_C = \frac{L_1^2}{2EI_1} + \frac{(L_2 + L_3)L_1}{EI_1}.$$

The equivalent static *Design Lateral Force*  $V_B$  applied at the tip of the pole is a modified version of Eq.(5.3), namely

$$V_B = \frac{ZI}{2} \left( \frac{S_a}{g} \right) W, \quad (\text{B.4})$$

In Eq.(B.4), the Response Reduction Factor  $R$  is dropped in comparison to Eq.(5.3), because the pole does not have any redundancy and is expected to remain elastic at the end of the earthquake. In Eq.(B.4) for calculation of  $S_a/g$ , Natural Period  $T$  of the pole is calculated in the direction of shaking using basic principles of mechanics, the natural period of the pole is given by

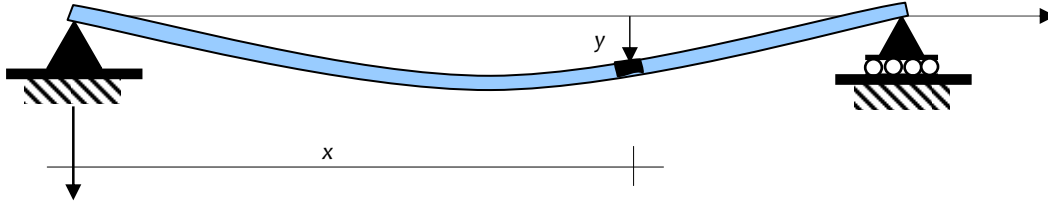
$$T = 2\pi \sqrt{\frac{m}{k}}, \quad (\text{B.5})$$

where  $m$  is the effective mass at the top of the pole and  $k$  is lateral stiffness of the pole given by Eq.(B.3). Hence, the displacement  $\Delta_p$  at the tip of the pole due to force  $V_B$  is given by

$$\Delta_p = V_B/k. \quad (\text{B.6})$$

Let the initial arc length of the cable be  $L_c$ , and weight per unit length be  $w$  of the cable of area of cross section  $A$  (Figure B.13). The relationship between the cable geometry and force is

$$y = \frac{H}{wL} \left[ \text{Cosh} \left( \frac{x}{h} \right) - 1 \right]. \quad (\text{B.7})$$



**Figure B.13:** Electric cable: The sag of the cable follows a centenary profile

Using Eq.(B.7), the arch length of the cable is

$$L_c = \frac{H}{w} \text{Sinh}\left(\frac{wL}{H}\right) L$$

$$L_c = \int_0^L \left(\frac{ds}{dx}\right) dx = \int_0^L \sqrt{1 + \left(\frac{dy}{dx}\right)^2} dx = \int_0^L \sqrt{1 + \left\{\text{Sinh}\left(\frac{wx}{H}\right)\right\}^2} dx = \int_0^L \text{Cosh}\left(\frac{wx}{H}\right) dx . \quad (\text{B.8})$$

The vertical force equilibrium from Figure B.15 suggests that vertical force  $V$  at the support is

$$V = \frac{wL_c}{2} . \quad (\text{B.9})$$

At the support (Figure B.12), the inclined tension force  $T$  is given by:

$$T = \sqrt{H^2 + V^2} , \quad (\text{B.10})$$

or

$$H = \sqrt{T^2 - V^2} . \quad (\text{B.11})$$

The following step-wise procedure may be followed to arrive at the design initial sag  $y_0$  in the cable:

(a) **Step 1:** In stretched state, assume the length of cable to be  $L + \Delta L = L^*$ , say. Using Eq.(B.9), estimate the vertical component of force at support, as

$$V^* = \frac{wL^*}{2} .$$

Tension in cable in its stretched state should be less than  $T_{max}$  to ensure no rupture in the cable.

Hence, from Eq.(B.11),

$$H = \sqrt{T_{max}^2 - V^{*2}} .$$

(b) **Step 2:** Calculate actual arc length of cable  $L_c$  using Eq.(B.11) as

$$L_c = \frac{H}{w} \text{Sinh}\left(\frac{w(L + \Delta L)}{H}\right) .$$

(c) **Step 3:** If assumed length  $L^*$  is within tolerance of calculated length  $L_c$ , i.e.,  $L_c \approx L^*$ , then go to Step 4, else assume  $L^* = L_c$  and go to Step 1.

(d) **Step 4:** Calculate sag in stretched state as

$$y_0 = \frac{T_{max}}{w} \left[ \text{Cosh}\left\{\frac{w\left(\frac{L + \Delta L}{2}\right)}{T_{max}}\right\} - 1 \right] .$$

This gives a feel of the state of the cable during earthquake.

(e) **Step 5:**  $L_c$  is known from Step 3 and  $L$  is given. Hence, solve nonlinear Eq.(B.8) and calculate  $H$ .

(f) **Step 6:** Calculate  $V$  using  $L_c$  from Eq.(B.9). Calculate  $T$ , using  $H$  and  $V$  from Eq.(B.10).

(g) Step 7: Calculate the original sag  $y_0$  required in cable using Eq.(B.7). This is helpful while installing the cable.

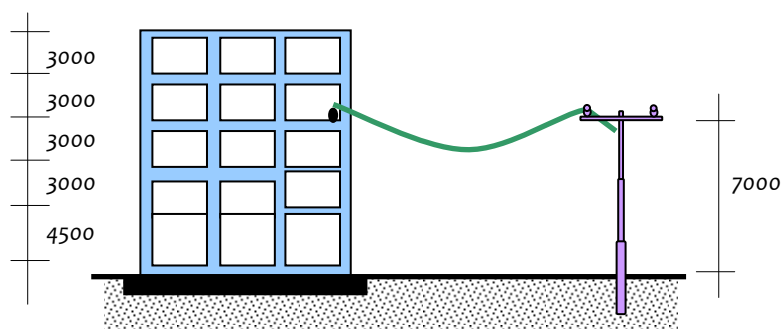
Consider power supply to the third storey of the benchmark building from a pole 10m away from the building through an electric cable (Figure B.14). The direction of the arrival of the cable to the building is along the direction in which the building has three bays. The electric pole height is 7m above the ground. It carries two copper core conductors (each of area of 35mm<sup>2</sup>) with PVC insulation to the building at the slab above the third storey. The initial length of the electric cable and its sag needs to be designed, so that it does not break in tension under lateral shaking of building and pole during the expected strong earthquake at the building site. The specifications and assumptions of the electric pole and the cable are given below:

- (i) *Pole*: A hollow mild steel tube (named 410 TP-16) is chosen as the electric pole to get an effective pole height of 7m. As per Table 1 associated with Clause 5.1 of IS:2713-1980, this pole is a three-step pole is of 8.5m height with step heights of  $L_1=4.5\text{m}$ ,  $L_2=2\text{m}$  and  $L_3=2\text{m}$ , and a planting depth of 1.5m. The outside diameters are 114.3, 88.9 and 76.1mm, with a wall thickness of 3.65mm. Hence, the effective free height above ground is 7m. The outer diameters of the pole at the three steps are,  $\phi_1=114.3\text{ mm}$ ,  $\phi_2=88.9\text{mm}$  and  $\phi_3=76.1\text{mm}$ ; the thickness of hollow tube is 3.63mm all through the height irrespective of the outer diameter. The mass of the pole is 73kg. The mass of the supplements on top of tower is assumed to be 10kg.
- (ii) *Electric Cable*: As per Clause 9.2 and 9.3 of IS:1554 (Part 1)-1988, the material (*i.e.*, copper) of the cable with conductor area of 35mm<sup>2</sup> has a mass density of 8,920 kg/m<sup>3</sup>, yield strength of 230 MPa and modulus of elasticity of 120GPa. The thickness of the PVC insulation of the conductor is chosen as 1.5 mm; the mass density of the insulation material is 1,400 kg/m<sup>3</sup>. In the calculation of the mass of the cable effective at the top of the pole, 5m is taken out of the total 10m length of the cable between the pole and the building.

The design lateral displacements are listed in Table B.2 at different storeys as obtained from structural analysis. Since the electric cable is connected to roof slab of the third storey, the building displacement  $\Delta_b$  to be used in Eq.(B.1) is taken from Table B.2 as 32mm.

**Table B.2:** Design displacements along the considered direction from structural analysis

Storey	Inter-storey Drift $\Delta_y$ (mm)
4	38
3	32
2	23
1	12



**Figure B.15:** Cable wire connected between building and cable: Geometry of building and pole

The design lateral displacement  $\Delta_p$  of the pole is calculated only for shaking along the considered direction in which the cable is oriented. The mass of half length of the cable is assumed to act with the pole during earthquake shaking. Hence,

$$\text{Mass of cable} = 0.367 \text{ kg/m} \times 5 \text{ m} = 1.8 \text{ kg}$$

$$\text{Total Mass at top of pole} = (0.5 \times 73) + 10 + 1.8 = 48.3 \text{ kg}$$

The geometric properties of the three steps of the cantilever pole are shown in Table 4 of IS:2713-1980. Considering the modulus of elasticity  $E$  of the material of the pole to be 200GPa and geometric properties as listed in Table 4, the lateral stiffness  $k$  of the pole from Eq.(B.3) is

$$k = \frac{1}{X_A} = 1.633 \text{ N/mm} .$$

Using the mass (assumed to be lumped at the top) and the lateral stiffness of the pole, the natural period  $T$  of the pole is obtained using Eq.(B.5) as

$$T = 2\pi \sqrt{\frac{48.3}{1.633}} = 1.08 \text{ s} .$$

As per Eq.(5.1),

$$\frac{S_a}{g} = 1.36$$

Hence, the design lateral force  $V_{Bp}$  on the pole from Eq.(B.4) is

$$V_{Bp} = \frac{0.36 \times 1.0}{2} (1.36) \times 0.423 = 0.35 \text{ kN}$$

Therefore, the design lateral displacement of the pole is given by Eq.(B.6) as

$$\Delta_p = \frac{348.4}{1.633} = 213.4 \approx 220 \text{ mm}$$

Hence, the design relative displacement between the ends of pole are calculated using Eq.(B.1) as

$$\Delta_p = \delta_p \approx 220 \text{ mm}$$

$$\Delta_B = R\delta_p = 5 \times 32 = 160 \text{ mm}$$

Hence, using Eq.(B.2)

$$\Delta L = 220 + 160 = 380 \text{ mm} \approx 400 \text{ mm}$$

Therefore,

$$L = 10 \text{ m, and}$$

$$L + \Delta L = L + D = 10.4 \text{ m}$$

To estimate the weight per unit length of the cable, the area of the insulation needs to be estimated. Therefore, area of insulation is  $\pi(D_{out}^2 - D_{in}^2)/4 = \pi(9.68^2 - 6.68^2)/4 = 38.54 \text{ mm}^2$ . Thus, weight  $w$  per unit length of wire is  $(A_{core}\rho_{core}g + A_{insulation}\rho_{insulation}g)$  given by

$$w = A_{core}\rho_{core}g + A_{insulation}\rho_{insulation}g = 35 \times 8.92 \times 9.8 + 38.54 \times 1.4 \times 9.8 = 3.76 \text{ N/m}$$

Assuming a factor of safety of 2 for against yielding in tension of copper cable, the design maximum tension  $T_{max}$  of the cable is

$$T_{max} = \frac{230}{2} \times 35 = 4025 \text{ N} .$$

Repeating step 1-7 mentioned in above procedure will lead to final result.

### Step 1

$$L^* = 10.4 \text{ m}$$

$$V^* = \frac{wL^*}{2} = 19.084 \text{ N}$$

### Step 2

$$H = \sqrt{T_{max}^2 - V^{*2}} = \sqrt{4025^2 - 19.084^2} = 4024.95 \text{ N}$$

$$L_c = \frac{H}{w} \sinh\left(\frac{w(L + \Delta L)}{H}\right) = \frac{4024.95}{3.67} \sinh\left(\frac{3.67(10 + 0.4)}{4024.95}\right) = 10.40015587m$$

**Step 3**

Since  $L_c \approx L^*$ ,  $L_c = 10.4m$

**Step 4**

$$y_0 = \frac{T_{\max}}{w} \left[ \cosh\left\{\frac{w\left(\frac{L + \Delta L}{2}\right)}{T_{\max}}\right\} - 1 \right] = \frac{4025}{3.67} \left[ \cosh\left\{\frac{3.67\left(\frac{10 + 0.4}{2}\right)}{4025}\right\} - 1 \right] = 12.3mm$$

**Step 5**

$$L_c = \frac{H}{w} \sinh\left(\frac{w(L + \Delta L)}{H}\right) = 10.4 = \frac{H}{3.67} \sinh\left(\frac{3.67 \times 10.4}{H}\right)$$

Solving,

$$H = 75.4N$$

**Step 6**

$$V = \frac{3.67 \times 10.4}{2} = 19.084N$$

$$T = \sqrt{H^2 + V^2} = \sqrt{75.4^2 + 19.084^2} = 77.78N$$

**Step 7**

$$y_0 = \frac{T}{w} \left[ \cosh\left\{\frac{wL}{2T}\right\} - 1 \right] = \frac{77.78}{3.67} \left[ \cosh\left\{\frac{3.67 \times 10}{2 \times 77.78}\right\} - 1 \right] = 0.6m$$

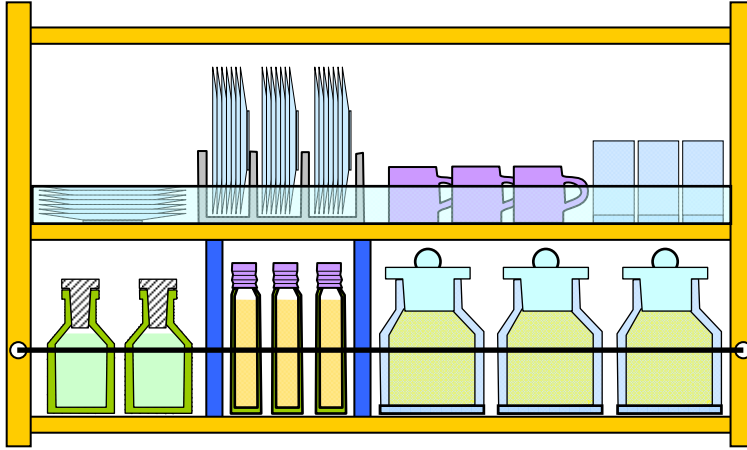
So, the length of the cable to be provided is 10.41m and the initial sag to be provided is 0.6m.

During strong ground shaking, the electric cable may get taut and sustain large relative displacement between its ends. But, if the cable sag is as per the above design, tension in the cable will not exceed  $T_{max}$ .

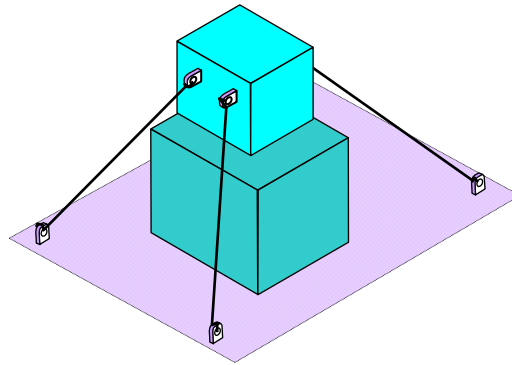
...



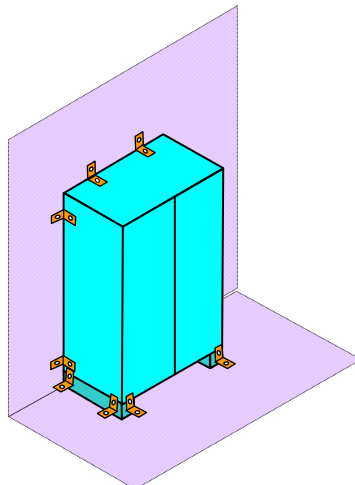




**1.** Non-engineered NSEs



**2.** Pre-engineered NSEs



**3.** Engineered NSEs