

**LOGIC FOR EVERYONE**

**Robert A. Herrmann**

Previous titled "Logic For Midshipmen"

Mathematics Department  
U. S. Naval Academy  
572C Holloway Rd.  
Annapolis, MD 21402-5002

# CONTENTS

## Chapter 1

### Introduction

1.1 Introduction . . . . .	5
----------------------------	---

## Chapter 2

### The Propositional Calculus

2.1 Constructing a Language by Computer . . . . .	9
2.2 The Propositional Language . . . . .	9
2.3 Slight Simplification, Size, Common Pairs . . . . .	13
2.4 Model Theory — Basic Semantics . . . . .	15
2.5 Valid Formula . . . . .	19
2.6 Equivalent Formula . . . . .	22
2.7 The Denial, Normal Form, Logic Circuits . . . . .	26
2.8 The Princeton Project, Valid Consequences . . . . .	32
2.9 Valid Consequences . . . . .	35
2.10 Satisfaction and Consistency . . . . .	38
2.11 Proof Theory . . . . .	42
2.12 Demonstrations, Deduction from Premises . . . . .	45
2.13 The Deduction Theorem . . . . .	47
2.14 Deducibility Relations . . . . .	50
2.15 The Completeness Theorem . . . . .	52
2.16 Consequence Operators . . . . .	54
2.17 The Compactness Theorem . . . . .	57

## Chapter 3

### Predicate Calculus

3.1 First-Order Language . . . . .	63
3.2 Free and Bound Variable Occurrences . . . . .	67
3.3 Structures . . . . .	70
3.4 Valid Formula in $Pd$ . . . . .	76
3.5 Valid Consequences and Models . . . . .	82
3.6 Formal Proof Theory . . . . .	86
3.7 Soundness and Deduction Theorem for $Pd'$ . . . . .	87
3.8 Consistency, Negation Completeness, Compactness, Infinitesimals . . . . .	91
3.9 Ultralogics and Natural Systems . . . . .	97

### Appendix

Chapter 2 . . . . .	102
Chapter 3 . . . . .	105

Answers to Some Exercises . . . . .	109
-------------------------------------	-----

Index . . . . .	123
-----------------	-----



## Chapter 1 - INTRODUCTION

### 1.1 Introduction.

The discipline known as *Mathematical Logic* will not specifically be defined within this text. Instead, you will study some of the concepts in this significant discipline by actually doing mathematical logic. Thus, you will be able to surmise for yourself what the mathematical logician is attempting to accomplish.

Consider the following three arguments taken from the disciplines of military science, biology, and set-theory, where the symbols (a), (b), (c), (d), (e) are used only to locate specific sentences.

(1) (a) If armored vehicles are used, then the battle will be won. (b) If the infantry walks to the battle field, then the enemy is warned of our presence. (c) If the enemy is warned of our presence and armored vehicles are used, then we sustain many casualties. (d) If the battle is won and we sustain many casualties, then we will not be able to advance to the next objective. (e) Consequently, if the infantry walks to the battle field and armored vehicles are used, then we will not be able to advance to the next objective.

(2) (a) If bacteria grow in culture A, then the bacteria growth is normal. (b) If an antibiotic is added to culture A, then mutations are formed. (c) If mutations are formed and bacteria grow in culture A, then the growth medium is enriched. (d) If the bacteria growth is normal and the growth medium is enriched, then there is an increase in the growth rate. (e) Thus, if an antibiotic is added to culture A and bacteria grow in culture A, then there is an increase in the growth rate.

(3) (a) If  $b \in B$ , then  $(a, b) \in A \times B$ . (b) If  $c \in C$ , then  $s \in S$ . (c) If  $s \in S$  and  $b \in B$ , then  $a \in A$ . (d) If  $(a, b) \in A \times B$  and  $a \in A$ , then  $(a, b, c, s) \in A \times B \times C \times S$ . (e) Therefore, if  $c \in C$  and  $b \in B$ , then  $(a, b, c, s) \in A \times B \times C \times S$ .

With respect to the three cases above, the statements that appear before the words “Consequently, Thus, Therefore” need not be assumed to be “true in reality.” The actual logical pattern being presented is not, as yet, relative to the concept of what is “true in reality.” How can we analyze the logic behind each of these arguments? First, notice that each of the above arguments employs a technical language peculiar to the specific subject under discussion. This technical language should not affect the logic of each argument. The logic is something “pure” in character which should be independent of such phrases as  $a \in A$ . Consequently, we could substitute abstract symbols – symbols that carry no meaning and have no internal structure – for each of the phrases such as the one “we will not be able to advance to the next objective.” Let us utilize the symbols P, Q, R, S, T, H as replacements for these phrases with their technical terms.

Let P = *armored vehicles are used*, Q = *the battle will be won*, R = *the infantry walks to the battle field*, S = *the enemy is warned of our presence*, H = *we sustain many casualties*, T = *we will not be able to advance to the next objective*. Now the words *Consequently*, *Thus*, *Therefore* are replaced by the symbol  $\vdash$ , where the  $\vdash$  represents the processes the human mind (brain) goes through to “logically arrive at the statement” that follows these words.

Mathematics, in its most fundamental form, is based upon human experience and what we do next is related totally to such an experience. You must intuitively know your left from your right, you must intuitively know what it means to “move from the left to the right,” you must know what it means to “substitute” one thing for another, and you must intuitively know one alphabet letter from another although different individuals may write them in slightly different forms. Thus P is the same as  $P$ , etc. Now each of the above sentences contains the words *If* and *then*. These two words are not used when we analyze the above three logical arguments they will intuitively be understood. They will be part of the symbol  $\rightarrow$ . Any time you have a statement such as “If P, then Q” this will be symbolized as  $P \rightarrow Q$ . There is one other important word in these statements. This word is *and*. We symbolize this word *and* by the symbol  $\wedge$ . What do these three arguments look like when we translate them into these defined symbols? Well, in the next display, I’ve used the “comma” to separated the sentences and parentheses to remove any possible misunderstandings that might occur. When the substitutions are made in argument (1) and we write the sentences (a), (b), (c), (d), (e) from left to right, the logical argument looks like

$$P \rightarrow Q, R \rightarrow S, (S \wedge P) \rightarrow H, (Q \wedge H) \rightarrow T \vdash (R \wedge P) \rightarrow T. \quad (1)'$$

Now suppose that you use the same symbols  $P, Q, R, S, H, T$  for the phrases in the sentence (a), (b), (c), (d), (e) (taken in the same order from left to right) for arguments (2), (3). Then these next two arguments would look like

$$P \rightarrow Q, R \rightarrow S, (S \wedge P) \rightarrow H, (Q \wedge H) \rightarrow T \vdash (R \wedge P) \rightarrow T. \quad (2)'$$

$$P \rightarrow Q, R \rightarrow S, (S \wedge P) \rightarrow H, (Q \wedge H) \rightarrow T \vdash (R \wedge P) \rightarrow T. \quad (3)'$$

Now, from human experience, compare these three patterns (i.e. compare them as if they are geometric configurations written left to right). It is obvious, is it not, that they are the “same.” What this means for us is that the logic behind the three arguments (1), (2), (3) appears to be the same logic. All we need to do is to analyze one of the patterns such as (1)' in order to understand the process more fully. For example, is the logical argument represented by (1)' correct?

One of the most important basic questions is how can we mathematically analyze such a logical pattern when we must use a language for the mathematical discussion as well as some type of logic for the analysis? Doesn't this yield a certain type of *double think* or an obvious paradox? This will certainly be the case if we don't proceed very carefully. In 1904, David Hilbert gave the following solution to this problem which we re-phrase in terms of the modern computer. A part of Hilbert's method can be put into the following form.

The abstract language involving the symbols  $P, Q, R, S, T, H, \vdash, \wedge, \rightarrow$  are part of the computer language for a “logic computer.” The manner in which these symbols are combined together to form correct logical arguments can be checked or verified by a fixed computer program. However, outside of the computer we use a language to write, discuss and use mathematics to construct, study and analyze the computer programs before they are entered into various files. Also, we analyze the actual computer operations and construction using the same outside language. Further, we don't specifically explain the human logic that is used to do all of this analysis and construction. Of course, the symbols  $P, Q, R, S, T, H, \vdash, \wedge, \rightarrow$  are a small part of the language we use. What we have is two languages. The language the computer understands and the much more complex and very large language — in this case English — that is employed to analyze and discuss the computer, its programs, its operations and the like. Thus, we do our mathematical analysis of the logic computer in what is called a *metalanguage* (in this case English) and we use the simplest possible human logic called the *metallogic* which we don't formally state. Moreover, we use the simplest and most convincing mathematical procedures — procedures that we call *metamathematics*. These procedures are those that have the largest amount of empirical evidence that they are consistent. In the literature the term *meta* is sometimes replaced by the term *observer*. Using this compartmentizing procedure for the languages, one compartment the computer language and another compartment a larger metalanguage outside of the computer, is what prevents the mathematical study of logic from being “circular” or a “double think” in character. I mention that the metallogic is composed of a set of logical procedures that are so basic in character that they are universally held as correct. We use simple principles to investigate some highly complex logical concepts in a step-b-step effective manner.

It's clear that in order to analyze mathematically human deductive procedures a certain philosophical stance must be taken. We must believe that the mathematics employed is itself correct logically and, indeed, that it is powerful enough to analyze all significant concepts associated with the discipline known as “Logic.” The major reason we accept this philosophical stance is that the mathematical methods employed have applications to thousands of areas completely different from one another. If the mathematical methods utilized are somehow in error, then these errors would have appeared in all of the thousands of other areas of application. Fortunately, mathematicians attempt, as best as they can, to remove all possible error from their work since they are aware of the fact that their research findings will be used by many thousands of individuals who accept these finding as absolutely correct logically.

It's the facts expressed above that leads one to believe that the carefully selected mathematical procedures used by the mathematical logician are as absolutely correct as can be rendered by the human mind. Relative to the above arguments, is it important that they be logically correct? The argument as stated in biological terms is an actual experimental scenario conducted at the University of Maryland Medical School, from 1950 – 51, by Dr. Ernest C. Herrmann, this author's brother. I actually aided, as a teenager, with the basic mathematical aspects for this experiment. It was shown that the continued use of an antibiotic not only produced resistant mutations but the antibiotic was also an enriched growth medium for such mutations. Their rate of growth increased with continued use of the same antibiotic. This led to a change in medical

procedures, at that time, where combinations of antibiotics were used to counter this fact and the saving of many more lives. But, the successful conclusion of this experiment actually led to a much more significant result some years later when my brother discovered the first useful anti-viral agent. The significance of this discovery is obvious and, moreover, with this discovery began the entire scientific discipline that studies and produces anti-viral drugs and agents.

From 1979 through 1994, your author worked on one problem and two questions as they were presented to him by John Wheeler, the Joseph Henry Professor of Theoretical Physics at Princeton University. These are suppose to be the “greatest problem and questions on the books of physics.” The first problem is called the *General Grand Unification Problem*. This means to develop some sort of theory that will unify, under a few theoretical properties, all of the scientific theories for the behavior of all of the Natural systems that comprise our universe. Then the two other questions are “How did our universe come into being?” and “Of what is empty space composed?” As research progressed, findings were announced in various scientific journals. The first announcement appeared in 1981 in the *Abstracts of papers presented before the American Mathematical Society*, 2(6), #83T-26-280, p. 527. Six more announcements were made in this journal, the last one being in 1986, 7(2),# 86T-85-41, p. 238, entitled “A solution of the grand unification problem.” Other important papers were published discussing the methods and results obtained. One of these was published in 1983, “Mathematical philosophy and developmental processes,” *Nature and System*, 5(1/2), pp. 17-36. Another one was the 1988 paper, “Physics is legislated by a cosmogony,” *Speculations in Science and Technology*, 11(1), pp. 17-24. There have been other publications using some of the procedures that were developed to solve this problem and answer the two questions. The last paper, which contained the entire solution and almost all of the actual mathematics, was presented before the Mathematical Association of America, on 12 Nov., 1994, at Western Maryland College.

Although there are numerous applications of the methods presented within this text to the sciences, it is shown in section 3.9 that there exists an elementary *ultrallogic* as well as an *ultraword*. The properties associated with these two entities should give you a strong indication as to how the above discussed theoretical problem has been solved and how the two physical questions have been answered.

## NOTES



## Chapter 2 - THE PROPOSITIONAL CALCULUS

### 2.1 Constructing a Language By Computer.

Suppose that you are given the symbols  $P$ ,  $Q$ ,  $\wedge$ , and left parenthesis  $($ , right parenthesis  $)$ . You want to start with the set  $L_0 = \{P, Q\}$  and construct the complete set of different (i.e. not geometrically congruent in the plane) strings of symbols  $L_1$  that can be formed by putting the  $\wedge$  between two of the symbols from the set  $L_0$ , **with repetitions allowed**, and putting the  $($  on the left and the  $)$  on the right of the construction. *Also you must include the previous set  $L_0$  as a subset of  $L_1$ .* I hope you see easily that the complete set formed from these (metalanguage) rules would be

$$L_1 = \{P, Q, (P \wedge P), (Q \wedge Q), (P \wedge Q), (Q \wedge P)\} \quad (2.1.1)$$

Now suppose that you start with  $L_1$  and follow the same set of rules and construct the complete set of symbol strings  $L_2$ . This would give

$$\begin{aligned} L_2 = \{ & P, Q, (P \wedge P), (P \wedge Q), (P \wedge (P \wedge P)), (P \wedge (P \wedge Q)), (P \wedge (Q \wedge P)), \\ & (P \wedge (Q \wedge Q)), (Q \wedge P), (Q \wedge Q), (Q \wedge (P \wedge P)), (Q \wedge (P \wedge Q)), (Q \wedge (Q \wedge P)), \\ & (Q \wedge (Q \wedge Q)), ((P \wedge P) \wedge P), ((P \wedge P) \wedge Q), ((P \wedge P) \wedge (P \wedge P)), ((P \wedge P) \wedge (P \wedge Q)), \\ & ((P \wedge P) \wedge (Q \wedge P)), ((P \wedge P) \wedge (Q \wedge Q)), ((P \wedge Q) \wedge P), ((P \wedge Q) \wedge Q), \\ & ((P \wedge Q) \wedge (P \wedge P)), ((P \wedge Q) \wedge (P \wedge Q)), ((P \wedge Q) \wedge (Q \wedge P)), \\ & ((P \wedge Q) \wedge (Q \wedge Q)), ((Q \wedge P) \wedge P), ((Q \wedge P) \wedge Q), \\ & ((Q \wedge P) \wedge (P \wedge P)), ((Q \wedge P) \wedge (P \wedge Q)), ((Q \wedge P) \wedge (Q \wedge P)), \\ & ((Q \wedge P) \wedge (Q \wedge Q)), ((Q \wedge Q) \wedge P), ((Q \wedge Q) \wedge Q), \\ & ((Q \wedge Q) \wedge (P \wedge P)), ((Q \wedge Q) \wedge (P \wedge Q)), \\ & ((Q \wedge Q) \wedge (Q \wedge P)), ((Q \wedge Q) \wedge (Q \wedge Q))\}. \end{aligned} \quad (2.1.2)$$

Now I did not form the, *level two*,  $L_2$  by guess. I wrote a simple computer program that displayed this result. If I now follow the same instructions and form level three,  $L_3$ , I would print out a set that takes four pages of small print to express. But you have the intuitive idea, the metalanguage rules, as to what you would do if you had the previous level, say  $L_3$ , and wanted to find the strings of symbols that appear in  $L_4$ . But, the computer would have a little difficulty in printing out the set of all different strings of symbols or what are called *formulas*, (these are also called well-defined formula by many authors and, in that case, the name is abbreviated by the symbol *wffs*). Why? Since there are 2,090,918 different formula in  $L_4$ . Indeed, the computer could not produce even internally all of the formulas in level nine,  $L_9$ , since there are more than  $2.56 \times 10^{78}$  different symbol strings in this set. This number is greater than the estimated number of atoms in the observable universe. But you will soon able to show that  $(((((P \wedge Q) \wedge (Q \wedge Q)))))) \in L_9$  ( $\in$  means *member of*) and this formula is not a member of any other level that comes before  $L_9$ . You'll also be able to show that  $((P \wedge Q) \wedge (P \wedge Q))$  is not a formula at all. But all that is still to come.

In the next section, we begin a serious study of formula, where we can investigate properties associated with these symbol strings on any level of construction and strings that contain many more *atoms*, these are the symbols in  $L_0$ , and many more *connectives*, these are symbols like  $\wedge$ ,  $\rightarrow$  and more to come.

### 2.2 The Propositional Language.

There are many things done in mathematical logic that are a mathematical formalization of obvious and intuitive things such as the above construction of new symbol strings from old symbol strings. **The intuitive concept comes first and then the formalization comes after this.** In many cases, I am going to put the actual accepted mathematical formalization in the appendix. If you have a background in mathematics, then you can consult the appendix for the formal mathematical definition. As I define things, I will indicate that the deeper stuff appears in the appendix by writing (see appendix).

We need a way to talk about formula in general. That is we need symbols that act like *formula variables*. This means that these symbols represent any formula in our formal language, with or without additional restrictions such as the level  $L_n$  in which they are members.

---

**Definition 2.2.1.** Throughout this text, the symbols  $A, B, C, D, E, F$  (letters at the front of the alphabet) will denote formula variables.

---

In all that follows, we use the following *interpretation metasymbol*, “[ ]:” I’ll show you the meaning of this by example. The symbol will be presented in the following manner.

[A]: . . . . .

There will be stuff written where the dots . . . . . are placed. Now what you do is the substitute for the formula  $A$ , in ever place that it appears, the stuff that appears where the . . . . . are located. For example, suppose that

[A]: it rained all day, [ $\wedge$ ]: and

Then for formula  $A \wedge A$ , the interpretation [ $A \wedge A$ ]: would read

it rained all day and it rained all day

You could then adjust this so that it corresponds to the correct English format. This gives

It rained all day and it rained all day.

Although it is not necessary that we use all of the following *logical connectives*, using them makes it much easier to deal with ordinary everyday logical arguments.

---

**Definition 2.2.2.** The following is the list of basic *logical connectives* with their technical names.

- |                             |                                       |
|-----------------------------|---------------------------------------|
| (i) $\neg$ (Negation)       | (iv) $\rightarrow$ (The conditional)  |
| (ii) $\wedge$ (Conjunction) | (v) $\leftrightarrow$ (Biconditional) |
| (iii) $\vee$ (Disjunction)  |                                       |
- 

REMARK: Many of the symbols in Definition 2.2.2 carry other names throughout the literature and even other symbols are used.

To construct a formal language from the above logical connectives, you consider (ii), (iii), (iv), (v) as *binary* connectives, where this means that some formula is placed immediately to the left of each of them and some formula is placed immediately to the right. BUT, the symbol  $\neg$  is special. It is called an *unary* connective and formulas are formed as follows: your write down  $\neg$  and place a formula immediately to the right and only the right of  $\neg$ . Hence if  $A$  is a formula, then  $\neg A$  is also a formula.

---

**Definition 2.2.3.** The construction of the propositional language  $L$  (see appendix).

(1) Let  $P, Q, R, S, P_1, Q_1, R_1, S_1, P_2, Q_2, R_2, S_2, \dots$  be an infinite set of starting formula called the set of *atoms*.

(2) Now, as our starting level, take any nonempty subset of these atoms, and call it  $L_0$ .

(3) You construct, in a step-by-step manner, the next level  $L_1$ . You first consider as members of  $L_1$  all the elements of  $L_0$ . Then for each and every member  $A$  in  $L_0$  (i.e.  $A \in L_0$ ) you add ( $\neg A$ ) to  $L_1$ . Next you take each and every pair of members  $A, B$  from  $L_0$  **where repetition is allowed** (this means that  $B$  could be the same as  $A$ ), and add the new formulas ( $A \wedge B$ ), ( $A \vee B$ ), ( $A \rightarrow B$ ), ( $A \leftrightarrow B$ ). The result of this construction is the set of formula  $L_1$ . Notice that in  $L_1$  every formula except for an atom has a left parenthesis ( and a right parenthesis ) attached to it. These parentheses are called *extralogical symbols*.

(4) Now repeat the construction using  $L_1$  in place of  $L_0$  and you get  $L_2$ .

(5) This construction now continues step-by-step so that for any natural number  $n$  you have a level  $L_n$  constructed from the previous level and level  $L_n$  contains the previous levels.

(6) Finally, a formula  $F$  is a member of the propositional language  $L$  if and only if there is some natural number  $n \geq 0$  such that  $F \in L_n$ .

---

**Example 2.2.1** The following are examples of formula and the particular level  $L_i$  indicated is the first level in which they appear. Remember that  $\in$  means “a member or element of”.

$P \in L_0$ ; ( $\neg P$ )  $\in L_1$ ; ( $P \wedge (Q \rightarrow R)$ )  $\in L_2$ ; ( $(P \wedge Q) \wedge R$ )  $\in L_2$ ; ( $P \wedge (Q \wedge R)$ )  $\in L_2$ ; ( $(P \rightarrow Q) \vee (Q \rightarrow S)$ )  $\in L_2$ ; ( $P \rightarrow (Q \rightarrow (R \rightarrow S_2))$ )  $\in L_3$ .

**Example 2.2.2** The following are examples of strings of symbols that are NOT in  $L$ .

$(P)$ ;  $((P \rightarrow Q)$ ;  $\neg(P)$ ;  $()Q$ ;  $(P \rightarrow (Q))$ ;  $(P = (Q \rightarrow S))$ .

Unfortunately, some more terms must be defined so that we can communicate successfully. Let  $A \in L$ . The  $\text{size}(A)$  is the smallest  $n \geq 0$  such that  $A \in L_n$ . Note that if  $\text{size}(A) = n$ , then  $A \in L_m$  for each level  $m$  such that  $m \geq n$ . And, of course,  $A \notin L_k$  for all  $k$ , if any, such that  $0 \leq k < n$ . ( $\notin$  is read “not a member of”). Please note what symbols are metasyms and that they are not symbols within the formal language  $L$ .

There does not necessary exist a unique interpretation of the above formula in terms of English language expressions. There is a very basic interpretation, but there are others that experience indicates are logically equivalent to the basic interpretations. The symbol  $\mathbb{N}$  means the set  $\{0, 1, 2, 3, 4, 5, \dots\}$  of natural numbers including zero.

---

**Definition 2.2.4** The basic English language interpretations.

- (i)  $\lceil \neg \rceil$ : not, (it is not the case that).
- (ii)  $\lceil \wedge \rceil$ : and
- (iii)  $\lceil \vee \rceil$ : or
- (iv) For any  $A \in L_0$ ,  $\lceil A \rceil$ : a simple declarative sentence, a sentence which contains no interpreted logical connectives OR a set of English language symbols that is NOT considered as decomposed into distinct parts.
- (v) For any  $n \in \mathbb{N}$ ,  $A, B \in L_n$ ;  $\lceil A \vee B \rceil$ :  $\lceil A \rceil$  or  $\lceil B \rceil$ .
- (vi) For any  $n \in \mathbb{N}$ ,  $A, B \in L_n$ ;  $\lceil A \wedge B \rceil$ :  $\lceil A \rceil$  and  $\lceil B \rceil$ .
- (vii) For any  $n \in \mathbb{N}$ ,  $A, B \in L_n$ ;  $\lceil A \rightarrow B \rceil$ : if  $\lceil A \rceil$ , then  $\lceil B \rceil$ .
- (viii) For any  $n \in \mathbb{N}$ ,  $A, B \in L_n$ ;  $\lceil A \leftrightarrow B \rceil$ :  $\lceil A \rceil$  if and only if  $\lceil B \rceil$ .
- (ix) The above interpretations are then continued “down” the levels  $L_n$  until they stop at level  $L_0$ .

---

Please note that the above is not the only translations that can be applied to these formulas. Indeed, the electronic hardware known as switching circuits or gates can also be used to interpret these formulas. This hardware interpretation is what has produced the modern electronic computer.

Unfortunately, when translating from English or conversely the members of  $L$ , the above basic interpretations must be greatly expanded. The following is a list for reference purposes of the usual English constructions that can be properly interpreted by members of  $L$ .

- 
- (x) For any  $n \in \mathbb{N}$ ,  $A, B \in L_n$ ;  $\lceil A \leftrightarrow B \rceil$ :
    - (a)  $\lceil A \rceil$  if  $\lceil B \rceil$ , and  $\lceil B \rceil$  if  $\lceil A \rceil$ .
    - (b) If  $\lceil A \rceil$ , then  $\lceil B \rceil$ , and conversely.
    - (c)  $\lceil A \rceil$  is (a) necessary and sufficient (condition) for  $\lceil B \rceil$
    - (d)  $\lceil A \rceil$  is equivalent to  $\lceil B \rceil$ . (sometimes used in this manner)
    - (e)  $\lceil A \rceil$  exactly when  $\lceil B \rceil$ .
    - (f) If and only if  $\lceil A \rceil$ , (then)  $\lceil B \rceil$ .
    - (g)  $\lceil A \rceil$  exactly if  $\lceil B \rceil$ .
    - (h)  $\lceil A \rceil$  exactly if  $\lceil B \rceil$ .
    - (i)  $\lceil A \rceil$  is material equivalent to  $\lceil B \rceil$ .
  - (xi) For any  $n \in \mathbb{N}$ ,  $A, B \in L_n$ ;  $\lceil A \rightarrow B \rceil$ :
    - (a)  $\lceil B \rceil$  if  $\lceil A \rceil$ .
    - (b) When  $\lceil A \rceil$ , then  $\lceil B \rceil$ .
    - (c)  $\lceil A \rceil$  only when  $\lceil B \rceil$ .
    - (d)  $\lceil B \rceil$  in case  $\lceil A \rceil$ .
    - (e)  $\lceil A \rceil$  is a sufficient condition for  $\lceil B \rceil$ .
    - (f)  $\lceil B \rceil$  is a necessary condition for  $\lceil A \rceil$ .
    - (g)  $\lceil A \rceil$  materially implies  $\lceil B \rceil$ .
    - (h)  $\lceil A \rceil$  only if  $\lceil B \rceil$ .
    - (i)  $\lceil B \rceil$  when  $\lceil A \rceil$ .
    - (j) In case  $\lceil A \rceil$ ,  $\lceil B \rceil$ .
    - (k)  $\lceil A \rceil$  only in case  $\lceil B \rceil$ .
    - (l)  $\lceil A \rceil$  implies  $\lceil B \rceil$ .
  - (xii) For any  $n \in \mathbb{N}$ ,  $A, B \in L_n$ ;  $\lceil A \wedge B \rceil$ :
    - (a) Both  $\lceil A \rceil$  and  $\lceil B \rceil$ .
    - (b)  $\lceil A \rceil$  but  $\lceil B \rceil$ .
    - (c)  $\lceil A \rceil$  although  $\lceil B \rceil$ .
    - (d)  $\lceil A \rceil$  yet  $\lceil B \rceil$ .
    - (e) Not only  $\lceil A \rceil$  but  $\lceil B \rceil$ .
    - (f)  $\lceil A \rceil$  while  $\lceil B \rceil$ .
    - (g)  $\lceil A \rceil$  despite  $\lceil B \rceil$ .

---

(xiii) For any  $n \in \mathbb{N}$ ,  $A, B \in L_n$ ;  $\lceil A \vee B \rceil$ :

- (a)  $\lceil A \rceil$  or  $\lceil B \rceil$  or both. (d)  $\lceil A \rceil$  and/or  $\lceil B \rceil$   
(b)  $\lceil A \rceil$  unless  $\lceil B \rceil$ . (e) Either  $\lceil A \rceil$  or  $\lceil B \rceil$ . (usually)  
(c)  $\lceil A \rceil$  except when  $\lceil B \rceil$ . (usually)
- 

(xiv) For any  $n \in \mathbb{N}$ ,  $A, B \in L_n$ ;  $\lceil (A \vee B) \wedge (\neg(A \wedge B)) \rceil$ :

- (a)  $\lceil A \rceil$  or  $\lceil B \rceil$  not both. (c)  $\lceil A \rceil$  or else  $\lceil B \rceil$ . (usually)  
(b)  $\lceil A \rceil$  or  $\lceil B \rceil$ . (sometimes) (d) Either  $\lceil A \rceil$  or  $\lceil B \rceil$ . (sometimes)
- 

(xv) For any  $n \in \mathbb{N}$ ,  $A, B \in L_n$ ;  $\lceil (\neg(A \leftrightarrow B)) \rceil$ :  $\lceil ((\neg A) \leftrightarrow B) \rceil$ :

- (a)  $\lceil A \rceil$  unless  $\lceil B \rceil$ . (sometimes)
- 

(xvi) For any  $n \in \mathbb{N}$ ,  $A, B \in L_n$ ;  $\lceil (A \leftrightarrow (\neg B)) \rceil$ :

- (a)  $\lceil A \rceil$  except when  $\lceil B \rceil$ . (sometimes)
- 

(xvii) For any  $n \in \mathbb{N}$ ,  $A, B \in L_n$ ;  $\lceil (\neg(A \vee B)) \rceil$ :

- (a) Neither  $\lceil A \rceil$  nor  $\lceil B \rceil$ .
- 

(xviii) For any  $n \in \mathbb{N}$ ,  $A \in L_n$ ;  $\lceil (\neg A) \rceil$ :

Not  $\lceil A \rceil$  (or the result of transforming  $\lceil A \rceil$  to give the intent of “not” such as “ $\lceil A \rceil$  doesn’t hold” or “ $\lceil A \rceil$  isn’t so.”)

---

---

## EXERCISES 2.2

In what follows assume that  $P, Q, R, S \in L_0$ .

1. Let  $A$  represent each of the following strings of symbols. Determine if  $A \in L$  or  $A \notin L$ . State your conclusions.

- (a)  $A = (P \vee (Q \rightarrow (\neg S)))$  (f)  $A = (P) \vee ((\neg S))$   
(b)  $A = (P \leftrightarrow (Q \vee S))$  (g)  $A = (P \leftrightarrow (\neg(R \leftrightarrow S)))$   
(c)  $A = (P \rightarrow (S \wedge R))$  (h)  $A = (R \wedge (\neg(R \vee S)) \rightarrow P)$   
(d)  $A = ((P) \rightarrow (R \wedge S))$  (i)  $A = (P \wedge (P \wedge P) \rightarrow Q)$   
(e)  $A = (\neg P) \rightarrow (\neg(R \vee S))$  (j)  $A = ((P \wedge P) \rightarrow P \rightarrow P)$

2. Each of the following formula  $A$  are members of  $L$ . Find the size( $A$ ) of each.

- (a)  $A = ((P \vee Q) \rightarrow (S \rightarrow R))$  (c)  $A = (P \vee (Q \wedge (R \wedge S)))$   
(b)  $A = (((P \vee Q) \rightarrow R) \leftrightarrow S)$  (d)  $A = (((P \vee Q) \leftrightarrow (P \wedge Q)) \rightarrow S)$

3. Use the indicated atomic symbol to translate each of the following into a member of  $L$ .

- (a) Either (P) the port is open or (Q) someone left the shower on.  
(b) If (P) it is foggy tonight, then either (Q) the Captain will stay in his cabin or (R) he will call me to extra duty.  
(c) (P) Midshipman Jones will sit, and (Q) wait or (R) Midshipman George will wait.  
(d) Either (Q) I will go by bus or (R) (I will go) by airplane.  
(e) (P) Midshipman Jones will sit and (Q) wait, or (R) Midshipman George will wait.  
(f) Neither (P) Army nor (Q) Navy won the game.  
(g) If and only if the (P) sea-cocks are open, (Q) will the ship sink; (and) should the ship sink, then (R) we will go on the trip and (S) miss the dance.  
(h) If I am either (P) tired or (Q) hungry, then (R) I cannot study.  
(i) If (P) Midshipman Jones gets up and (Q) goes to class, (R) she will pass the quiz; and if she does not get up, then she will fail the quiz.

4. Let  $\lceil P \rceil$ : it is nice;  $\lceil Q \rceil$ : it is hot;  $\lceil R \rceil$ : it is cold;  $\lceil S \rceil$ : it is small. Translate (interpret) the following formula into acceptable non-ambiguous English sentences.

- (a)  $(P \rightarrow (\neg(Q \wedge R)))$  (d)  $((S \rightarrow Q) \vee P)$   
(b)  $(S \leftrightarrow P)$  (e)  $(P \leftrightarrow ((Q \wedge (\neg R)) \vee S))$

$$(c) (S \wedge (P \vee Q))$$

$$(f) ((S \rightarrow Q) \vee P)$$

### 2.3 Slight Simplification, Size, Common Pairs and Computers.

Each formula has a unique size  $n$ , where  $n$  is a natural number,  $\mathbb{N}$ , greater than or equal to zero. Now if  $\text{size}(A) = n$ , then  $A \in L_m$  for all  $m \geq n$ , and  $A \notin L_m$  for all  $m < n$ . For each formula that is not an atom, there appears a certain number of left “(” and right “)” parentheses. These parentheses occur in what is called *common pairs*. Prior to the one small simplification we may make to a formula, we’ll learn how to calculate which parentheses are common pairs. The common pairs are the parentheses that are included in a specific construction step for a specific level  $L_n$ . The method we’ll use can be mathematically established; however, its demonstration is somewhat long and tedious. Thus the “proof” will be omitted. The following is the *common pair rule*.

**Rule 2.3.1.** This is the common pair rule (CPR). Suppose that we are given an expression that is thought to be a member of  $L$ .

- (1) Select any left parenthesis “(.” Denote this parenthesis by the number +1.
- (2) Now moving towards the right, each time you arrive at another left parenthesis “(” add the number 1 to the previous number.
- (3) Now moving towards the right, each time you arrive at a right parenthesis “)” subtract the number 1 from the previous number.
- (4) **The first time** you come to a parenthesis that yields a ZERO by the above cumulative algebraic summation process, then that particular parenthesis is the companion parenthesis with which the first parenthesis you started with forms a common pair.

The common pair rule will allow us to find out what expressions within a formula are also formula. This rule will also allow us to determine the size of a formula. A formula is written in *atomic form* if only atoms, connectives, and parentheses appear in the formula.

**Definition 2.3.1** Non-atomic subformula.

Given an  $A \in L$  (written in atomic form). A subformula is any expression that appears between and includes a common pair of parentheses.

Note that according to Definition 2.3.1, the formula  $A$  is a subformula. I now state, without proof, the theorem that allows us to determine the size of a formula.

**Theorem 2.3.1** Let  $A \in L$  and  $A$  is written in atomic form. If there does not exist a parenthesis in  $A$ , then  $A \in L_0$  and  $A$  has size zero. If there exists a left most parenthesis “(” [i.e. no more parentheses appear on the left in the expression], then beginning with this parenthesis the common pair rule will yield a right most parenthesis for the common pair. During this common pair procedure, the largest natural number obtained will be the size of  $A$ .

**Example 2.3.1.** The numbers in the next display are obtained by starting with parenthesis  $a$  and show that the  $\text{size}(A) = 3$ .

$$\begin{array}{cccccccc}
 A = & ( & ( & ( & P \wedge Q & ) & \vee R & ) & \rightarrow & ( & S \vee P & ) & ) \\
 & a & b & c & & d & & e & & f & & g & h \\
 & 1 & 2 & 3 & & 2 & & 1 & & 2 & & 1 & 0
 \end{array}$$

Although the common pairs are rather obvious, the common pair rule can be used. This gives (c,d), (b,e), (f,g), and (a,h) as common pairs. Hence, the subformula are  $A$ ,  $(P \wedge Q)$ ,  $((P \wedge Q) \vee R)$ ,  $(S \vee P)$  and you can apply the common pair rule to each of these to find their sizes. Of course, the rule is most useful when the formula are much more complex.

There are various simplification processes that allow for the removal of many of the parenthesis. One might think that logicians like to do this since those that do not know the simplifications would not have any knowledge as to what the formula actually looks like. The real reason is to simply write less. These

simplification rules are relative to a listing of the strengths of the connectives. However, for this beginning course, such simplification rules are not important with one exception.

---

**Definition 2.3.2** The one simplification that may be applied is the removal of the outermost left parenthesis “(” and the outermost right parenthesis “).” It should be obvious when such parentheses have been removed. BUT, they must be inserted prior to application of the common pair rule and Theorem 2.3.1.

---

One of the major applications of the propositional calculus is in the design of the modern electronic computer. This design is based upon the basic and simplest behavior of the logical network which itself is based upon the simple idea of switching circuits. Each switching device is used to produce the various types of “gates.” These gates will not specifically be identified but the basic switches will be identified. Such switches are conceived of as simple single pole relays. A switch may be *normally open* when no current flows through the coil. One the other hand, the switch could be normally closed when no current flows. When current flows through the relay coil, the switch takes the opposite state. The coil is not shown only the circuit that is formed or broken when the coil is energized for the  $P$  or  $Q$  relay. The action is “current through a coil” and leads to or prevents current flowing through the indicated line.

For what follows the atoms of our propositional calculus represent relays in the normally open position. Diagrammatically, a normally open relay (switch) is symbolized as follows:



Now for each atom  $P$ , let  $\neg P$  represent a normally closed relay. Diagrammatically, a normally closed relay is symbolized by:



Now any set of normally open or closed relays can be wired together in various ways. For the normally open ones, the following will model the binary connectives  $\rightarrow$ ,  $\leftrightarrow$ ,  $\wedge$ ,  $\vee$ . This gives a non-linguistic model. In the following,  $P$ ,  $Q$  are atoms and the relays are normally open.

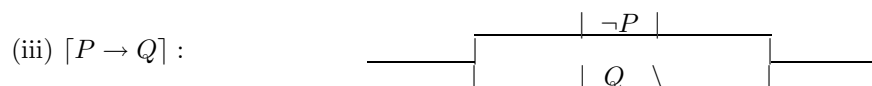
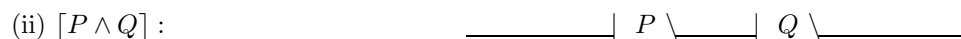
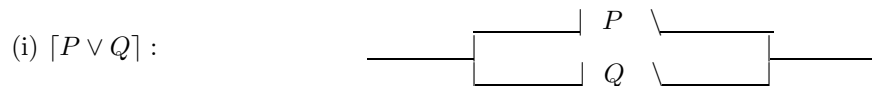

(iv) In order to model the expression  $P \leftrightarrow Q$  we need two coils. The  $P$  coil has a switch at both ends, one normally open the other normally closed. The  $Q$  coil has a switch at both ends, one normally open the other normally closed. But, the behavior of the two coils is opposite from one another as shown in the following diagram, where (iii) denotes the previous diagram.

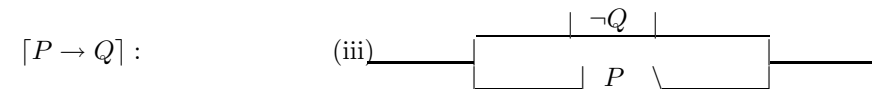

---

### EXERCISES 2.3

1. When a formula is written in atomic form, the (i) atoms, (ii) (not necessary distinct) connectives, and (iii) the parentheses are displayed. Of the three collections (i), (ii), (iii), find the one collection that can be used to determine immediately by counting the (a) number of common pairs and (b) the number of subformula. What is it that you count?
2. For each of the following formula, use the indicated letter and list as order pairs, as I have done for Example 2.3.1 on page 16, the letters that identify the common pairs of parentheses.

$$(A) = ((P \rightarrow (Q \vee R)) \leftrightarrow (\neg S))$$

ab    c    de    f    gh

$$(B) = ((P \vee (Q \vee (S \vee Q))) \rightarrow (\neg(\neg R)))$$

ab    c    d    efg    h i    jkm

$$(C) = (((\neg(P \leftrightarrow (\neg R))) \rightarrow ((\neg Q) \leftrightarrow (R \vee P))) \leftrightarrow S)$$

abc d    e    fgh    ij    k    m    nop    q

3. Find the size of each of the formula in problem 3 above.

4. Although it would not be the most efficient, (we will learn how to find logically equivalent formula so that we can make them more efficient), use the basic relay (switching) circuits described in this section (i.e. combine them together) so that the circuits will model the following formula.

(a) $((P \vee Q) \wedge (\neg R))$	(c) $((\neg P) \wedge Q) \vee ((\neg Q) \wedge P)$
(b) $((P \rightarrow Q) \vee (Q \rightarrow P))$	(d) $((P \wedge Q) \wedge (R \vee S))$

## 2.4 Model Theory – Basic Semantics.

Prior to 1921 this section could not have been rigorously written. It was not until that time when Emil Post convincingly established that the *semantics* for the language  $L$  and the seemingly more complex formal approach to Logic as practiced in the years prior to 1921 are equivalent. The semantical ideas had briefly been considered for some years prior to 1921. However, Post was apparently the first to investigate rigorously such concepts. It has been said that much of modern mathematics and various simplifications came about since “we are standing on the shoulders of giants.” This is, especially, true when we consider today’s simplified semantics for  $L$ .

Now the term *semantics* means that we are going to give a special meaning to each member of  $L$  and supply rules to obtain these “meanings” from the atoms and connectives whenever a formula is written in atomic form (i.e. only atoms, connectives and parentheses appear). These meanings will “mirror” or “model” the behavior of the classical concepts of “truth” and “falsity.” HOWEVER, so as not to impart any philosophical meanings to our semantics until later, we replace “truth” by the letter  $T$  and “falsity” by the  $F$ .

In the applications of the following semantical rules to the real world, it is often better to model the  $T$  by the concept “occurs in reality” and the  $F$  by the concept “does not occur in reality.” Further, in many cases, the words “in reality” may not be justified.

**Definition 2.4.1** The following is the idea of an *assignment*. Let  $A \in L$  and assume that  $A$  is written in atomic form. Then there exists some natural number  $n$  such that  $A \in L_n$  and  $\text{size}(A) = n$ . Now there is in  $A$  a finite list of distinct atoms, say  $(P_1, P_2, \dots, P_m)$  reading left to right. We will assign to each  $P_i$  in the list the symbol T or the symbol F in as many different ways as possible. If there are  $n$  different atoms, there will be  $2^n$  different arrangements of such Ts and Fs. These are the *values* of the assignment. This can be diagrammed as follows:

$$\begin{array}{c} (P_1, P_2, \dots, P_m) \\ (\downarrow \downarrow \dots \downarrow) \\ (T, F, \dots, T) \end{array}$$

**Example 2.4.1** This is the example that shows how to give a standard fixed method to display and find all of the different arrangements of the Ts and Fs for, say three atoms,  $P, Q, R$ . There would be a total of 8 different arrangements. Please note how I’ve generated the first, second and third columns of the following “assignment” table. This same idea can be used to generate quickly an assignment table for any finite number of atoms.

$P$	$Q$	$R$
$T$	$T$	$T$
$T$	$T$	$F$
$T$	$F$	$T$
$T$	$F$	$F$
$F$	$T$	$T$
$F$	$T$	$F$
$F$	$F$	$T$
$F$	$F$	$F$

The rows in the above table represent one assignment (these are also called truth-value assignments) and such an assignment will be denoted by symbols such as  $\underline{a} = (a_1, a_2, a_3)$ , where the  $a_i$  take the value  $T$  or  $F$ . In practice, one could re-write these assignments in terms of the numbers 1 and 0 if one wanted to remove any association with the philosophical concept of “truth” or “falsity.”

For this fundamental discussion, we will assume that the list of atoms in a formula  $A \in L$  is known and we wish to define in an appropriate manner the intuitive concept of the truth-value for the formula  $A$  for a specific assignment  $\underline{a}$ . Hence you are given  $\underline{a} = (a_1, a_2, \dots, a_n)$  that corresponds to the atoms  $(P_1, P_2, \dots, P_n)$  in  $A$  and we want a definition that will allow us to determine inductively a unique “truth-value” from  $\{T, F\}$  that corresponds to  $A$  for the assignment  $\underline{a}$ .

---

**Definition 2.4.2** The truth-value for a given formula  $A$  and a given assignment  $\underline{a}$  is denoted by  $v(A, \underline{a})$ . The procedure that we’ll use is called a *valuation procedure*.

---

Prior to presenting the valuation procedure, let’s make a few observations. If you take a formula with  $m$  distinct atoms, then the assignments  $\underline{a}$  are exactly the same for *any* formula with  $m$  distinct atoms no matter what they are.

- (1) An assignment  $\underline{a}$  only depends upon the number of distinct atoms and not the actual atoms themselves.
- (2) Any rule that assigns a truth-value  $T$  or  $F$  to a formula  $A$ , where  $A$  is not an atom must depend only upon the connectives contained in the formula.
- (3) For any formula with  $m$  distinct atoms, changing the names of the  $m$  distinct atoms to different atoms that are distinct will not change the assignments.

Now, we have another observation based upon the table of assignments that appears on page 20. This assignment table is for three distinct atoms. Investigation of just two of the columns yields the following:

- (4) For any assignment table for  $m$  atoms, any  $n$  columns, where  $1 \leq n \leq m$  can be used to obtain (with possible repetition) all of the assignments that correspond to a set of  $n$  atoms.

The actual formal inductively defined valuation procedure is given in the appendix and is based upon the size of a formula. This formal procedure is not the actual way must mathematicians obtain  $v(A, \underline{a})$  for a given  $A$ , however. What’s presented next is the usual informal (intuitive) procedure that’s used. It’s called



the truth-table procedure and is based upon the ability of the human mind to take a general statement and to apply that statement in a step-by-step manner to specific cases. There are five basic truth-tables.

The  $A, B$  are *any* two formula in  $L$ . As indicated above we need only to define the truth-value for the five connectives.

(i)	
$A$	$\neg A$
$T$	$F$
$F$	$T$

(ii)		
$A$	$B$	$A \vee B$
$T$	$T$	$T$
$T$	$F$	$T$
$F$	$T$	$T$
$F$	$F$	$F$

(iii)		
$A$	$B$	$A \wedge B$
$T$	$T$	$T$
$T$	$F$	$F$
$F$	$T$	$F$
$F$	$F$	$F$

(iv)		
$A$	$B$	$A \rightarrow B$
$T$	$T$	$T$
$T$	$F$	$F$
$F$	$T$	$T$
$F$	$F$	$T$

(v)		
$A$	$B$	$A \leftrightarrow B$
$T$	$T$	$T$
$T$	$F$	$F$
$F$	$T$	$F$
$F$	$F$	$T$

Observe that the actual truth-value for a connective does not depend upon the symbols  $A$  or  $B$  but only upon the values  $T$  or  $F$ . For this reason the above general truth-tables can be replaced with a simple collection of statements relating the  $T$  and  $F$  and the connectives only. This is the quickest way to find the truth-values, simply concentrate upon the connectives and use the following:

- (i)  $\overset{\neg F}{T}, \overset{\neg T}{F}$ .
- (ii)  $\overset{T \vee T}{T}, \overset{T \vee F}{T}, \overset{F \vee T}{T}, \overset{F \vee F}{F}$
- (iii)  $\overset{T \wedge T}{T}, \overset{T \wedge F}{F}, \overset{F \wedge T}{F}, \overset{F \wedge F}{F}$
- (iv)  $\overset{T \rightarrow T}{T}, \overset{T \rightarrow F}{F}, \overset{F \rightarrow T}{T}, \overset{F \rightarrow F}{T}$
- (v)  $\overset{T \leftrightarrow T}{T}, \overset{T \leftrightarrow F}{F}, \overset{F \leftrightarrow T}{F}, \overset{F \leftrightarrow F}{T}$

The procedures will now be applied in a step-by-step manner to find the truth-values for a specific formula. This will be displayed as a truth-table with the values in the last column. Remember that the actual truth-table can contain many more atoms than those that appear in a given formula. By using all the distinct atoms contained in all the formulas, one truth-table can be used to find the truth values for more than one formula.

The construction of a truth-table is best understood by example. In the following example, the numbers 1, 2, 3, 4 for the rows and the letters a, b, c, d, e, f that identify the columns are used here for reference only and are not used in the actual construction.

**Example 2.4.2** Truth-values for the formula  $A = (((\neg P) \vee R) \rightarrow (P \leftrightarrow R))$ .

	$P$	$R$	$\neg P$	$(\neg P) \vee R$	$P \leftrightarrow R$	$v(A, \underline{a})$
(1)	$T$	$T$	$F$	$T$	$T$	$T$
(2)	$T$	$F$	$F$	$F$	$F$	$T$
(3)	$F$	$T$	$T$	$T$	$F$	$F$
(4)	$F$	$F$	$T$	$T$	$T$	$T$
	a	b	c	d	e	f

Now I'll go step-by-step through the above process using the general truth-tables on the previous page.

(i) Columns (a) and (b) are written down with their usual patterns.

(ii) Now go to column (a) only to calculate the truth-values in column (c). Note as mentioned previously there will be repetitions.

(iii) Now calculate (d) for the  $\vee$  connective using the truth-values in columns (b) and (c).

(iv) Next calculate (e) for the  $\leftrightarrow$  connective using columns (a) and (b).

(v) Finally, calculate (f), the value we want, for the  $\rightarrow$  connective using columns (d) and (e).

## EXERCISES 2.4

1. First, we assign the indicated truth values for the indicated atoms  $v(P) = T$ ,  $v(Q) = F$ ,  $v(R) = F$  and  $v(S) = T$ . These values will yield one row of a truth-table, one assignment  $\underline{a}$ . For this assignment, find the truth-value for the indicated formula. (Recall that  $v(A, \underline{a})$  means the unique truth-value for the formula  $A$ .)

(a)  $v((R \rightarrow (S \vee P)), \underline{a})$

(d)  $v((((\neg S) \vee Q) \rightarrow (P \leftrightarrow S)), \underline{a})$

(b)  $v(((P \vee R) \leftrightarrow (R \wedge (\neg S))), \underline{a})$

(e)  $v((((P \vee (\neg Q)) \vee R) \rightarrow ((\neg S) \wedge S)), \underline{a})$

(c)  $v((S \leftrightarrow (P \rightarrow ((\neg P) \vee S))), \underline{a})$

2. Construct complete truth tables for each of the following formula.

(a)  $(P \rightarrow (Q \rightarrow P))$

(c)  $((P \rightarrow Q) \leftrightarrow (P \vee (\neg Q)))$

(b)  $((P \vee Q) \leftrightarrow (Q \vee P))$

(d)  $((Q \wedge P) \rightarrow ((Q \vee (\neg Q)) \rightarrow (R \vee Q)))$

3. For each of the following determine whether or not the truth-value information given will yield a unique truth-value for the formula. State your conclusions. If the information is sufficient, then give the unique truth-value for the formula.

(a)  $(P \rightarrow Q) \rightarrow R$ ,  $v(R) = T$

(d)  $(R \rightarrow Q) \leftrightarrow Q$ ,  $v(R) = T$

(b)  $P \wedge (Q \rightarrow R)$ ,  $v(Q \rightarrow R) = F$

(e)  $(P \rightarrow Q) \rightarrow R$ ,  $v(Q) = F$

(c)  $(P \rightarrow Q) \rightarrow ((\neg Q) \rightarrow (\neg P))$

(f)  $(P \vee (\neg P)) \rightarrow R$ ,  $v(R) = F$

For (c),  $v(Q) = T$

## 2.5 Valid Formula.

There may be something special about those formula that take the value  $T$  for *any* assignment.

---

**Definition 2.5.1** (Valid formulas and contradictions). Let  $A \in L$ . If for every assignment  $\underline{a}$  to the atoms in  $A$ ,  $v(A, \underline{a}) = T$ , then  $A$  is called a *valid* formula. If to every assignment  $\underline{a}$  to the atoms of  $A$ ,  $v(A, \underline{a}) = F$ , then  $A$  is called a (*semantical*) contradiction. If a formula  $A$  is valid, we use the notation  $\models A$  to indicate this fact.

---

If we are given a formula in atomic form, then a simple truth-table construction will determine whether or not it is a valid formula or a contradiction. Indeed,  $A$  is valid if and only if the column under the  $A$  in its truth-table contains only  $T$  in each position. A formula  $A$  is a contradiction if and only if the column contains only  $F$  in every position. From our definition, we read the expression  $\models A$  “ $A$  is a valid formula.” We read the notation  $\not\models A$  “ $A$  is not a valid formula. Although a contradiction is not a valid formula, there are infinitely many formula that are not valid AND not a contradiction.

**Example 2.5.1** Let  $P, Q \in L_0$ .

(i)  $\models P \rightarrow P$

$P$	$P \rightarrow P$
$T$	$T$
$F$	$T$

(ii)  $\models P \rightarrow (Q \rightarrow P)$

$P$	$Q$	$Q \rightarrow P$	$P \rightarrow (Q \rightarrow P)$
$T$	$T$	$T$	$T$
$T$	$F$	$T$	$T$
$F$	$T$	$F$	$T$
$F$	$F$	$T$	$T$

(iii)  $\not\models P \rightarrow Q$

$P$	$Q$	$P \rightarrow Q$
$T$	$T$	$T$
$T$	$F$	$F$
$F$	$T$	$T$
$F$	$F$	$T$

(iv) contradiction  $P \wedge (\neg P)$

$P$	$\neg P$	$P \wedge (\neg P)$
$T$	$F$	$F$
$F$	$T$	$F$

We now begin the mathematical study of the validity concept.

---

*Throughout this text, I will “prove” various theorems in a way that is acceptable to the mathematical community. Since the major purpose for this book is NOT to produce trained mathematical logicians, but, rather, to give the tools necessary to apply certain results from the discipline to other areas, I, usually, don’t require a student to learn either these “proofs” or the methods used to obtain the proofs.*

---

**Theorem 2.5.1** A formula  $A \in L$  is valid if and only if  $\neg A$  is a contradiction.

*Proof.* First, notice that  $\underline{a}$  is an assignment for  $A$  if and only if  $\underline{a}$  is an assignment for  $\neg A$ . Assume that  $\models A$ . Then for any  $\underline{a}$  for  $A$ ,  $v(A, \underline{a}) = T$ . Consequently, from the definition of  $v$ ,  $v(\neg A, \underline{a}) = F$ . Since  $\underline{a}$  is any arbitrary assignment, then  $v(\neg A, \underline{a}) = F$  for all assignment  $\underline{a}$ .

Conversely, let  $\underline{a}$  be any assignment to the atoms in  $\neg A$ . Then  $\underline{a}$  is an assignment to the atoms in  $A$ . Since  $\neg A$  is a contradiction,  $v(\neg A, \underline{a}) = F$ . From the truth-table (or the formal result in the appendix), it

follows that  $v(A, \underline{a}) = T$ . Once again, since  $\underline{a}$  is an arbitrary assignment, this yields that  $v(A, \underline{a}) = T$  for all assignments and, thus,  $\models A$ . ■

Valid formula are important elements in our investigation of the propositional logic. It's natural to ask whether or not the validity of a formula is completely dependent upon its atomic components or its connectives? To answer this question, we need to introduce the following *substitution process*.

---

**Definition 2.5.2** (Atomic substitution process.) Let  $A \in L$  be written in atomic form. Let  $P_1, \dots, P_n$  denote the atoms in  $A$ . Now let  $A_1, \dots, A_n$  be ANY (not necessarily distinct) members of  $L$ . Define  $A^*$  to be the result of substituting for each and every appearance of an atom  $P_i$  the corresponding formula  $A_i$ .

---

**Theorem 2.5.2** Let  $A \in L$ . If  $\models A$ , then  $\models A^*$ .

Proof. Let  $\underline{a}$  be any assignment to the atoms in  $A^*$ . In the step-by-step valuation process there is a level  $L_m$  where the formula  $A^*$  first appears. In the valuation process, at level  $L_m$  each constituent of  $A^*$  takes on the value  $T$  or  $F$ . Since the truth-value of  $A^*$  only depends upon the connectives (they are independent of the symbols used for the formulas) and the truth-values of the  $v(A_i, \underline{a})$  are but an assignment  $\underline{b}$  that can be applied to the original atoms  $P_1, \dots, P_n$ , it follows that  $v(A^*, \underline{a}) = v(A, \underline{b}) = T$ . But,  $\underline{a}$  is an arbitrary assignment for  $A^*$ . Hence,  $\models A^*$ . ■

**Example 2.5.2** Assume that  $P, Q \in L_0$ . Then we know that  $\models P \rightarrow (Q \rightarrow P)$ . Now let  $A, B \in L$  be any formula. Then  $\models A \rightarrow (B \rightarrow A)$ . In particular, letting  $A = (P \rightarrow Q)$ ,  $B = (R \rightarrow S)$ , where  $P, Q, R, S \in L_0$ , then  $\models (P \rightarrow Q) \rightarrow ((R \rightarrow S) \rightarrow (P \rightarrow Q))$ .

Theorem 2.5.2 yields a simplification to the determination of a valid formula written with *some* connectives displayed. If you show that  $v(A, \underline{c}) = T$  where you have created all of the possible assignments  $\underline{c}$  not to the atoms of  $A$  but only for the displayed components, then  $\models A$ . (You think of the components as atoms.) Now the reason that this non-atomic method can be utilized follows from our previous results. Suppose that we have a list of components  $A_1, \dots, A_n$  and we substitute for each distinct component of  $A$  a distinct atom in place of the components. Then any truth-value we give to the original components, becomes an assignment  $\underline{a}$  for this newly created formula  $A'$ . Observe that using  $A_1, \dots, A_n$  it follows that  $(A')^* = A$ . Now application of theorem 2.5.2 yields if  $\models A'$ , then  $\models A$ . What this means is that whenever we wish to establish validity for a formula we may consider it written in component variables and make assignments only to these variables; if the last column is all Ts, then the original formula is valid.

---

**WARNING:** We cannot use the simplified version to show that a formula is NOT valid. As a counter example, let  $A, B \in L$ . Then if we assume that  $A, B$  behave like atoms and want to show that the composite formula  $A \rightarrow B$  is not valid and follow that procedure thinking it will show non-validity, we would, indeed, have an  $F$  at one row of the truth-table. But if  $A = B = P$ , which could be the case since  $A, B$  are propositional language variables, then we have a contradiction since  $\models P \rightarrow P$ . Hence, the formula can be considered as written in non-atomic form only if it tests to be valid.

---

It's interesting to note the close relation which exists between set-theory and logic. Assume that we interpret propositional symbols as names for sets which are subsets of an infinite set  $X$ . Then interpret the conjunction as set-theoretic intersection (i.e.  $[\wedge] : \cap$ ), the disjunction as set-theoretic union (i.e.  $[\vee] : \cup$ ), the negation as set-theoretic complementation with respect to  $X$  (i.e.  $[\neg] : X - \text{ or } X \setminus$ ), and the combination of validity with the biconditional to be set-theoretical equality (i.e.  $[\leftrightarrow] : A = B$ ). Now the valid formula  $(P \wedge ((Q \vee R))) \leftrightarrow ((P \wedge Q) \vee (P \wedge R))$  translates into the correct set-theoretic expression  $(P \cap ((Q \cup R))) = ((P \cap Q) \cup (P \cap R))$ . Now in this text we will NOT use the known set-theoretic facts to establish a valid formula even though some authors do so within the setting of the theory known as a Boolean algebra. This idea would not be a circular approach since the logic used to determine these set-theoretic expressions is the metalogic of mathematics.

In the next theorem, we give, FOR REFERENCE PURPOSES, an important list of formula each of which can be establish as valid by the simplified procedure of using only language variables.

**Theorem 2.5.3** *Let  $A, B, C$  be any members of  $L$ . Then the symbol  $\models$  can be place before each of the following formula.*

- |  |   |
|--|---|
| (1) $A \rightarrow (B \rightarrow A)$  | (8) $B \rightarrow (A \vee B)$  |
| (2) $(A \rightarrow (B \rightarrow C)) \rightarrow$<br>$((A \rightarrow B) \rightarrow (A \rightarrow C))$ | (9) $(A \rightarrow C) \rightarrow ((B \rightarrow C) \rightarrow$<br>$((A \vee B) \rightarrow C))$ |
| (3) $(A \rightarrow B) \rightarrow$<br>$((A \rightarrow (B \rightarrow C)) \rightarrow (A \rightarrow C))$ | (10) $(A \rightarrow B) \rightarrow ((A \rightarrow (\neg B)) \rightarrow (\neg A))$                |
| (4) $A \rightarrow (B \rightarrow (A \wedge B))$   | (11) $(A \rightarrow B) \rightarrow$<br>$((B \rightarrow A) \rightarrow (A \leftrightarrow B))$     |
| (5) $(A \wedge B) \rightarrow A$   | (12) $(\neg(\neg A)) \rightarrow A$   |
| (6) $(A \wedge B) \rightarrow B$   | (13) $(A \leftrightarrow B) \rightarrow (A \rightarrow B)$  |
| (7) $A \rightarrow (A \vee B)$   | (14) $(A \leftrightarrow B) \rightarrow (B \rightarrow A)$  |
| .....  | .....   |
| (15) $A \rightarrow A$   | (17) $(A \rightarrow B) \rightarrow ((B \rightarrow C) \rightarrow$<br>$(A \rightarrow C))$         |
| (16) $(A \rightarrow (B \rightarrow C)) \leftrightarrow$<br>$(B \rightarrow (A \rightarrow C))$            | (18) $(A \rightarrow (B \rightarrow C)) \leftrightarrow ((A \wedge B) \rightarrow C)$               |
| .....  | .....   |
| (19) $(\neg A) \rightarrow (A \rightarrow B)$  | (20) $((\neg A) \rightarrow (\neg B)) \leftrightarrow (B \rightarrow A)$                            |
|  | (21) $((\neg A) \rightarrow (\neg B)) \rightarrow (B \rightarrow A)$                                |
| .....  | .....   |
| (22) $A \leftrightarrow A$   | (23) $(A \leftrightarrow B) \leftrightarrow (B \leftrightarrow A)$                                  |
|  | (24) $((A \leftrightarrow B) \wedge (B \leftrightarrow C)) \rightarrow (A \leftrightarrow C)$       |
| .....  | .....   |
| (25) $((A \wedge B) \wedge C) \leftrightarrow (A \wedge (B \wedge C))$                                     | (30) $((A \vee B) \vee C) \leftrightarrow (A \vee (B \vee C))$                                      |
| (26) $(A \wedge B) \leftrightarrow (B \wedge A)$   | (31) $(A \vee B) \leftrightarrow (B \vee A)$  |
| (27) $(A \wedge (B \vee C)) \leftrightarrow$<br>$((A \wedge B) \vee (A \wedge C))$                         | (32) $(A \vee (B \wedge C)) \leftrightarrow$<br>$((A \vee B) \wedge (A \vee C))$                    |
| (28) $(A \wedge A) \leftrightarrow A$  | (33) $(A \vee A) \leftrightarrow A$   |
| (29) $(A \wedge (A \vee B)) \leftrightarrow A$   | (34) $(A \vee (A \wedge B)) \leftrightarrow A$  |
| .....  | .....   |
| (35) $(\neg(\neg A)) \leftrightarrow A$  | (36) $\neg(A \wedge (\neg A))$  |
|  | (37) $A \vee (\neg A)$  |
| .....  | .....   |
| (38) $(\neg(A \vee B)) \leftrightarrow ((\neg A) \wedge (\neg B))$   | (39) $(\neg(A \wedge B)) \leftrightarrow ((\neg A) \vee (\neg B))$                                  |
|  | (40) $(\neg(A \rightarrow B)) \leftrightarrow (A \wedge ((\neg B)))$                                |
| .....  | .....   |
| (41) $(A \vee B) \leftrightarrow (\neg((\neg A) \wedge (\neg B)))$   | (44) $(A \wedge B) \leftrightarrow (\neg((\neg A) \vee (\neg B)))$                                  |
| (42) $(A \rightarrow B) \leftrightarrow (\neg(A \wedge (\neg B)))$   | (45) $(A \rightarrow B) \leftrightarrow ((\neg A) \vee B)$  |
| (43) $(A \wedge B) \leftrightarrow (\neg(A \rightarrow (\neg B)))$   | (46) $(A \vee B) \leftrightarrow ((\neg A) \rightarrow B)$  |

$$(47) (A \leftrightarrow B) \leftrightarrow ((A \rightarrow B) \wedge (B \rightarrow A))$$

---

---

### EXERCISES 2.5

(1) Use the truth-table method to establish that formula (1), (2), (21), (32), and (47) of theorem 2.4.3 are valid.

(2) Determine by truth-table methods whether or not the following formula are contradictions.

(a)  $((\neg A) \vee (\neg B)) \leftrightarrow$   
 $(\neg((\neg A) \vee (\neg B)))$

(c)  $(\neg(A \rightarrow B)) \leftrightarrow ((\neg A) \vee B)$

(b)  $(\neg A) \rightarrow (A \vee B)$

(d)  $((A \vee (\neg B)) \wedge (\neg P)) \leftrightarrow$   
 $((\neg A) \vee B) \vee P$

---

---

### 2.6 Equivalent Formula.

As it will be seen in future sections, one major objective is to investigate the classical human deductive processes and how these relate to the logic operator used in the solution to the General Grand Unification Problem. In order to accomplish this, it has been discovered that humankind seems to believe that certain logical statements can be substituted completely for other logical statements without effecting the general “logic” behind an argument. Even though this fact will not be examined completely in this section, we will begin its investigation.

Throughout mathematics the most basic concept is the relation which is often called *equality*. In the foundations of mathematics, there’s a difference between equality, which means that objects are identically the same (i.e. they cannot be distinguished one from another by any property for the collection that contains them), and certain relations which *behave* like equality but that can be distinguished one from another and do not allow for substitution of one for another.

**Example 2.6.1** When you first defined the rational numbers from the integers you were told the strange fact that  $1/2$ ,  $2/4$ ,  $3/6$  are “equal” but they certainly appear to be composed of distinctly different symbols and would not be identical from our logical viewpoint.

We are faced with two basic difficulties. In certain areas of mathematical logic, it would be correct to consider the *symbols*  $1/2$ ,  $2/4$ ,  $3/6$  as names for a single unique object. On the other hand, if we were studying the symbols themselves, then  $1/2$ ,  $2/4$ ,  $3/6$  would not be consider as names for the same object but, rather, they are distinctly different symbols. These differences need not be defined specifically but can remain on the intuitive level for the moment. There are two types of “equality” relations. One type simple behaves like equality but does not allow for substitution, in general. But then we have another type that behaves like equality and does allow for substitution with *respect to certain properties*. This means that these two objects are identical as far as these properties are concerned. Or, saying it another way, a set of properties cannot distinguish between two such objects, while another set of properties can distinguish them one from another.

Recall that a *binary relation* “on” any set  $X$  can be thought of as simply a set of ordered pairs  $(a, b)$  that, from a symbol string viewpoint, has an ordering. The first *coordinate* is the element you meet first in writing this symbol from left to right, in this case the  $a$ . The second coordinate is the next element you arrive at, in this case the  $b$ . Also recall that two ordered pairs are identical (you can substitute one for another throughout your mathematical theory) if their first coordinates are identical and their second coordinates are identical (i.e. can not be distinguished one from another by the defining properties for the set in which they are contained.) The word “on” means that the set of all first coordinates is  $X$  and the set of all second

coordinates is  $X$ . Now there are two ways of symbolizing such a binary relation, either by writing it as a set of ordered pairs  $R$  or by doing the following:

---

**Definition 2.6.1** (Symbolizing ordered pairs.) Let  $R$  be a nonempty set of ordered pairs. Then  $(a, b) \in R$  if and only if  $a R b$ . The expression  $a R b$  is read “ $a$  is  $R$  related to  $b$ ” or similar types of expressions.

---

In definition 2.6.1, the reason the second form is used is that many times it’s simply easier to write a binary relation’s defining properties when the  $a R b$  is used. It’s this form we use to define a very significant binary relation that gives the concept of behaving like “equality.”

---

**Definition 2.6.2** (The equivalence relation.) A binary relation  $\equiv$  on a set  $X$  is called an *equivalence relation* if for each  $a, b, c \in X$  it follows that

- (i)  $a \equiv a$  (Reflexive property).
  - (ii) If  $a \equiv b$ , then  $b \equiv a$ . (Symmetric property).
  - (iii) If  $a \equiv b$  and  $b \equiv c$ , then  $a \equiv c$ . (Transitive property).
- 

Now when we let  $X = L$ , then the only identity or equality we use is the intuitive identity. Recall that this means that two symbol string are recognized as congruent geometric configurations or are intuitively similar strings of symbols. This would yield a trivial equivalence relation. As a set of ordered pairs, an identity relation is  $\{(a, a) \mid a \in X\}$ , which is (i) in definition 2.6.2. Parts (ii), (iii) also hold for this identity relation.

For the next theorem, please recall that the validity of a formula  $A$  does not depend upon an assignment  $\underline{a}$  that contains MORE members than the number of atoms contained in  $A$ . Such an assignment is used by restricting the Ts and Fs to those atoms that are in  $A$ .

**Theorem 2.6.1**

Let  $A, B \in L$  and  $\underline{a}$  an arbitrary assignment to the atoms that are in  $A$  and  $B$ .

- (i) Then  $v(A \leftrightarrow B, \underline{a}) = T$  if and only if  $v(A, \underline{a}) = v(B, \underline{a})$ .
- (ii)  $\models A \leftrightarrow B$  if and only if for any assignment  $\underline{a}$  to the atoms that are in  $A$  and  $B$ ,  $v(A, \underline{a}) = v(B, \underline{a})$ .

Proof. Let  $A, B \in L$ .

(i) Then let the size( $A \leftrightarrow B$ ) =  $n \geq 1$ . Then  $A, B \in L_{n-1}$ . This result now follows from the general truth-tables on page 22.

(ii) Assume that  $\models A \leftrightarrow B$  and let  $\underline{a}$  be an arbitrary assignment to the atoms that are contained in  $A$  and  $B$ . Then  $v(A \leftrightarrow B, \underline{a}) = T$  if and only if  $v(A, \underline{a}) = v(B, \underline{a})$  from part (i). Conversely, assume that  $\underline{a}$  is an assignment for the atoms in  $A$  and  $B$ . Then  $\underline{a}$  also determines an assignment for  $A$  and  $B$  separately. Since,  $v(A, \underline{a}) = v(B, \underline{a})$  then from (i), it follows that  $v(A \leftrightarrow B, \underline{a}) = T$ . But  $\underline{a}$  is arbitrary, hence,  $\models A \leftrightarrow B$ . ■

---

**Definition 2.6.3** (The logical equivalence relation  $\equiv$ .) Let  $A, B \in L$ . Then define  $A \equiv B$  iff  $\models A \leftrightarrow B$ .

---

Notice that definition 2.6.3 is easily remembered by simply dropping the  $\models$  and replacing  $\leftrightarrow$  with  $\equiv$ . Before we proceed to the study of equivalent propositional formulas, I’ll anticipate a question that almost always arises after the next few theorems. What is so important about equivalent formula? When we study the actual process of logical deduction, you’ll find out that within any classical propositional deduction a formula  $A$  can be substituted for an equivalent formula and this will in no way affect the deductive conclusions. What it may do is to present a more easily followed logical process. This is exactly what happens if one truly wants to understand real world logical arguments. For example, take a look at theorem 2.5.3 parts (29) and (34) and notice how logical arguments can be made more complex, unnecessarily, by

adding some rather complex statements, statements that include totally worthless additional statements such as any additional statement  $B$  that might be selected simply to confuse the reader.

**Theorem 2.6.2** *The relation  $\equiv$  is an equivalence relation defined on  $L$ .*

Proof. Let  $A, B, C \in L$ . From the list of valid formula that appear in theorem 2.5.3, formula (22) yields that for each  $A \in L$ ,  $\models A \leftrightarrow A$ . Hence,  $A \equiv A$ .

Now let  $A, B \in L$  and assume that  $A \equiv B$ . Then for any assignment  $\underline{a}$ ,  $\models A \leftrightarrow B$  implies that  $v(A, \underline{a}) = v(B, \underline{a})$  from theorem 2.6.1. Since the equality means identically the same symbol (the only equality for our language), it follows that  $v(B, \underline{a}) = v(A, \underline{a})$ . Consequently,  $B \equiv A$ .

Now assume that  $A \equiv B$ ,  $B \equiv C$ . Hence,  $\models A \leftrightarrow B$ ,  $\models B \leftrightarrow C$ . Again by application of theorem 2.6.1 and the definition of  $\models$ , it follows that  $\models A \leftrightarrow C$ . Consequently,  $A \equiv C$  and  $\equiv$  is an equivalence relation. ■

We now come to the very important substitution theorem, especially when deduction is concerned. It shows that substitution is allowed throughout the language  $L$  and yields a powerful result.

---

**Definition 2.6.4** (Substitution of formula). Let  $C \in L$  be any formula and  $A$  a formula which is a composite element in  $C$ . Then  $A$  is called a *subformula*. Let  $C_A$  denote the formula  $C$  with the subformula  $A$  specifically identified. Then the substitution process states that if you substitute  $B$  for  $A$  then you obtain the  $C_B$ , where you have substituted for the specific formula  $A$  in  $C$  the formula  $B$ .

---

**Example 2.6.2** Suppose that  $C = (((\neg P) \vee Q) \rightarrow ((P \vee S) \leftrightarrow S))$ . Let  $A = (P \vee S)$  and consider  $C_A$ . Now let  $B = (S \wedge (\neg P))$ . Then  $C_B = (((\neg P) \vee Q) \rightarrow ((\underline{S \wedge (\neg P)}) \leftrightarrow S))$ , where the substituted formula is identified by the underline.

**Theorem 2.6.3** *If  $A, B, C \in L$  and  $A \equiv B$ , then  $C_A \equiv C_B$ .*

Proof. Let  $A \equiv B$ . Then  $\models A \leftrightarrow B$ . Let  $\underline{a}$  be any assignment to the atoms in  $C_A$  and  $C_B$ . Then  $\underline{a}$  may be considered as an assignment for  $C_A, C_B, A, B$ . Let  $\text{size}(C_A) = n$ . In the truth-table calculation process (or formal process) for  $v(C_A, \underline{a})$  there is a step when we (first) calculate  $v(A, \underline{a})$ . Let  $\text{size}(A) = k \leq n$ . If  $\text{size}(A) = n$ , then  $A = C$  and  $C_B = B$  and we have nothing to prove. Assume that  $k < n$ . Then the calculation of  $v(C_A, \underline{a})$  at this specific level only involves the calculation of  $v(A, \underline{a})$  and the other components and other connectives not in  $A$ . The same argument for  $C_B$  shows that calculation for  $C_B$  at this level uses the value  $v(B, \underline{a})$  and any other components and other connectives in  $C$  which are all the same as in  $C_A$ . However, since  $A \equiv B$ , theorem 2.6.1 yields  $v(A, \underline{a}) = v(B, \underline{a})$ . Of course, the truth-values for the other components in  $C_A$  that are the same as the other components in  $C_B$  are equal since these components are the exact same formula. Consequently, since the computation of the truth-value for  $C_A$  and  $C_B$  now continue from this step and all the other connective are the same from this step on, then  $C_A$  and  $C_B$  would have the same truth-value. Hence  $v(C_A, \underline{a}) = v(C_B, \underline{a})$ . But  $\underline{a}$  is arbitrary; hence,  $\models C_A \leftrightarrow C_B$ . Thus  $C_A \equiv C_B$ .

**Corollary 2.6.3.1** *If  $\models A \leftrightarrow B$  and  $\models C_A$ , then  $\models C_B$ .*

Proof. From the above theorem  $\models C_A \leftrightarrow C_B$ , it follows that for any assignment  $\underline{a}$  to the atoms in  $C_A$  and  $C_B$ ,  $v(C_A, \underline{a}) = v(C_B, \underline{a})$ . However,  $v(C_A, \underline{a}) = T$ . Moreover, all of the assignments for the atoms in  $C_A$  and  $C_B$  will yield all of the assignments  $\underline{b}$  for the atoms in  $C_B$  as previously mentioned. Hence, if  $\underline{b}$  is any assignment for the atoms in  $C_B$ , then  $v(C_B, \underline{b}) = T$  and the result follows. ■

[Note: It follows easily that if  $C, A, B$  are written in formula variables and, hence, represent a hidden atomic structure, then Theorem 2.6.3 and its corollary will also hold in this case.]

The next result seems to fit into this section. It's importance cannot be over-emphasized since it mirrors our major rule for deduction. For this reason, it's sometimes called the *semantical modus ponens* result.

**Theorem 2.6.4** *If  $\models A$  and  $\models A \rightarrow B$ , then  $\models B$ .*



Proof. Suppose that  $A, B \in L$ . Let  $\models A$ ,  $\models A \rightarrow B$  and  $\underline{a}$  be any assignment to the atoms in  $A, B$ . Then  $v(A, \underline{a}) = T = v(A \rightarrow B, \underline{a})$ . Thus  $v(B, \underline{a}) = T$ . Since  $\underline{a}$  is any assignment, then, as used previously, using the set of all assignments for  $A, B$ , we also obtain all of the assignments for  $B$ . Hence  $v(B, \underline{b}) = T$  for any assignment for  $B$ 's atoms and the result follows. ■

## EXERCISES 2.6

1. There is a very important property that shows how equivalence relations can carve up a set into important pieces, where each piece contains only equivalent elements. Let  $\equiv$  be *any* equivalence relation defined on the non-empty set  $X$ . This equivalence relation can be used to define a subset of  $X$ . For every  $x \in X$ , this subset is denoted by  $[x]$ . Now to define this very special and important set. For each  $x \in X$ , let  $[x] = \{y \mid y \equiv x\}$ . Thus if you look at one of these sets, say  $[a]$ , and you take any two members, say  $b, c \in [a]$ , it follows that  $b \equiv c$ . Now see if you can establish by a simple logical argument using the properties (i), (ii), (iii) of definition 2.6.2 that:

(A) If there is some  $z \in X$  such that  $z \in [x]$  and  $z \in [y]$ , then  $[x] = [y]$ . (This equality is set equality, which means that  $[x]$  is a subset of  $[y]$  and  $[y]$  is a subset of  $[x]$ .)

(B) If  $x \in X$ , then there exists some  $y \in X$  such that  $x \in [y]$ .

2. (A) Of course, there are usually many interesting binary relations defined on a non-empty set  $X$ . Suppose that you take *any* binary relation  $B$  defined on  $X$  and you emulate the definition we have used for  $[x]$ . Suppose that you let  $(x) = \{y \mid y B x\}$ . Now what if properties (A) and (B) and the reflexive property (i) of definition 2.6.2 hold true for this relation. Try and give a simple argument that shows in this case that  $B$  is, indeed, an equivalence relation.

(B) In (A) of this problem, we required that  $B$  be reflexive. Maybe we can do without this additional requirement. Try and show that this requirement is necessary by looking at a set that contains two and only two elements  $\{a, b\}$  and find a set of ordered pairs, using one or both of its members, that yields a binary relation on  $\{a, b\}$  such that (A) and (B) of problem 1 hold but (i) of definition 2.6.2, the reflexive property, does not hold. If you can find one, this is an absolute counter-example that establishes that the reflexive property is necessary.

3. One of the more important properties of  $\equiv$  is the transitive property (iii). For example, if  $C_A \equiv C_B$  and  $C_B \equiv C_D$ , then  $C_A \equiv C_D$ . Now this can be applied over and over again a finite number of times. Notice what can be done by application of theorem 2.5.3 parts (26) and (31). Suppose that you have a formula  $C$  containing a subformula  $(A \vee B)$ , where  $(A \vee B) \equiv (B \vee A)$  or  $(A \wedge B)$ , where  $(A \wedge B) \equiv (B \wedge A)$ . Letting  $H = (A \vee B)$  and  $K = (B \vee A)$ , then  $C_H \equiv C_K$ . Now recall that, in general, on a set  $X$  where an equality is defined, an operation, say  $\Delta$ , is commutative if for each  $x, y \in X$ , it follows that  $x \Delta y = y \Delta x$ . Thus for the operation and the (not equality) equivalence relation  $\equiv$  the same type of commutative law for  $\vee$  holds. In the following, using if necessary the transitive property, establish that (A), (B), (C), (D) (E) hold by stating the particular valid formula(s) from theorem 2.5.3 that need to be applied.

(A) Given  $C_D$  where  $D = (A \vee (B \vee C))$ , then  $C_D \equiv C_E$ , where  $E = ((A \vee B) \vee C)$ . This would be the *associative law* for  $\vee$ . Now establish the associative law for  $\wedge$ .

(B) Given  $C_H$ , where  $H = (A \vee B)$ . Show that  $C_H \equiv C_K$  where  $K$  only contains the  $\neg$  and  $\rightarrow$  connectives.

(C) Given  $C_H$ , where  $H = (A \wedge B)$ . Show that  $C_H \equiv C_K$  where  $K$  only contains the  $\neg$  and  $\rightarrow$  connectives.

(D) Given  $C_H$ , where  $H = (A \leftrightarrow B)$ . Show that  $C_H \equiv C_K$  where  $K$  only contains the  $\neg$  and  $\rightarrow$  connectives.

(E) Given  $C_H$ , where  $H = (\neg(\neg(\neg \cdots A \cdots)))$ . (i.e. the formula has “n”  $\neg$  to its left.) Show that  $C_H \equiv C_K$  where  $K$  only contains one and only one  $\neg$  or no  $\neg$ .

4. Using the results from problem (3), and using, if necessary a finite number of transitive applications, re-write each of the following formula in terms of an equivalent formula that contains only the  $\neg$  and  $\rightarrow$  connectives. (The formulas are written in the allowed slightly simplified form.)

(a)  $(\neg(A \vee B)) \rightarrow (B \wedge C)$

(c)  $((A \vee B) \vee C) \wedge D.$

(b)  $A \leftrightarrow (B \leftrightarrow C)$

(d)  $\neg((A \vee (\neg B)) \vee (\neg(\neg D)))$

5. In mathematics, it's the usual practice to try and weaken hypotheses as much as possible and still establish the same conclusion. Consider corollary 2.6.3.1. I wonder if this can be weakened to the theorem "if  $\models A \rightarrow B$  and  $\models C_A$ , then  $\models C_B$ ? Try to find an explicit formula such that  $\models A \rightarrow B$  and  $\models C_A$ , but  $\not\models C_B$ . If you can find such a formula in  $L$ , then this would mean that the hypotheses cannot be weakened to  $\models A \rightarrow B$  and  $\models C_A$ .

## 2.7 The Denial, Full Disjunctive Normal Form, Logic Circuits.

*From this point on in this chapter, when we use language symbols such as  $P, Q, R, S, A, B, C, D, E, F$  and the like, it will always be assumed that they are members of  $L$ . This will eliminate repeating this over and over again.*

As was done in the exercises at the end of the last section, checking theorem 2.5.3, we see that  $(A \rightarrow B) \equiv ((\neg A) \vee B)$ . Further,  $(A \leftrightarrow B) \equiv ((A \wedge B) \vee ((\neg A) \wedge (\neg B)))$ . Consequently, for any  $C$ , we can take every subformula that uses connective  $\rightarrow$  and  $\leftrightarrow$ , we can use the substitution process and, hence, express  $C$  in a equivalent form  $D$  where in  $D$  only the connectives  $\neg, \vee$ , and  $\wedge$  appear. Obviously, if  $D$  is so expressed with at most these three connectives, then  $\neg C \equiv \neg D$  and  $\neg D$  is also expressed with at most these three connectives. Further, by use of the valid formula theorem, any formula with more that one  $\neg$  immediately to the left (e.g.  $(\neg(\neg(\neg A)))$ ) is equivalent to either a formula for no  $\neg$  immediately to the left, or at the most just one  $\neg$  immediately on the left. Since  $\neg(A \vee B) \equiv ((\neg A) \wedge (\neg B))$  and  $\neg(A \wedge B) \equiv ((\neg A) \vee (\neg B))$  then, applying the above equivalences, we can express any formula  $C$  in an equivalent form  $D$  with the following properties.

- (i)  $D$  is expressed entirely in atoms.
- (ii) Every connective in  $D$  is either  $\neg, \vee, \wedge$ .
- (iii) And, when they appear, only single  $\neg$ 's appear immediately to the left of atoms.

**Definition 2.7.1** (The denial.) Suppose that  $A$  is in the form  $D$  with properties (i), (ii), (iii) above. Then the *denial*  $A_d$  of  $A$  is the formula obtained by

- (a) dropping the  $\neg$  that appears before any atom.
- (b) Placing a  $\neg$  before any atom that did not have such a connective immediately to the left.
- (c) Replacing each  $\vee$  with  $\wedge$ .
- (d) Replacing each  $\wedge$  with  $\vee$ .
- (e) Adjust the parentheses to make a correct language formula.

**Example 2.7.1** Let  $A = ((\neg P) \vee (\neg Q)) \wedge (R \wedge (\neg S))$ . Then  $A_d = (P \wedge Q) \vee ((\neg R) \vee S)$ . Notice were the parentheses have been removed and added in this example.

**Theorem 2.7.1** Let  $A$  be a formula containing only atoms, the connective  $\neg$  appearing only to the immediate left of atoms, if at all, and any other connectives are  $\wedge$  and/or  $\vee$ . Then  $\neg A \equiv A_d$ .

Proof. (This is the sort of thing where mathematicians seem to be proving the obvious since we have demonstrated a way to create the equivalent formula. The proof is a formalization of this process for ANY formula based upon one of the most empirically consistent processes known to the mathematical community. The process is called induction on the natural numbers, in this case the unique natural number we call the size of a formula.)

First, we must show the theorem holds true for a formula of size 0. So, let  $\text{size}(A) = 0$ . Then  $A = P \in L_0$  and is a single atom. Then  $A_d = \neg A$ . Further,  $\neg A = \neg P$ . We know that for any formula  $D$ ,  $D \equiv D$ . Hence,  $\neg A \equiv A_d$  for this case.

Now (strong) induction proofs are usually done by assuming that the theorem holds for all  $A$  such that  $\text{size}(A) \leq n$ , where  $n > 0$ . Then using this last statement, it is shown that one method will yield the theorem's conclusions for  $\text{size}(A) = n + 1$ . However, this specific procedure may not work, yet, since there is not one simple method unless we start at  $n > 1$ . Thus let  $\text{size}(A) = 1$ . Then there are three possible forms. (i) Let  $A = \neg P$ . Then, from theorem 2.5.3, it follows that  $\neg A = \neg(\neg P) \equiv P$ . Now notice that if  $A = B$ , then  $\models A \leftrightarrow B$ . Further,  $A_d = P$  implies that  $\neg A \equiv A_d$ . For the cases where  $A = P \wedge Q$  or  $A = P \vee Q$ , the result follows from theorem 2.5.3, parts (38), (39).

Now assume that the theorem holds for a formula  $A$  of size  $r$  such that  $1 \leq r \leq n$ . Let  $\text{size}(A) = n + 1$ . Also we make the following observation. Because of the structure of the formula  $A$ ,  $A$  cannot be of the form  $\neg B$  where  $\text{size}(B) \geq 1$ . Indeed, if the formula has a  $\neg$  and a  $\vee$  or an  $\wedge$ , then  $\text{size}(A) > 1$ . Consequently, there will always be two and only two cases.

Case (a). Let  $A = B \vee C$ . Consider  $\neg A = \neg(B \vee C)$ . From the above discussion, observe that  $\text{size}(\neg B) \leq n$ . Hence, by the induction hypothesis,  $\neg B \equiv B_d$  and, in like manner,  $\neg C \equiv C_d$ . Theorem 2.5.3, shows that  $\neg(B \vee C) \equiv (\neg B) \wedge (\neg C)$ . Since equal formula are equivalent, then substitution yields,  $\neg(A \vee C) \equiv B_d \wedge C_d$ . Again, since  $A_d = B_d \wedge C_d$ , and equal formula are equivalent, substitution yields  $\neg A \equiv A_d$ .

Case (b). Let  $A = B \wedge C$ . This follows as in case (a) from theorem 2.5.3. Thus the theorem holds for  $\text{size}(A) = n + 1$ . From the induction principle, the theorem holds for any (specially) constructed formula since every such formula has a unique size which is a natural number. ■

On page 28, I mentioned how you could take certain valid formula and find a correct set-theoretic formula. The same can be done with the denial of the special form  $A$ . If you have any knowledge in this area, the  $\neg$  is interpreted as set-complementation with respect to the universe. We can get another one of D'Morgan's Laws, for complementation using  $\neg A \equiv A_d$ .

Since any formula is equivalent, by theorem 2.5.3 part (29), to infinitely many different formula, it might seem not to intelligent to ask whether or not a member of  $L$  is equivalent to a formula that is unique in some special way? Even if this is true, is this uniqueness useful? So, the basic problem is to define the concept of a *unique equivalent form* for any give formula.

Well, suppose that  $A$  is a contradiction and  $P$  is any atom. Then  $A \equiv (P \wedge (\neg P))$ . And if  $B$  is any valid formula, then  $B \equiv (P \vee (\neg P))$ . Hence, maybe the concept of a unique equivalent form is not so easily answered. But, we try anyway.

Let  $A$  be a formula that is in atomic form and contains only the atoms  $P_1, \dots, P_n$ . We show that there is a formula equivalent to  $A$  that uses these are only these atoms and that does have an *almost* unique form. The formula we construct is called the **full disjunctive normal form** and rather than put this into a big definition, I'll slowly described the process by the truth-table procedure.

Let the distinct atoms  $P_1, \dots, P_n$  be at the top of a truth-table and in the first "n" columns. Now observe that when we calculate the truth-values for a formula  $A \wedge (B \wedge C)$  we have also calculated the truth-values for the formula  $(A \wedge B) \wedge C$  since not only are these formula equivalent, but they use the same formula  $A$ ,  $B$ ,  $C$ , the exact same number and type of connective, in the exact same places. Indeed, only the parentheses are in different places. For this reason, we often *drop the parentheses in this case* when we are calculating the truth value for  $A \wedge (B \wedge C)$ . Now for the procedure. Consider any row  $k$ , where  $1 \leq k \leq 2^n$ .

- (a) For each  $T$  that appears in that row under the atom  $P_i$ , write done the symbol  $P_i$ .
- (b) For each  $F$  that appears in that row under the atom  $P_j$ , write done the symbol  $(\neg P_j)$ .

(c) Continue this process until you have used (once) each truth value that appears in row  $k$  making sure you have written down all these symbols in a single row and have left spaces between them.

(d) If there is more than one symbol, then between each symbol put a  $\wedge$  and insert the outer most parentheses.

(e) The result obtained is called the **fundamental conjunction**.

**Example 2.7.2** Suppose that the  $k$ th row of our truth table looks like

$P_1$	$P_2$	$P_3$
$T$	$F$	$F$

Then, applying (a), (b), (c), we write down

$$P_1 \quad (\neg P_2) \quad (\neg P_3)$$

Next we do as we are told in (d). This yields

$$(P_1 \wedge (\neg P_2) \wedge (\neg P_3)).$$

Now the assignment for the  $k$  row is  $\underline{a} = (T, F, F)$ . Notice the important fact that  $v((P_1 \wedge (\neg P_2) \wedge (\neg P_3)), \underline{a}) = T$ . What we have done to remove any possibility that the truth-value would be  $F$ . But, also it's significant, that if we took any other *distinctly different* assignment  $\underline{b}$ , then  $v((P_1 \wedge (\neg P_2) \wedge (\neg P_3)), \underline{b}) = F$ . These observed facts about this one example can be generally established.

**Theorem 2.7.2** Let  $k$  be any row of a truth-table for the distinct set of atoms  $P_1, \dots, P_n$ . Let  $\underline{a}$  be the assignment that this row represents. For each  $a_i = T$ , write down  $P_i$ . For each  $a_j = F$ , write down  $(\neg P_j)$ . Let  $A$  be the formula obtained by placing conjunctions between each pair of formula if there exists more than one such formula. Then  $v(A, \underline{a}) = T$ , and for any other distinct assignment  $\underline{b}$ ,  $v(A, \underline{b}) = F$ .

Proof. See theorems 1.6 and 1.7 on pages 13, 14 of the text "Boolean Algebras and Switching Circuits," by Elliott Mendelson, Schaum's Outline Series, McGraw Hill, 1970.

Now for any formula  $C$  composed of atoms  $P_1, \dots, P_m$  and which is *not a contradiction* there will be, at the least, one row assignment  $\underline{a}$  such that  $v(C, \underline{a}) = T$ . We now construct the formula that is equivalent to  $C$  that we has an almost unique form.

**Definition 2.7.1** (Full disjunctive normal form.) Let  $C$  not be a contradiction.

(a) Take every row  $k$  for which  $v(C, \underline{a}) = T$ .

(b) Construct the fundamental conjunction for each such row.

(c) Write down all such fundamental conjunctions and between each pair, if any, place a  $\vee$ .

(d) The result of the construction (a), (b), (c) is called the **full disjunctive normal form** for  $C$ . This can be denoted by  $\text{fdnf}(C)$ .

**Example 2.7.2** Suppose that  $C = P \leftrightarrow (Q \vee R)$ . Now consider the truth-table.

$P$	$Q$	$R$	$C$
$T$	$T$	$T$	$T$
$T$	$T$	$F$	$T$
$T$	$F$	$T$	$T$
$T$	$F$	$F$	$F$
$F$	$T$	$T$	$F$
$F$	$T$	$F$	$F$
$F$	$F$	$T$	$F$
$F$	$F$	$F$	$T$

Now we construct fundamental conjunctions for rows 1, 2, 3, 8. This yields  $(P \wedge Q \wedge R)$ ,  $(P \wedge Q \wedge (\neg R))$ ,  $(P \wedge (\neg Q) \wedge R)$ ,  $((\neg P) \wedge (\neg Q) \wedge (\neg R))$ . Notice that I have not included for the  $\wedge$  the internal parentheses since they can be placed about any two expressions.

Then putting these together we have

$$\text{fdnf}(C) = (P \wedge Q \wedge R) \vee (P \wedge Q \wedge (\neg R)) \vee (P \wedge (\neg Q) \wedge R) \vee ((\neg P) \wedge (\neg Q) \wedge (\neg R)).$$

**Theorem 2.7.3** *Let non-contradiction  $C \in L$ . Then  $\text{fdnf}(C) \equiv C$ .*

Proof. See the reference given in the proof of theorem 2.7.2. ■

The is no example 2.7.3. The fdnf is unique in the following sense.

**Theorem 2.7.4.** *If formula  $B$ ,  $C$  have the same number of atoms which we can always denote by the same symbols  $P_1, \dots, P_m$ . If  $\text{fdnf}(B)$  and  $\text{fdnf}(C)$  have the same set of fundamental conjunctions except for a change in order of the individual conjuncts, then  $\text{fdnf}(B) \equiv \text{fdnf}(C)$ .*

Proof. I'm sure you could prove this from our validity theorem, substitution, and the properties of  $\equiv$ . ■

Usually, when elementary concepts in logic are investigated, the subject of computers is often of interest. The reason for this is that, technically, computers perform only a very few basic underlying processes all related to propositional logic. So, for a moment, let's look at some of the basic *logic circuits*, many of which you can construct. Such circuits are extensions of the (switching) relay circuits where we simply suppress the actual device the functions in the fashion diagrammed on pages 17, 18. Since any formula  $A$  is equivalent to its fdnf, its the fdnf that's used as a bases for these elementary logic circuits. An important procedure within complex logic circuits is simplification or minimizing techniques. Simplification does not necessarily mean fewer devices. The term simplification includes the concept of something being more easily constructed and/or less expensive. We will have not interest is such simplification processes.

Looking back at pages 17, we have three logic devices. The *or-gate*  $\vee$ , diagram (i); the *and-gate*  $\wedge$ , diagram (ii), and an *inverter*  $\neg$ , which is the combination of the two diagrams above diagram (i). The inverter behaves as follows: when current goes in one end, it opens and no current leaves the exit wire, the output. But, when input is no current, then output is current. (We need not use current, of course. Any two valued physical event can be used.) In the following diagrams the current direction and what is called

the *logical flow* is indicated by the line with an arrow. If there is no flow, then no arrows appear. Now each gate has at least two inputs and one output in our diagrams except the inverter.

It's very, very easy to understand the behavior of the or-gates and the and-gates. They have the same current flow properties as a corresponding truth-table, where *T* means current flows and *F* means no current flows. The basic theorem used for all logic circuits is below.

**Theorem 2.7.5** *If  $A \equiv B$ , then any logic circuit that corresponds to  $A$  can be substituted for any logical circuit that corresponds to  $B$ .*

Proof. Left to you.

**Example 2.7.4** Below are diagrams for two logic circuits. For the first circuit, note that if no circuit flows into lines *A* and *B*, then there is a current flowing out the *C* line. In current flows in the *A* and *B* line from left to right, then again current flows out the *C* line. But if current flows in the *A* and not in the *B*, or in the *B* and not in the *A*, then no current flows out the *C* line. I'll let you do the "flow" analyze for the second diagram.

In the first diagram, the symbol  $\searrow_x$  means that the arrow has been removed from the pathway indicator. (This is done to minimize the storage space required when processing this monograph.) The diagrams only show what happens when both *A* and *B* have current.

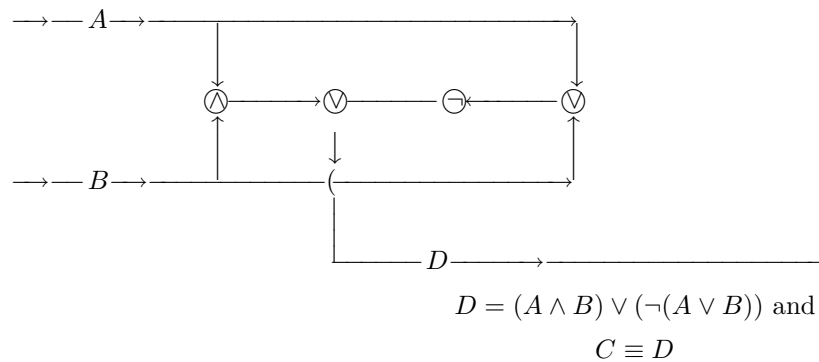
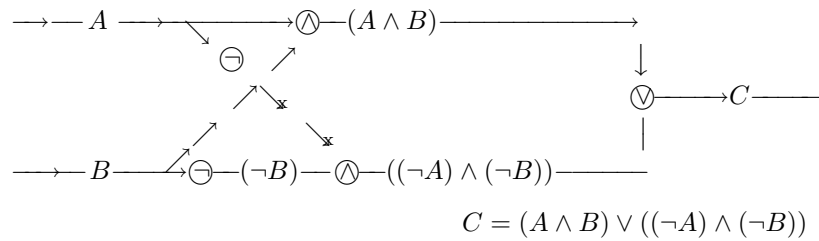

An important aspect of logic circuits is that they can be so constructed so that they will do binary arithmetic. Here is an example of binary arithmetic.

$$\begin{array}{r} 01 \\ +11 \\ \hline 100 \end{array}$$

The process goes like this. First  $1 + 1 = 10$ . Thus you get a  $0 = S$  with a carry over digit  $= 1 = C$ . The carry over digit is then added to the next column digit  $1$  and you get  $10$ , which is a  $0$  with a carry over of  $1$ . The following logic circuit does a part of this arithmetic. If current in *A*, *B* indicates  $1$ , no current indicates  $0$ . This represents the first step and yields the basic *S* and the basic cover number *C*. (Insert Figure 2 below.)

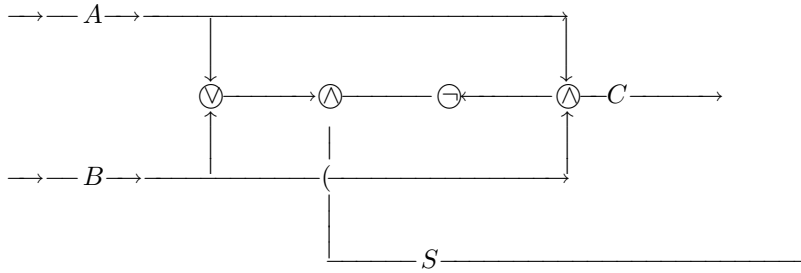

### EXERCISES 2.7

1. Express each of the following formula as an equivalent formula in terms of, at the most, one  $\neg$  on the left of an atom, and the connectives  $\vee$  or  $\wedge$ .

- |  |  |
|--|--|
| (a) $P \leftrightarrow (A \rightarrow (R \vee S))$ | (d) $((\neg P) \leftrightarrow Q) \rightarrow R$ |
| (b) $((\neg P) \rightarrow Q) \leftrightarrow R$   | (e) $(S \vee Q) \rightarrow R$                   |
| (c) $(\neg((\neg P) \vee (\neg Q))) \rightarrow R$ | (f) $(P \vee (Q \wedge S)) \rightarrow R$        |

2. Write the denial for each of the following formula.

- |  |  |
|--|--|
| (a) $((\neg P) \vee Q) \wedge (((\neg Q) \vee P) \wedge R)$        | (c) $((\neg R) \vee (\neg P)) \wedge (Q \wedge P)$                 |
| (b) $((P \vee (\neg Q)) \vee R) \wedge ((\neg P) \vee Q) \wedge R$ | (d) $((Q \wedge (\neg R)) \vee Q) \vee (\neg P) \wedge (Q \vee R)$ |

3. Write each of the following formula in its fdnf, if it has one.

- |   |   |
|---|---|
| (a) $(P \wedge (\neg Q)) \vee (P \wedge R)$ | (c) $(P \vee Q) \leftrightarrow (\neg R)$   |
| (b) $P \rightarrow (Q \vee (\neg R))$       | (d) $(P \rightarrow Q) \rightarrow ((Q \rightarrow R) \rightarrow (P \rightarrow R))$ |

4. Using only inverters, or-gates and and-gates, diagram the logic circuits for the following formula. Notice that you have three inputs.

- |   |                                       |
|---|---------------------------------------|
| (a) $(A \vee (\neg B)) \vee (B \wedge (C \vee (\neg A)))$ | (b) $(A \rightarrow B) \vee (\neg C)$ |
|---|---------------------------------------|

5. The following two diagrams correspond to an output which is a composite formula in terms of  $A$ ,  $B$ ,  $C$ . Write down this formula.

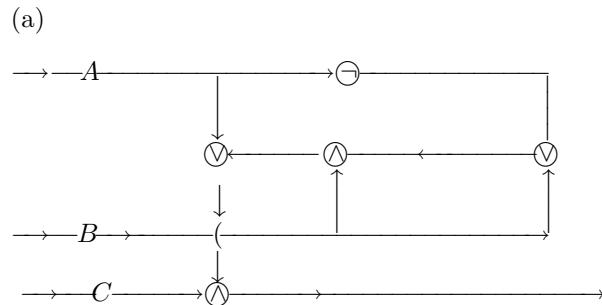

(b)

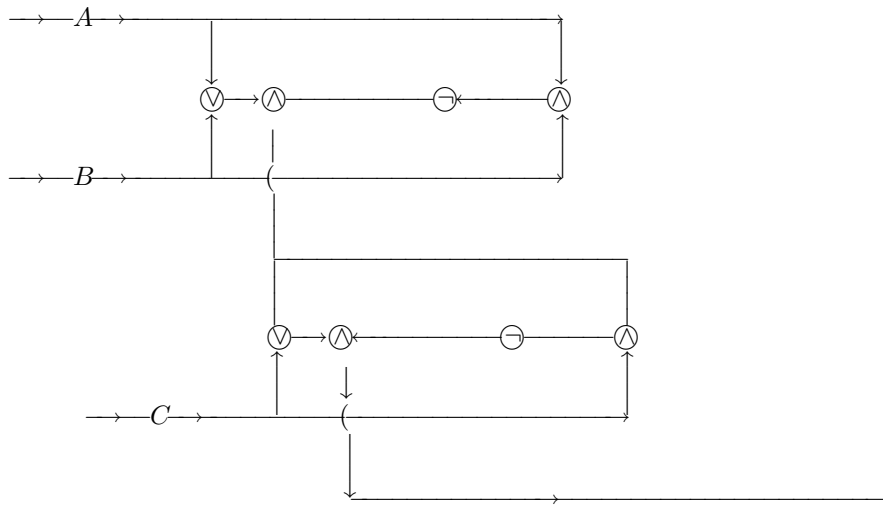

---

---

## 2.8 The Princeton Project, Valid Consequences (in General).

After the methods were discovered that use logical operators to generate a solution to the General Grand Unification Problem, and that give an answer to the questions “How did our universe come into being?” and “Of what is empty space composed?” I discovered that the last two questions were attacked, in February — April 1974, by John Wheeler and other members of the Physics and Mathematics Department at Princeton University. Wheeler and Patton write, “It is difficult to imagine a simpler element with which the construction of physics might begin than the choice yes–no or true–false or open circuit–closed circuit. . . . which is isomorphic [same as] a proposition in the propositional calculus of mathematical logic.” [Patton and Wheeler, *Is Physics Legislated by a Cosmogony*, in *Quantum Gravity*, ed. Isham, Penrose, Sciama, Oxford University Press, Oxford (1975), pp. 538–605.] These basic concepts are exactly what we have just studied.

These individuals, one of the world’s foremost group of scientists, attempted to solve this problem by a statistical process, but failed to do so. Because they failed, they rejected any similar approach to the problem. They seemed to be saying that “If we can’t solve these problems, then no one can.” They were wrong in their rejection of the propositional calculus as a useful aspect for such a solution. But, the solution does not lay with this two valued truth–falsity model for the propositional logic. The solution lies with the complementary aspect we’ll study in section 2.11 called *proof theory*. Certain proof theory concepts correspond to simple aspects of our truth–falsity model. In particular, we are able to determine by assignment and truth-table procedures whether or not a logical argument is following basic human reasoning processes (i.e. classical propositional deduction). However, what you are about to study will not specifically identify what the brain is doing, but it will determine whether or not it has done its deduction in terms of the classical processes must easily comprehend by normal human beings.

Let  $\{A_1, \dots, A_n\}$  be a finite (possibly empty) set of formula. These formula represent the *hypotheses* or *premises* for a logical argument. For convenience, it has become common place to drop the set-theoretic notation  $\{$  and  $\}$  from this notation. Since these are members of a set, they are all distinct in form. Again from the concepts of set-theory, these formula are not considered as “ordered” by the ordering of the subscripts.



---

**Definition 2.8.1** (Valid consequence.) A formula  $B$  is a *valid consequence* (or simply a consequence) of a set of premises  $A_1, \dots, A_n$  if for any assignment  $\underline{a}$  to the atoms in each  $A_1, \dots, A_n$  AND  $B$  such that  $v(A_1, \underline{a}) = \dots = v(A_n, \underline{a}) = T$ , then  $v(B, \underline{a}) = T$ . If  $B$  is a valid consequence of  $A_1, \dots, A_n$ , then this is denoted by  $A_1, \dots, A_n \models B$ .

---

As usual, if some part of definition 2.8.1 does not hold, then  $B$  is an invalid (not a valid) consequence of  $A_1, \dots, A_n$ . This is denoted by  $A_1, \dots, A_n \not\models B$ . It is important to notice that definition 2.8.1 is a conditional statement. This leads to a very interesting result.

**Theorem 2.8.1** Let  $A_1, \dots, A_n$  be a set of premises and there does not exist an assignment to the atoms in  $A_1, \dots, A_n$ , such that the truth-values  $v(A_i, \underline{a}) = T$  for each  $i$ , where  $1 \leq i \leq n$ . Then, for ANY formula  $B \in L$ ,  $A_1, \dots, A_n \models B$ .

Proof. In a true conditional statement, if the hypothesis is false, then the conclusion holds. ■

The conclusion of theorem 2.8.1 is so significant that I'll devote an entire section (2.10) to a more in-depth discussion. Let's continue with more facts about the valid consequence concept. We will need two terms, however, for the work in this section that are also significant for section 2.10.

---

**Definition 2.8.2** (Satisfaction.) If given a set of formula  $A_1, \dots, A_n$  ( $n \geq 1$ ), there exists an assignment  $\underline{a}$  to all the atoms in  $A_1, \dots, A_n$  such that  $v(A_1, \underline{a}) = \dots = v(A_n, \underline{a}) = T$ , then the set of premises are said to be *satisfiable*. The assignment itself is said to *satisfy* the premises. One the other hand, if such an assignment does not exist, then the premises are said to be *not satisfied*.

---

**Theorem 2.8.2** (Substitution of equivalence.) If  $A_n \equiv C$  and  $A_1, \dots, A_n \models B$ , then  $A_1, \dots, A_{n-1}, C \models B$ . If  $B \equiv C$  and  $A_1, \dots, A_n \models B$ , then  $A_1, \dots, A_n \models C$ .

Proof. Left to you. ■

Are many logical arguments that seem very complex, in reality, a disguised simple deduction? Conversely, can we take a simple deduction and make it look a little more complex? The following theorem is not the last word on this subject and is very closely connected with what we mean when we say that such and such is a set of premises. When we write the premises  $A_1, \dots, A_n$ , don't we sometime (all the time?) say "and" when we write the comma ","? Is this correct?

**Theorem 2.8.3** (The Deduction Theorem) Let  $\Gamma$  be any finite (possible empty) set of formula and  $A, B \in L$ .

(i)  $\Gamma, A \models B$  if and only if  $\Gamma \models A \rightarrow B$ .

(ii) Let  $A_1, \dots, A_i, \dots, A_n$  be a finite (nonempty) set of formula, where  $1 < i \leq n$ . Then  $A_1, \dots, A_n \models B$  if and only if  $A_1, \dots, A_i \models (A_{i+1} \rightarrow (\dots \rightarrow (A_n \rightarrow B) \dots))$ .

(iii) Let  $A_1, \dots, A_i, \dots, A_n$  be a finite (nonempty) set of formula, where  $1 < i \leq n$ . Then  $A_1, \dots, A_n \models B$  if and only if  $(A_1 \wedge \dots \wedge A_i), \dots, A_n \models B$ .

(iv)  $A_1, \dots, A_n \models B$  if and only if  $\models (A_1 \wedge \dots \wedge A_n) \rightarrow B$ .

Proof. (i) Assume that  $\Gamma, A \models B$ . Let  $\underline{a}$  be an assignment to the set of atoms in  $\Gamma, A, B$ . If  $\underline{a}$  satisfies  $\Gamma, A$ , then  $v(A, \underline{a}) = T$ . Also from the hypothesis,  $v(B, \underline{a}) = T$ . Hence,  $v(A \rightarrow B, \underline{a}) = T$ . Now if  $\Gamma$  is not satisfied (whether or not  $A$  is), then from theorem 2.8.1,  $\Gamma \models A \rightarrow B$ . If  $\underline{a}$  satisfies  $\Gamma$  and does not satisfy  $A$ , then  $v(A, \underline{a}) = F$ . Thus,  $v(A \rightarrow B, \underline{a}) = T$ . All the cases have been covered; hence, in general,  $\Gamma \models A \rightarrow B$ .

Conversely, assume that  $\Gamma \models A \rightarrow B$  and let  $\underline{a}$  be as previous defined. If  $\underline{a}$  does not satisfy  $\Gamma$ , then  $\underline{a}$  does not satisfy  $\Gamma, A$ . If  $\underline{a}$  satisfies  $\Gamma$  and does not satisfy  $A$ , then  $\underline{a}$  does not satisfy  $\Gamma, A$ . Hence, we only

need to consider what happens if  $\underline{a}$  satisfies  $\Gamma, A$ . Then, in this case,  $v(A, \underline{a}) = T$ . Since  $v(A \rightarrow B, \underline{a}) = T$ , then  $v(B, \underline{a}) = T$ . Therefore,  $\Gamma, A \models B$ .

(ii) (By induction on the number  $m$  of connectives  $\rightarrow$  placed between the formula on the right of  $\models$ .)

(a) The  $m = 1$  case is but part (i). Assume theorem holds for  $m$  connectives. Then one more applications of (i) shows it holds for  $m + 1$  connectives  $\rightarrow$ . Hence, the result holds in general. Similarly the converse holds.

(iii) (By induction on the  $m$  number of connectives  $\wedge$  placed between  $A_1, \dots, A_i$ .) Suppose that  $A_1, A_2, \dots, A_n \models B$ .

(a) Let  $m = 1$ . Suppose that  $A_1, A_2, \dots, A_n \models B$ . Let  $\underline{a}$  be an assignment to all the atoms in  $(A_1 \wedge A_2), \dots, A_n, B$  that satisfies  $(A_1 \wedge A_2), \dots, A_n$ . Then  $v(A_1 \wedge A_2, \underline{a}) = T$ . Hence,  $v(A_1, \underline{a}) = v(A_2, \underline{a}) = T$ . Then  $\underline{a}$  is an assignment to all the atoms in  $A_1, A_2, \dots, A_n, B$ . Now  $v(A_1, \underline{a}) = v(A_2, \underline{a}) = T = \dots = v(A_n, \underline{a})$ . This implies that  $v(B, \underline{a}) = T$ . Hence,  $(A_1 \wedge A_2), \dots, A_n \models B$ .

(b) Now assume theorem holds for  $m$  or less connectives  $\wedge$  and suppose that  $i = m + 2$ . We know that  $A_1, A_2, \dots, A_i, \dots, A_n \models B$ . Now from (ii), we know that  $A_1, A_2, \dots, A_{m+1} \models (A_{m+2} \rightarrow (\dots (A_n \rightarrow B) \dots))$  from (ii). The induction hypothesis yields  $(A_1 \wedge A_2 \wedge \dots \wedge A_{m+1}) \models (A_{m+2} \rightarrow (\dots (A_n \rightarrow B) \dots))$ . From this we have  $(A_1 \wedge A_2 \wedge \dots \wedge A_{m+1}), A_{m+2} \models (A_{m+3} \rightarrow (\dots (A_n \rightarrow B) \dots))$ . Application of (i) and (ii) yields  $(A_1 \wedge \dots \wedge A_{m+2}), \dots, A_n \models B$ . The general result follows by induction and the converse follows in a similar manner.

(iv) Obvious from the other results. ■

When you argue logically for a conclusion, it's rather obvious that one of your hypotheses is a valid conclusion. Further, if you start with a specific set of hypotheses and obtained a finite set of logical conclusions. You then often use these conclusions to argue for other consequences. Surely it should be possible to go back to your original hypotheses and argue to you final conclusions without going through the intermediate process.

#### Theorem 2.8.4

(i)  $A_1, \dots, A_n \models A_i$  for each  $i = 1, \dots, n$ .

(ii) If  $A_1, \dots, A_n \models B_j$ , where  $j = 1, \dots, p$ , and  $B_1, \dots, B_p \models C$ , then  $A_1, \dots, A_n \models C$ .

Proof. (i) Let  $\underline{a}$  be any assignment that satisfies  $A_1, \dots, A_n$ . Hence,  $v(A_i, \underline{a}) = T$ , for each  $i = 1, \dots, n$ . Thus  $A_1, \dots, A_n \models A_i$  for each  $i = 1, \dots, n$ .

(ii) Let  $\underline{a}$  be an assignment to all the atoms in  $A_1, \dots, A_n, B_i, \dots, B_p, C$ . Of course, this is also an assignment for each member of this set. Conversely, any assignment to any of the formula in this set can be extended to an assignment to all the atoms in this set. Suppose that  $v(A_i, \underline{a}) = T$ , for each  $i$  such that  $1 \leq i \leq m$ . Since  $A_1, \dots, A_n \models B_j$ , where  $j = 1, \dots, p$ , then  $v(B_j, \underline{a}) = T$ , where  $j = 1, \dots, p$ . This  $\underline{a}$  satisfies  $B_j$  for each  $j = 1, \dots, p$ . Hence, from the remainder of the hypothesis,  $v(C, \underline{a}) = T$  and the proof is complete. ■

[For those who might be interested. This is not part of the course. First, we know that if  $A \equiv B$ , then we can substitute throughout the process  $\models$  anywhere  $A$  for  $B$  or  $B$  for  $A$ . Because of theorem 2.8.3, all valid consequences can be written as  $A \models B$ , where  $A$  is just one formula. (i) Now  $A \models A$ , and (ii) if  $A \models B, B \models C$ , then  $A \models C$ . Thus  $\models$  behaves almost like the partial ordering of the real numbers. If you substitute  $\leq$  for  $\models$  you have  $A \leq A$ , if  $A \leq B, B \leq C$ , then  $A \leq C$ . In its present form it does not have the requirement that (iii) if  $A \leq B, B \leq A$ , then  $A = B$ . However, notice that if  $A \models B, B \models A$ , then  $\models A \rightarrow B, \models B \rightarrow A$ . This implies that  $A \equiv B$ . Hence we could create a language by taking one and only

one member of from each equivalence class [A] (see problem 1, Exercise 2.6.) and only used these for logical deduction. (A very boring way to communicate.) Then (iii) would hold. Hence, in this case, everything known about a partial ordering should hold for the  $\models$  .]

### EXERCISE 2.8

1. First, note the discussion at the top of page 57 as to how to use truth-tables to determine if a consequence is valid. Now use the truth-table method to determine whether the following consequences are valid consequences from the set of premises.

(a)  $P \rightarrow Q, (\neg P) \rightarrow Q \models Q$ .

(b)  $P \rightarrow Q, Q \rightarrow R, P \models R$ .

(c)  $(P \rightarrow Q) \rightarrow P, \neg P \models R$ .

(d)  $(\neg P) \rightarrow (\neg Q), P \models Q$ .

(e)  $(\neg P) \rightarrow (\neg Q), Q \models P$ .

### 2.9 Valid Consequences — Model Theory and Beyond.

The most obvious way to show that  $B$  is a valid consequence of  $A_1, \dots, A_n$  is by the truth-table method.

(i) Simply set up a truth-table for the formulas  $A_1, \dots, A_n, B$ .

(ii) Look at every row, where under each  $A_i$  there is a  $T$ , and if in that row the  $B$  is a  $T$ , then  $B$  is a valid consequence of  $A_1, \dots, A_n$ .

Of course, if  $A_1, \dots, A_n$  is not satisfiable, then it is automatically the case that  $B$  is a valid consequence. BUT, in most cases you would have a very large truth-table. For example, for the arguments of section 1.1, you would need a truth-table with  $2^6 + 1 = 65$  rows and about 8 columns. You might get a research grant, of some sort, so that you could get the materials for such a truth-table construction. This is the strict *model theory* approach. Why? Because the truth-table is a “model” (i. e. not the real thing) for classical human propositional deduction. When I deduce what I hope is a logical conclusion, I don’t believe I construct a truth-table in my mind. Maybe some do, but I don’t. So, is there another method that is model theory viewed in a different way that may be a shorter method? The method comes from theorem 2.8.3 part (iv).

**NOTATION CHANGE.** It seems pointless to keep saying “Let  $\underline{a}$  be an assignment to the atoms in  $A$ . Then  $v(A, \underline{a}) = T$  or  $F$ .” Why not do the following: just write  $v(A, \underline{a}) = v(A) = T$ . When we see  $v(A) = T$  or  $F$ , we know that there is some assignment to the atoms that makes it so.

Now what theorem 2.8.3 tells us is that all we need to do is to show that  $\models (A_1 \wedge \dots \wedge A_n) \rightarrow B$ . But, if one selects an assignment such that  $v(B) = F$ , then  $\models (A_1 \wedge \dots \wedge A_n) \rightarrow B$  if and only if  $v((A_1 \wedge \dots \wedge A_n)) = F$ . We need not look at the case when  $v(B) = T$ . (Why not ?) The method is a natural language algorithm. This means that I use some of the terms that I’ve previously introduced and ordinary English to give a series of repeatable instructions. Now whether or not this method is shorter than the truth-table method depends upon how clever you are in a certain selection process. Only experience indicates that it is often much shorter. The instructions themselves are not short in content. But remember these methods took over 2,000 years to develop.

**Special Method 2.9.1** (To show that  $\models (A_1 \wedge \dots \wedge A_n) \rightarrow B$ .) In what follows, the symbol  $\Rightarrow$  represents that word *forces*.

(1) First, let  $v(B) = F$ . In the simplest case, this truth-value for  $B \Rightarrow$  a fixed truth-value on each of the atoms of  $B$ . Let these atoms have these forced truth-values.

**Example 2.9.1.1** Let  $B = P \rightarrow (Q \rightarrow R)$ . Then  $v((P \rightarrow (Q \rightarrow R))) = F \Rightarrow v(P) = T; v(Q) = T; v(R) = F$  and these are the only possibilities.

(2) See if these forced and fixed atom truth-values forces any of the premises to have a fixed truth-value.

(3) If (2) occurs and the value of the premise is  $F$ , then the process stops and you have a **valid** consequence.

**Example 2.9.1.2** Suppose that one of the premises is  $A = P \wedge R$ . Then for example 2.9.1.1 atomic values you would have that  $v(A) = F$ . You can stop the entire process.  $B$  is an valid consequence of the premises.

(4) If (2) occurs and the truth-value is  $T$  for a premise, then simply write it down as its value.

(5) If (4) occurs and there are more premises that are NOT forced to take on a specific truth value by the forced atomic truth-values for  $B$ , then you can select any of the remaining premises, usually those with the fewest non-forced atoms (but not always), and set the truth value of the selected premise as  $T$ .

**Example 2.9.1.3** Suppose that process did not stop at step (3). Let one of the premises be  $A_1 = S \vee R$ . Then setting  $v(A_1) = T \Rightarrow v(S) = T$ .

(6) You now have some premises with forced or selected values of  $T$ . Now use the forced atomic values and begin again with (2) for the remaining process.

(7) If this the simplest part of the process stops, then it will either force a premise to be  $F$  and you may stop and declare the consequence valid or all the premises will be selected or forced to be  $T$  and you have found one assignment that proves that the consequence is **invalid**.

**Example 2.9.1.4** Suppose that you what to answer the question  $P_1 \rightarrow (P_2 \rightarrow P_3), (P_3 \wedge P_4) \rightarrow P_5, (\neg P_6) \rightarrow (P_4 \wedge (\neg P_5)) \stackrel{?}{\models} P_1 \rightarrow (P_2 \rightarrow P_6)$ .

(i) Well, let  $v(P_1 \rightarrow (P_2 \rightarrow P_6)) = F$ . Then  $v(P_1) = v(P_2) = T, v(P_6) = F$ . These values do not force any of the premises to be any fixed value.

(ii) Select the first premise and let  $v(P_1 \rightarrow (P_2 \rightarrow P_3)) = T$ . From (i)  $\Rightarrow v(P_3) = T$ . The values that have been forced do not force the remaining premises to take any fixed value.

(iii) Let  $v((\neg P_6) \rightarrow (P_4 \wedge (\neg P_5))) = T \Rightarrow v(P_4 \wedge (\neg P_5)) = T$  from (1). Hence  $v(P_4) = T, v(P_5) = F$ . But these forced atoms  $\Rightarrow v((P_3 \wedge P_4) \rightarrow P_5) = F$ .

(iv) Hence,  $\models$  holds. Notice that for this example a truth table requires 65 rows.

**Example 2.9.1.4** Suppose that you what to answer the question  $P \rightarrow R, Q \rightarrow S, (\neg R) \vee (\neg S) \stackrel{?}{\models} P \vee (\neg Q)$ .

(i) Let  $v(P \vee (\neg Q)) = F, \Rightarrow v(P) = F, v(Q) = T$ .

(ii) Let  $v(Q \rightarrow S) = T$ , from (i),  $\Rightarrow v(S) = T$ .

(iii) Let  $v((\neg R) \vee (\neg S)) = T$ , from (ii),  $\Rightarrow v(R) = F$ .

(iv) Now (i) and (iii)  $\Rightarrow v(P \rightarrow R) = T$ .

(v) Since all premises were either selected or forced to be  $T$ , then  $B$  is an invalid consequence from the premises.

Is all of this important? Well, suppose that you were given a set of orders by your commanding officer. You tried to follow these orders but could not do so. Why can't they be carried out? You discover, after a lot of work, that the consequence your commanding officer claimed was a result of the set of premises he

gave is invalid. Next you must prove this fact at a court-martial. Yes, it could be very important. But the above method need not be as straightforward as the examples indicate.

**Special Method 2.9.2 (Difficulties with Method 2.9.1.)** (Case studies.) This special method, can brake down and become very complex in character for one basic reason. Either the selection of the (might be) consequence as an  $F$  or the selection of any of the premises as a  $T$  need not produce fixed values for the atoms. Now what do you do? For the case study difficulties, its easier to establish INVALID consequences.

(1) Suppose that your assumption that the (may be) consequence  $B$  has truth-value  $F$  does not yield unique atomic truth-values. Then you must brake up the problem into all the cases produced by all the different possible truth-values for the atoms in  $B$ .

**Example 2.9.2.1** Let  $B = P \leftrightarrow Q$ . Then for  $v(P \leftrightarrow Q) = F$  there are the following two cases. (a)  $v(P) = F, v(Q) = T$ . (b)  $v(P) = T, v(Q) = F$ .

(2) For premises that are not forced to have specific truth-values, then your selection of a truth-value for a (possible) premise  $A$  need not yield unique atomic truth-values. This will lead to more case studies. Indeed, possible case studies within case studies.

(3) During any of the specific case studies if the truth-values of all possible premises yields  $T$ , then you may stop for you have an invalid consequence.

(4) If during any case study you get one or more of the assume premises to be forced to be  $F$ , then this does NOT indicate that you have a valid consequence. You must get an  $F$  for some assumed premise for all possible case studies before you can state that it is a valid argument.

**Example 2.9.2.2** Suppose that you what to answer the question  $P \rightarrow R, Q \rightarrow S, (\neg R) \vee (\neg S) \stackrel{?}{=} P \wedge Q$ .

(i) Let  $v(P \wedge Q) = F$ . You have three cases. (a)  $v(P) = F, v(Q) = F$ . (b)  $v(P) = T, v(Q) = F$ . (c)  $v(P) = F, v(Q) = T$ .

Case (a). No assumed premise is forced to be anything. So, select  $v(Q \rightarrow S) = T$ . This yields two subcases. (a<sub>1</sub>)  $v(S) = F$ , (a<sub>2</sub>)  $v(S) = T$ .

Case (b). Again let  $v(Q \rightarrow S) = T$ . Again we have two subcases. (b<sub>1</sub>)  $v(S) = F$ , (b<sub>2</sub>)  $v(S) = T$ .

Case (c). Again let  $v(Q \rightarrow S) = T$ . Now this  $\Rightarrow v(S) = T$ .

(ii) Now we would go back and select another assumed premises such as  $P \rightarrow R$  and set its value to  $T$ . Then assuming cases (a), (a<sub>1</sub>) see what happens to the atoms in  $P \rightarrow R$ . This might produce more cases such as (a<sub>11</sub>) and an (a<sub>12</sub>). We would have a lot to check if we believed that  $B$  might be a valid consequence.

(iii) Notice that we have only one more assumed premises remaining  $(\neg R) \vee (\neg S)$ . We can assume that  $v(P \rightarrow R) = T$  and there are atomic values that will produce this truth-value. Now  $S$  does not appear in this formula hence under condition (b<sub>1</sub>)  $v(S) = F, v((\neg R) \vee (\neg S)) = T$ . Hence we have found a special assignment that shows that  $B$  is an invalid consequence.

(iv) Lets hope the method doesn't lead to many case studies since it might be better to use truth-tables.

NOTE ON FORMULA VARIABLES. You do not need to use the atomic form of a formula when a valid consequence is being determined. What you actually can do is to substitute for every specific atom in every place it appears a formula variable symbol, and distinct variables for distinct atoms. If for each variable formula symbol you substitute a fixed formula in atomic form, then in the valid consequence truth-table the various levels at which the premises are  $T$  is only dependent on the connectives that are in the original formula prior to substitution if the premise is not a single atom. If it is a single atom, then the atom as a premise still only depends upon it being give a  $T$  value. The same would be true for any formula substituted throughout the premises and assumed consequence for that atom. Thus, in exercise 1 below formula variable

symbols have been used. Simply consider them to behave like atoms. Each time you determine that the indicated formula is a valid consequence, then you have actually determined the case for infinitely many formula. But if it is an invalid consequence, then you cannot make such a variable substitution. Such an “invalid” result only holds for atoms.

---



---

### EXERCISE 2.9

1. Using the special method 2.9.1 or 2.9.2 (in the formula variable form) to determine whether or not

(a)  $(\neg A) \vee B, C \rightarrow (\neg B) \models A \rightarrow C.$

(b)  $A \rightarrow (B \rightarrow C), (C \wedge D) \rightarrow E, (\neg G) \rightarrow (D \wedge (\neg E)) \models A \rightarrow (B \rightarrow G).$

(c)  $(A \vee B) \rightarrow (C \wedge D), (D \vee E) \rightarrow G \models A \rightarrow G.$

(d)  $A \rightarrow (B \wedge C), (\neg B) \vee D, (E \rightarrow (\neg G)) \rightarrow (\neg D), B \rightarrow (A \vee (\neg E)) \models B \rightarrow E.$

2. Translate the following natural language arguments into propositional formula using the indicated propositional symbols and determine by method 2.9.1 or 2.9.2 whether or not the argument is valid or invalid. (Remember that you do NOT need to know what the terms in a phrase mean to check the validity of an argument.)

(a) Either I shall go home (H), or stay and study (S). I shall not go home. Therefore I shall stay and study.

(b) If the set of real numbers is infinite (I), then it has cardinality  $c$  (C). If the set of real numbers is not infinite, then it forms a finite set (D). Therefore, either the set of real numbers has cardinality  $c$  or it forms a finite set.

(c) A Midshipman’s wage may sometime increase (S) only if there is inflation (I). If there is inflation, then the cost of living will increase (C). Now and then a Midshipman’s wage has increased. Therefore, the cost of living has increased.

(d) If 2 is a prime number (P), then it is the least prime number (L). If 2 is the least prime number, then 1 is not a prime number (N). The number 1 is not a prime number. Therefore, 2 is a prime number.

(e) Either the set of real numbers is well-ordered (W) or it contains a well-ordered subset (C). If the set of real numbers is well-ordered, then every nonempty subset contains a first element (R). The natural numbers form a well-ordered subset of the real numbers (N). Therefore, the real numbers are well-ordered.

(f) If it is cold tomorrow (C), then I’ll wear my heavy coat (I) if the sleeve is mended (M). It will be cold tomorrow and the sleeve will not be mended. Therefore, I’ll not wear my heavy coat.

(g) If the lottery is fixed (L) or the Colts leave town again (C), then the tourist trade will decline (D) and the town will suffer (S). If the tourist trade decreases, then the police force will be more content (P). The police force is never content. Therefore, the lottery is fixed.

---



---

### 2.10 Satisfaction and Consistency.

As mentioned previously, the concept of when a set of formula is satisfied is of considerable importance. Suppose that we assume that a set of premises refer to “things” that occur in reality. As you’ll see, in order for a set of premises to differentiate between different occurrences it must be satisfiable. We recall the definition.

---

**Definition 2.10.1** (Satisfaction.) A nonempty (finite) set of premises  $A_1, \dots, A_n$  is *satisfiable* if there exists an assignment  $\underline{a}$  to all the atoms that appear in the premises such that  $v(A_i) = T$  for each  $i$  such that  $1 \leq i \leq n$ .

---

One way to attack the problem of satisfaction is to make a truth-table. If there is a row such that under every  $A_i$  there is a  $T$ , then the set of premises is satisfiable. As we did in the previous section, there is a short way to do this without such specific truth-tables. But, for the propositional calculus, why is satisfaction so important?

---

**Definition 2.10.2** A set of formula  $A_1, \dots, A_n$  is *consistent* if for each  $B \in L$ ,  $A_1, \dots, A_n \not\models B \wedge (\neg B)$ . A set of premises is *inconsistent* if there exist some  $B \in L$  such that  $A_1, \dots, A_n \models B \wedge (\neg B)$ .

---

Actually definition 2.10.2 is technical in character since if we only had this definition it might never (in time) be possible to know whether a set of premises is consistent. Also, as yet consistency may not seem as an important property. Notice that that formula  $B \wedge (\neg B)$  is a contradiction. Thus sometimes a set of premises that is *inconsistent* are also said to be *contradictory*. Notice that definition 2.10.2 includes the possible empty set of premises. This yields the pure validity concept. The next result shows that our pure validity concept is consistent.

**Theorem 2.10.1** If  $B \in L$ , then  $\not\models B \wedge (\neg B)$ .

Proof. Let (for an appropriate assignment  $\underline{a}$ )  $v(B) = T$ . Then  $v(B \wedge (\neg B)) = F$ . On the other hand, if  $v(B) = F$ , then  $v(B \wedge (\neg B)) = F$ . Since every assignment to  $B \wedge (\neg B)$  is an assignment to  $B$  and conversely, the result follows. ■

As mentioned above, it is assumed by many individuals, although it cannot be established, that human deduction corresponds to a humanly comprehensible “occurred in reality” concept. I won’t discuss the philosophical aspects of this somewhat dubious assumption, but even if it’s, at the least, partially true the concept of consistency is of paramount importance. Theorem 2.10.1 gives a slight indication of what is going on. Not every formula in our language is a valid formula. The concept of *simply consistent* is defined by the statement that a set of premises is simply consistent if not all formula are consequences of the premises. Obviously, by theorem 2.10.1, there is no difference between the two concepts for an empty set of premises.

The worst thing that can happen for any nonempty set of premises  $A_1, \dots, A_n$  in the scientific or technical areas is that  $A_1, \dots, A_n \models B$ , where  $B$  is ANY member of  $L$ . Why? This would mean that all formula including contradictions are valid consequences. Now if we associate with  $A_1, \dots, A_n \models B$ , the notion that if each  $A_i$  occurs in reality, then  $B$  will occur in reality, then this worst case scenario says “all things  $B$  will occur in reality.” Intuitively, this just doesn’t imply that any theory based upon this set of premises cannot differentiate between occurrences, but “true” could not be differentiated from “false.” But how can we know when a set of premises has this worst case scenario property?

**Theorem 2.10.2** A nonempty set of premises  $A_1, \dots, A_n$  is inconsistent if and only if  $A_1, \dots, A_n \models B$  for every  $B \in L$ .

Proof. Let  $A_1, \dots, A_n$  be inconsistent and any  $B \in L$ . Then there is some  $C \in L$  such that  $A_1, \dots, A_n \models C \wedge (\neg C)$ . Considering any assignment  $\underline{a}$  to the atoms in  $C$  and  $B$ , then  $v(C \wedge (\neg C)) = F$ . Hence,  $C \wedge (\neg C) \models B$ . Application of theorem 2.8.4 (ii) yields  $A_1, \dots, A_n \models B$ .

Conversely, simply let the formula in  $L$  be  $C \wedge (\neg C)$ . Then  $A_1, \dots, A_n \models C \wedge (\neg C)$  satisfies the definition. ■

**Corollary 2.10.2.1** A nonempty set of premises  $A_1, \dots, A_n$  is consistent if and only if there exists some  $B \in L$  such that  $A_1, \dots, A_n \not\models B$ .

Well, the above definitions and theorems, although they give us information about the concept of inconsistency, DO NOT GIVE any actual way to determine whether or not a set of premises is consistent. The theorems simply say that we need to check valid consequences for infinity many formula. Not an easy thing to do. For over 2,000 years, there was no way to determine whether or not a set of premises was consistent except to show that human propositional deduction leads to a specific contradiction.

**Theorem 2.10.3** A nonempty set of premises  $A_1, \dots, A_n$  is inconsistent if and only if it is not satisfiable.

Proof. Assume that  $A_1, \dots, A_n$  is inconsistent. Thus there is some  $B \in L$  such that  $A_1, \dots, A_n \models B \wedge (\neg B)$ . Hence,  $\models (A_1 \wedge \dots \wedge A_n) \rightarrow (B \wedge (\neg B))$  by the Deduction theorem. But for any assignment to atoms in  $A_i$  and  $B$ ,  $v(B \wedge (\neg B)) = F$ . Now let  $A_1, \dots, A_n$  be satisfiable. Hence, there is an assignment  $v$  such that  $v(A_i) = T$ ,  $i = 1, \dots, n$ . Extend this assignment to  $v'$  so that it is an assignment for any different atoms that might appear in  $B$ . Thus,  $v'(A_1 \wedge \dots \wedge A_n) \rightarrow (B \wedge (\neg B)) = F$ . This contradicts the stated Deduction theorem. Hence, inconsistency implies not satisfiable.

Conversely, suppose that  $A_1, \dots, A_n$  is not satisfiable. Then for any  $B \in L$ ,  $A_1, \dots, A_n \models B$  from the definition of satisfiable (theorem 2.8.1). By theorem 2.10.2,  $A_1, \dots, A_n$  is inconsistent.

**Corollary 2.10.3.1** A nonempty set finite of premises is consistent if and only if it is satisfiable.

Since the concept of satisfaction is dependent upon the concept of valid consequence, the same *variable substitution* process (page 59) can be used for the atoms that appear in each premise. Thus when you consider the formula variables as behaving like atoms, when inconsistency is determined, you have actually shown that infinitely many sets of premises are inconsistent. Consistency, however, only holds for atoms and not for the \* type of variable substitution. As an example, the set  $P \rightarrow Q$ ,  $Q$  is a consistent set, but  $P \rightarrow ((\neg R) \wedge R)$ ,  $(\neg R) \wedge R$  is an inconsistent set. Now, it is theorem 2.10.3 and its corollary that gives a specific and FINITE method to determine consistency. A (large sometimes) truth-table will do the job. But we can also use a method similar to the forcing method of the previous section.

---

**Special Method 2.10.1** The idea is to try and to pick out a specific assignment that will satisfy a set of premises, or to show that when you select a set of premises to be  $T$ , then this  $\Rightarrow$  a premise to be  $F$  and, hence, the set would be inconsistent.

(1) First, if the premises are written in formula variables then either substitute atoms for the variables or, at the least, consider them to be atoms.

(2) Now select a premise, say  $A_1$  and let  $v(A_1) = T$ . If possible select a premise that forces a large number of atoms to have fixed values. If this is impossible, then case studies may be necessary.

(3) Now select another premise that uses the maximum number of the forced atoms and either show that this premise has a value  $T$  or  $F$ . If it has a value  $F$  and there are no case studies then the set is inconsistent. If it is  $T$  or you can select it to be  $T$ , then the process continues.

(4) If the process continues, then start again with (3). Again if a premise is forced to be  $F$ , then the set is inconsistent. This comes from the fact that the other premises that have thus far been used are FORCED to be  $T$ .

(5) If the process continues until all premises are forced to be  $T$ , then what has occurred is that you have found an assignment that yields that the set is consistent.

(6) If there are case studies, the process is more difficult. A case study is produced when a  $T$  value for a premise has non-fixed truth-values for the atoms. You must get a forced  $F$  for each case study for the set to be inconsistent. If you get all premises to be  $T$  for any case study, then the set is consistent.

(7) Better still if you'll remember what you're trying to establish, then various short cuts can be used. For consistency, we are trying to give a metalogic argument that there is an assignment that gives a  $T$  for all premises. Or, for inconsistency, show that under the assumption that some premises are  $T$ , then this will force, in all cases, some other premise to be an  $F$ .

---

**Example 2.10.1** Determine whether or not the set of premises  $(A \vee B) \rightarrow (C \wedge D)$ ,  $(D \vee F) \rightarrow G$ ,  $A \vee (\neg G)$  (written in formula variable form) is consistent. First, re-express this set in terms of atoms.  $(P \vee Q) \rightarrow (R \wedge S)$ ,  $(S \vee S_1) \rightarrow S_2$ ,  $P \vee (\neg S_2)$ .



(a) Let  $v(P \vee (\neg S_2)) = T$ . Then there are three cases.

$$(a_1), v(P) = T, v(S_2) = F;$$

$$(a_2), v(P) = T, v(S_2) = T;$$

$$(a_3), v(P) = F, v(S_2) = F.$$

(b) But, consider the first premise. Then  $v((P \vee Q) \rightarrow (R \wedge S)) = T$ . Now consider case  $(a_1)$ . Then  $v(P \vee Q) = T \Rightarrow v(R \wedge S) = T \Rightarrow v(R) = v(S) = T$ . Still under case  $(a_1)$ ,  $\Rightarrow v((S \vee S_1) \rightarrow S_2) = F$ . But we must continue for the other cases for this (b) category. Now for  $(a_2)$ , we have that  $v((S \vee S_1) \rightarrow S_2) = T$ . Hence, we have found assignments that yield  $T$  for all premises and the set is consistent.

**Example 2.10.2** Determine whether or not the set of premises  $A \leftrightarrow B$ ,  $B \rightarrow C$ ,  $(\neg C) \vee D$ ,  $(\neg A) \rightarrow D$ ,  $\neg D$ . (written in formula variable form) is consistent. First, re-express this set in terms of atoms.  $P \leftrightarrow Q$ ,  $Q \rightarrow R$ ,  $(\neg R) \vee S$ ,  $(\neg P) \rightarrow S$ ,  $\neg S$ .

(a) Let  $v(\neg S) = T \Rightarrow S = F$ .

(b) Let  $v((\neg R) \vee S) = T \Rightarrow v(R) = F$ .

(c) Let  $v(Q \rightarrow R) = T \Rightarrow v(Q) = F$ .

(d) Let  $v(P \leftrightarrow Q) = T \Rightarrow v(P) = F \Rightarrow v((\neg P) \rightarrow S) = F$ . Thus the set is inconsistent and, hence, we can substitute the original formula variables back into the set of premises.

If  $\models$  is associated with ordinary propositional deduction, then it should also mirror the propositional metalogic we are using. One of the major metalogical methods we are using is called “proof by contradiction.” This means that you assume as an additional premise the negation of the conclusion. Then if you can establish a contradiction of anything, then the given hypotheses can be said to “logically” establish the conclusion. The next theorem about valid consequence mirrors this notion.

**Theorem 2.10.4** For any set of premises,  $A_1, \dots, A_n \models B$  if and only if  $A_1, \dots, A_n, \neg B \models C \wedge (\neg C)$  for some  $C \in L$ .

Proof. Let  $A_1, \dots, A_n \models B$ . If  $A_1, \dots, A_n$  is inconsistent, then  $A_1, \dots, A_n \models C \wedge (\neg C)$  for all  $C \in L$ . Adding any other premise such as  $\neg B$  does not alter this. So, assume that  $A_1, \dots, A_n$  is consistent. Hence, consider any assignment  $\underline{a}$  to all the atoms such that  $v(A_i) = T$ ,  $1 \leq i \leq n$  and  $v(B) = T$  and such an assignment exists. Thus for any such assignment  $v(\neg B) = F$ . Consequently, for any assignment  $\underline{b}$  either  $v(A_j) = F$  for some  $j$  such that  $1 \leq j \leq n$ , or all  $v(A_i) = T$  and  $v(\neg B) = F$ . Hence,  $A_1, \dots, A_n, \neg B$  is not satisfied. Hence, for some (indeed, any)  $C \in L$ ,  $A_1, \dots, A_n, \neg B \models C \wedge (\neg C)$ .

Conversely, let  $A_1, \dots, A_n, \neg B \models C \wedge (\neg C)$  for some  $C \in L$ . Then  $A_1, \dots, A_n, \neg B$  is inconsistent and thus given any assignment  $\underline{a}$  such that  $v(A_i) = T$  for each  $i$  such that  $1 \leq i \leq n$ , then  $v(\neg B) = F$ . Or, in this case,  $v(B) = T$ . Consequently,  $A_1, \dots, A_n \models B$ . ■

---



---

### EXERCISES 2.10

1. By the special method 2.10, determine if the indicated set of premises is consistent.

(a)  $A \rightarrow (\neg(B \wedge C))$ ,  $(D \vee E) \rightarrow G$ ,  $G \rightarrow (\neg(H \vee I))$ ,  $(\neg C) \wedge E \wedge H$ .

(b)  $(A \vee B) \rightarrow (C \wedge D)$ ,  $(D \vee E) \rightarrow G$ ,  $A \vee (\neg G)$ .

(c)  $(A \rightarrow B) \wedge (C \rightarrow D)$ ,  $(B \rightarrow D) \wedge ((\neg C) \rightarrow A)$ ,  $(E \rightarrow G) \wedge (G \rightarrow (\neg D))$ ,  $(\neg E) \rightarrow E$ .

(d)  $(A \rightarrow (B \wedge C)) \wedge (D \rightarrow (B \wedge E))$ ,  $((G \rightarrow (\neg A)) \wedge H) \rightarrow I$ ,  $(H \rightarrow I) \rightarrow (G \wedge D)$ ,  $\neg((\neg C) \rightarrow E)$ .

---



---

## 2.11 Proof Theory – General Concepts.

Actually, we are investigating the propositional logic in a historically reversed order. The concept of *proof theory* properly began with Frege’s *Begriffsschrift* which appeared in 1879 and was at its extreme with *Principia Mathematica* written by Whitehead and Russell from 1910–1913. Philosophically, proof “theory,” even though it can become very difficult, seems to the nonmathematician to be somewhat more “pure” in its foundations since it seems to rely upon a very weak mathematical foundation if, indeed, it does have such a foundation. However, to the mathematician this could indicate a kind of weakness in the basic tenants associated with the concept of the *formal proof*. Notwithstanding these philosophical differences, basic proof theory can be investigated without utilizing any strong mathematical procedures. Since we are studying mathematical logic, we will not restrict our attention to the procedures used by the formal logician but, rather, we are free to continue to employ our metamathematical concepts.

The concept of *formalizing* a logical argument goes back to Aristotle. But it again took over 2,000 years before we could model, in another formal way, the various Aristotle formal logical arguments. Proof theory first requires a natural language algorithm that gives simple rules for writing a formal proof. The rules that are used can be checked by anyone with enough training to apply the same rules. But, in my opinion, the most important part of proof theory is the fact that we view the process externally while the philosophical approach views the process internally. (We study the forest, many philosophers study the trees, so to speak.) For example, we know that every propositional formula can be replaced by an equivalent formula expressed only in the connectives  $\neg$  and  $\rightarrow$ . Thus we can simplify our language construction process considerably.

---

**Definition 2.11.1** (The Formal Language  $L'$ .)

- (1) You start at step (2) of definition 2.2.3.
- (2) Now you go to steps (3) — (6) of definition 2.2.3 but only use the  $\neg$  and  $\rightarrow$  connectives.

---

Notationally, the language levels constructed in definition 2.11.1 are denoted by  $L'_n$  and  $B \in L'$  if and only if there is some  $n \in \mathbb{N}$  such that  $B \in L'_n$ . Also don’t forget that level  $L'_n$  contains all of the previous levels. Clearly  $L'$  is a proper subset of  $L$ . Also, all the definitions of size, and methods to determine size, and simplification etc. hold for  $L'$ .

Now proof theory does not rely upon any of the concepts of truth—falsity, what will or will not occur in reality, and the like we modeled previously. All the philosophical problems associated with such concepts are removed. It is pure, so to speak. But as mention it relies upon a set of rules that tells us in a step-by-step manner, hopefully understood by all, exactly what formulas we are allowed to write down and exactly what manipulations we are allowed to perform with these formulas. It’s claimed by some that, at the least, it’s mirroring some of the procedures the human beings actually employ to obtained a logical conclusion from a set of premises. Proof theory is concerned with the notion of logical argument. It, of course, is also related to the metalogical methods the human being uses. We start with the rules for a *formula theorem* that is obtained from an empty set of premises. The word “theorem” as used here does not mean the metalanguage things called “Theorems” in the previous sections. It will mean a specially located formula. We can use formula variables and connectives to write formula schemata or schema. Each schemata would represent infinitely many specific selections from  $L'$ . We will simply call these *formulas* and use the proper letters to identify them as formula variables.

---

**Definition 2.11.2** (A formal proof of a theorem.)

- (1) A *formal proof* contains two FINITE COLUMNS, one of formulas  $B_i$ , the other column stating the reason  $R_i$  you placed the formula in that step.

$B_1$

$R_1$

$B_2$	$R_2$
...	...
...	...
...	...
...	...
$B_n$	$R_n$

The formula used represent any members of  $L'$  and each must be obtained in the following manner.

(2) A step  $i$  in the formal proof corresponds to a specific formula  $B_i$ . It can be a specific instance of one of the following axioms. For *any* formula  $A, B, C$  where as before  $A, B, C$  are formula variables (we note that because of the way we have of writing subformula, the  $A, B, C$  can also be considered as expressed in formula variables), write

- $P_1 : A \rightarrow (B \rightarrow A),$
- $P_2 : (A \rightarrow (B \rightarrow C)) \rightarrow ((A \rightarrow B) \rightarrow (A \rightarrow C)),$
- $P_3 : ((\neg A) \rightarrow (\neg B)) \rightarrow (B \rightarrow A).$

(3) Formula can only be obtained by one other procedure. It's called *modus ponens* and is abbreviated by the symbol MP. It's the only way that we can obtain a formula not of the type in (2) and is considered to be our one rule of logical inference.

Step  $B_j$  is obtained if there are two PREVIOUS steps  $B_i$  and  $B_k$  such that

- (i)  $B_i$  is of the form  $A,$
- (ii)  $B_k$  is of the form  $A \rightarrow B.$  Then
- (iii)  $B_j$  is of the form  $B$

Note that the order of the two needed previous steps  $B_i$  and  $B_k$  is not specified. All that's needed is that they come previous to  $B_j.$

(4) The *last step* in the finite column is called a (formal) *theorem* and the total column of formulas is called the (formal) *proof of theorem*.

(5) If a proof of a theorem  $E$  exists, then this is denote by  $\vdash E.$

Since we are using variables, any proof of a theorem is actually a proof for any formula you substitute for the respective variables (i.e. infinitely many proofs for specific formula.) In our examples, problems and the like, I won't repeat the statement "For any  $A \in L'.$ " The fact that I'm using variable symbols will indicate this.

**Example 2.11.1**

Show that  $\vdash A \rightarrow A.$

Proof.

- (1)  $(A \rightarrow ((A \rightarrow A) \rightarrow A)) \rightarrow ((A \rightarrow (A \rightarrow A)) \rightarrow (A \rightarrow A))$   $P_2$
- (2)  $A \rightarrow ((A \rightarrow A) \rightarrow A)$   $P_1$
- (3)  $(A \rightarrow (A \rightarrow A)) \rightarrow (A \rightarrow A)$   $MP(1,2)$
- (4)  $A \rightarrow (A \rightarrow A)$   $P_1$
- (5)  $A \rightarrow A$   $MP(3,4)$

The MP step must include the previous step numbers used for the MP step. Now any individual who can follow the rules can check that this last formula was obtained correctly. Also, there are many other

proofs that lead to the same result. The idea is the same as used to demonstrate a Euclidean geometry proof, but there is no geometric intuition available. Now at any point in some other proof if you should need the statement  $A \rightarrow A$  as one of your steps (of course, you can use another symbol for  $A$ ) then you could substitute the above finite proof just before the step is needed and re-number all steps. BUT, rather than do this all you need to do is to write the symbol  $\vdash A \rightarrow A$  since this indicates that a proof exists. By the way, there is stored at a university in Holland literally thousand upon thousands of formal proofs. However, in this course almost all of the formal proofs exhibited will be needed to establish our major results. These are to show that the formal proof of a formal theorem is equivalent to the modeling concept we call validity.

One of the major results observed by Aristotle was the logical argument he called *hypothetical syllogism* or HS. We next use the above procedure to establish this. But it's a method of introducing a formal proof and our result is a metatheorem proof.

**Theorem 2.11.1** Assume that you have two steps in a possible proof of the form (i)  $A \rightarrow B$  and (j)  $B \rightarrow C$ . Then you can write down at a larger step number (iii)  $A \rightarrow C$ .

Proof.

- |         |   |                    |
|---------|---|--------------------|
| (1)     | . . . . .   |                    |
|         | ...   |                    |
|         | ...   |                    |
| (i)     | $A \rightarrow B$   | $R_i$              |
|         | ...   |                    |
|         | ...   |                    |
| (j)     | $B \rightarrow C$   | $R_j$              |
| (j + 1) | $(B \rightarrow C) \rightarrow (A \rightarrow (B \rightarrow C))$                                 | $P_1$              |
| (j + 2) | $(A \rightarrow (B \rightarrow C))$   | $MP(j, j + 1)$     |
| (j + 3) | $(A \rightarrow (B \rightarrow C)) \rightarrow ((A \rightarrow B) \rightarrow (A \rightarrow C))$ | $P_2$              |
| (j + 4) | $(A \rightarrow B) \rightarrow (A \rightarrow C)$   | $MP(j + 2, j + 3)$ |
| (j + 5) | $A \rightarrow C$   | $MP(i, j + 4)$     |

Whenever we use HS, the reason is indicated by the symbol  $HS(i, j)$  in the same manner as is done for MP. IMPORTANT FACT. In the above metatheorem that yields HS, please note that the step (j) can come before step (i).

**Example 2.11.2**

$\vdash (\neg(\neg A)) \rightarrow A$

- |      |   |            |
|------|---|------------|
| (1)  | $(\neg(\neg A)) \rightarrow ((\neg(\neg(\neg(\neg A)))) \rightarrow (\neg(\neg A)))$  | $P_1$      |
| (2)  | $((\neg(\neg(\neg(\neg A)))) \rightarrow (\neg(\neg A))) \rightarrow ((\neg A) \rightarrow (\neg(\neg(\neg A))))$   | ....       |
| (3)  | $(\neg(\neg A)) \rightarrow ((\neg A) \rightarrow (\neg(\neg(\neg A))))$  | $HS(1, 2)$ |
| (4)  | $((\neg A) \rightarrow (\neg(\neg(\neg A)))) \rightarrow ((\neg(\neg A)) \rightarrow A)$  | ....       |
| (5)  | $(\neg(\neg A)) \rightarrow ((\neg(\neg A)) \rightarrow A)$   | $HS( , )$  |
| (6)  | $((\neg(\neg A)) \rightarrow ((\neg(\neg A)) \rightarrow A)) \rightarrow$<br>$(((\neg(\neg A)) \rightarrow (\neg(\neg A))) \rightarrow ((\neg(\neg A)) \rightarrow A))$   | $P_2$      |
| (7)  | $((\neg(\neg A)) \rightarrow (\neg(\neg A))) \rightarrow ((\neg(\neg A)) \rightarrow A)$  | $MP( , )$  |
| (8)  | $((\neg(\neg A)) \rightarrow (((\neg(\neg A)) \rightarrow (\neg(\neg A))) \rightarrow (\neg(\neg A)))) \rightarrow (((\neg(\neg A)) \rightarrow$<br>$((\neg(\neg A)) \rightarrow (\neg(\neg A)))) \rightarrow ((\neg(\neg A)) \rightarrow (\neg(\neg A))))$ | $P_2$      |
| (9)  | $(\neg(\neg A)) \rightarrow (((\neg(\neg A)) \rightarrow (\neg(\neg A))) \rightarrow (\neg(\neg A)))$   | ....       |
| (10) | $((\neg(\neg A)) \rightarrow ((\neg(\neg A)) \rightarrow (\neg(\neg A)))) \rightarrow$<br>$((\neg(\neg A)) \rightarrow (\neg(\neg A)))$   | $MP( , )$  |

- (11)  $(\neg(\neg A)) \rightarrow ((\neg(\neg A)) \rightarrow (\neg(\neg A)))$  ...  
 (12)  $(\neg(\neg A)) \rightarrow (\neg(\neg A))$  ...  
 (13)  $(\neg(\neg A)) \rightarrow A$   $MP( , )$

### EXERCISES 2.11

- (1) Rewrite the proof of  $\vdash (\neg(\neg A)) \rightarrow A$  as it appears in example 2.11.2 filling in the missing reasons. Some may be examples.
- (2) Give formal proofs of the next two theorems. You may use any previously established  $\vdash$ , or method. You must state all your reasons.
- (a)  $\vdash A \rightarrow (\neg(\neg A))$ .
- (b)  $\vdash (\neg B) \rightarrow (B \rightarrow A)$ .

### 2.12 Demonstrations, Deductions From Premises.

Given a nonempty set premises  $\Gamma$  (not necessarily finite), then what is the classical procedure employed to deduce a formula  $A$  from  $\Gamma$ ? Actually, we are only allowed to do a little bit more than we are allowed to do in order to give a proof of a formal theorem. The next definition gives the one additional rule that is assumed to be adjoined to definition 2.11.2 (formal proof of a theorem) in order to demonstrate that a formula is deducible from a given set of premises.

**Definition 2.12.1** (Deduction from premises.) A formula  $B \in L'$  is said to be *deduced from a set of  $\Gamma$*  or a *consequence of  $\Gamma$* , where  $\Gamma$  is a not necessary finite (but possibly empty) set of premises, if  $B$  is the last step in a FINITE column of steps and reasons as described in definition 2.11.2 where you are allowed one additional rule.

- (1) You may write down as any step a single instance of a formula as it appears in  $\Gamma$ , where the premises are written in formula variable form. The reason given is *premise*.
- (2) The finite column with reasons is called a *demonstration*.

Observe that whenever we have written a demonstration, because of the use of variables, we have actually written infinitely many demonstrations. Deduction from a set of premises is what one usually considers when one uses the terminology “a logical argument.” Now a proof of a theorem is a demonstration from an empty set of premises. When  $B$  is deduced from the set  $\Gamma$ , then this is symbolized by writing  $\Gamma \vdash B$ . The very straightforward definition 2.12.1 yields the following simple results.

**Theorem 2.12.1** *Assume that  $\Gamma$  is any set of formula.*

- (a) *If  $A \in \Gamma$ , or  $A$  is an instance of an axiom, then  $\Gamma \vdash A$ .*
- (b) *If  $\Gamma \vdash A$  and  $\Gamma \vdash A \rightarrow B$ , then  $\Gamma \vdash B$ .*
- (c) *If  $\vdash A$ , then  $\Gamma \vdash A$ .*
- (d) *If  $\Gamma$  is empty and  $\Gamma \vdash A$ , then  $\vdash A$ .*
- (e) *If  $\Gamma \vdash A$  and  $D$  is any set of formula, then  $\Gamma \cup D \vdash A$ .*
- (f) *If  $\Gamma \vdash A$ , then there exists some finite subset  $D$  of  $\Gamma$  such that  $D \vdash A$ .*

Proof. (A) Let  $A \in \Gamma$ . Then one step consisting of the line “(1)  $A$ . . . . . Premises” is a demonstration for  $A$ . If  $A$  is an axiom, then one step from definition 2.11.2 yields a demonstration.

(b) Let  $B_1, \dots, B_m$  be the steps in a demonstration that  $A$  is deducible from  $\Gamma$ . Then  $B_m = A$ . Let  $C_1, \dots, C_k$  be a demonstration that  $A \rightarrow B$  is deducible from  $\Gamma$ . Now after writing the steps  $B_{m+i} = C_1, i = 1, 2, \dots, k$  add the step  $C_{k+1} : B. \dots \dots MP(m, m + k)$ . Then this yields a demonstration that  $B$  is deducible from  $\Gamma$ .

(c) Obvious.

(d) Since  $\Gamma$  is empty, rule (1) of definition 2.11.2 has no application. Hence, only the rules for a proof of a formal theorem have been used and this result follows.

(e) We have, possibly, used formulas from  $\Gamma$  to deduce  $A$ . We have, possibly, used formulas from  $\Gamma \cup D$  to deduce  $A$ .

(f) Assume that  $\Gamma \vdash A$ . Now let  $D$  be the set of all premises that have been utilized as a specific step marked “premise” that appears in the demonstration  $\Gamma \vdash A$ . Obviously, we may replace  $\Gamma$  with  $D$  and have not altered the demonstration. ■

**Example 2.12.1** To show that  $(\neg(\neg A)) \vdash A$ .

(1) $(\neg(\neg A))$	Premise
(2) $(\neg(\neg A)) \rightarrow ((\neg(\neg(\neg(\neg A)))) \rightarrow (\neg(\neg A)))$	.....
(3) $(\neg(\neg(\neg(\neg A)))) \rightarrow (\neg(\neg A))$	$MP(, )$
(4) $((\neg(\neg(\neg(\neg A)))) \rightarrow (\neg(\neg A))) \rightarrow ((\neg A) \rightarrow (\neg(\neg(\neg A))))$	.....
(5) $(\neg A) \rightarrow (\neg(\neg(\neg A)))$	$MP(, )$
(6) $((\neg A) \rightarrow (\neg(\neg(\neg A)))) \rightarrow ((\neg(\neg A)) \rightarrow A)$	.....
(7) $(\neg(\neg A)) \rightarrow A$	$MP(, )$
(8) $A$	$MP(, )$

Notice that example 2.12.1 and example 2.11.3 show that  $\vdash (\neg(\neg A)) \rightarrow A$  involve similar formulas. Moreover, we have not used HS in example 2.12.1. Indeed, if we had actually made the HS substitution into steps of example 2.11.3, then we would have at the least 21 steps in example 2.11.3. Even though we have not considered as yet any possibilities that the semantical methods which have previously been employed might be equivalent in some sense to the pure proof methods of this and section 2.11, it would certainly be of considerable significance if there was some kind of deduction theorem for our proof theory. We can wonder if it might be possible to substitute for  $\models$  in the metatheorem  $\models (\neg(\neg A)) \rightarrow A$  if and only if  $(\neg(\neg A)) \models A$  the symbol  $\vdash$ ? Further, it's possible to stop at this point and, after a lot of formal work, introduce you to the actual type of deduction process used to create a universe. But to avoid the formal proofs of the needed special formal theorems, I'm delaying this introduction until we develop the complete equivalence of valid formulas and formal theorems. I'll answer the previous question by establishing one of the most powerful procedures used to show this equivalence.

## EXERCISES 2.12

(1) Rewrite example 2.12.1 filling in the missing reasons.

(2) Complete the following deductions from the indicated set of premises. Write down the missing steps and/or reasons.

Show that  $A \rightarrow B, B \rightarrow C \vdash A \rightarrow C$ .

(1) $(B \rightarrow C) \rightarrow (A \rightarrow (B \rightarrow C))$	$P_1$
(2) $B \rightarrow C$	.....
(3)	$MP(1, 2)$
(4) $(A \rightarrow (B \rightarrow C)) \rightarrow ((A \rightarrow B) \rightarrow (A \rightarrow C))$	.....
(5) $(A \rightarrow B) \rightarrow (A \rightarrow C)$	.....

(6)		Premises
(7) $A \rightarrow C$		.....
(b) Use 2(b) of exercise 2.11, to show in THREE steps that $(\neg A) \vdash A \rightarrow B$ .		
(c) Use the fact that $\vdash (B \rightarrow A) \rightarrow ((\neg A) \rightarrow (\neg B))$ and any previous results to show that $\neg(A \rightarrow B) \vdash B \rightarrow A$ .		
(1) $\neg(A \rightarrow B)$		Premise
(2) $\vdash (B \rightarrow (A \rightarrow B)) \rightarrow ((\neg(A \rightarrow B)) \rightarrow (\neg B))$		Given
(3)		$P_1$
(4)		.....
(5) $(\neg B)$		.....
(6) $(\neg B) \rightarrow (B \rightarrow A)$		.....
(7) $B \rightarrow A$		.....

### 2.13 The Deduction Theorem.

The Deduction Theorem is so vital to logic that some mathematicians, such as Tarski, use it as a basic axiom for different logical systems. The following metaproof was first presented in 1930 and it has been simplified by your present author. This simplification allows it to be extended easily to cover other types of logical systems. What this theorem does is to give you a step by step process to change a formal proof into another formal proof.

**Theorem 2.13.1** (The Deduction Theorem) *Let  $\Gamma$  a collection of formula from  $L'$  written in formula variable form. Assume that formula variables  $A, B$  represent arbitrary members of  $L'$ . Let  $\Gamma \cup \{A\}$  be the set of premises the contains and only contains the members of  $\Gamma$  and  $A$ . Then  $\Gamma \cup \{A\} \vdash B$  if and only if  $\Gamma \vdash A \rightarrow B$ .*

Proof. For the necessity, assume that  $\Gamma \cup \{A\} \vdash B$ . Then there exists a finite  $A_1, \dots, A_n \in \Gamma$  such that  $A_1, \dots, A_n, A \vdash B$ . (Of course no actual member of  $A_1, \dots, A_n$  need to be used.) Assume that every step has been written with the reasons as either a premise, or an axiom, or MP.

(a) Renumber, say in red, all of the steps that have reasons stated as premises or axioms. Assume that there are  $k$  such steps. Note that there must be at least three steps for MP to be a reason, and then it could only occur in step 3. We now construct a new demonstration.

Case ( $m = 1$ ). There is only one case. Let the formula be  $B_1$ . Hence,  $B_1 = B$ .

Subcase (1). Let  $B_1$  be a premise  $A_j$ . Assume that  $A_j \neq A$ . Now keep  $B_1 = A_j$  in the new demonstration and insert the two indicated steps (2) (3).

(1) $B_1 = A_j$	premise
(2) $A_j \rightarrow (A \rightarrow A_j)$	$P_1$
(3) $A \rightarrow A_j = A \rightarrow B$	$MP$

Now notice that the  $A$ , in these three steps does not appear as a single formula in a step.

Subcase (2). Assume that  $B_1 = A$ . Then insert the five steps that yields  $\vdash A \rightarrow A$  (Example 2.11.1.) into the new demonstration. Now do not place the step  $B_1 = A$  in the new demonstration. Again we have as the last step  $A \rightarrow A$  and  $A$  does not appear as any step for in this new demonstration.

Subcase (3). Let  $B_1 = C$  be any axiom. Simply repeat subcases (1) (2) and we have as a last step  $A \rightarrow C$  and  $A$  does not appear in any step.

Now we do the remaining by induction. Suppose that you have used  $m$  of the original renumbered steps to thus far construct the new demonstration. Now consider step number  $B_{m+1}$ . Well, just apply the same subcase procedures that are used under case  $m = 1$ . The actual induction hypothesis is vacuously employed (i.e. not employed). Thus by induction, for any  $k$  steps we have found a way to use all non-MP steps of the original demonstration to construct a new demonstration in such a manner that no step in the new demonstration has, thus far, only  $A$  as its formula. Further, all original non-MP steps  $B_i$  are replaced in the new demonstration by  $A \rightarrow B_i$ . Thus if the last formula  $B_n$  in the original demonstration is a non-MP step, then  $B_n = B$ , and the last step in the new demonstration is  $A \rightarrow B$ . We must now use the original MP steps to continue the new demonstration construction since  $A$  might be in the original demonstration an MP step or the last step of the original demonstration might be an MP step.

After using all of the original non-MP steps, we now renumber, for reference, all the original MP steps. We now define by induction on the number  $m$  of MP steps a procedure which will complete our proof.

Case ( $m = 1$ ) We have that there is only one application of MP. Let  $B_j$  be this original MP step. Then two of the original previous steps in the original demonstration, say  $B_g$  and  $B_h$ , were employed and  $B_h = B_g \rightarrow B_j$ . We have, however, in the new demonstration used these to construct the formula and we have not used the original  $B_j$  step. Now use the two new steps (i)  $A \rightarrow B_g$ , and (ii)  $A \rightarrow (B_g \rightarrow B_j)$  and insert immediately after new step (ii) the following:

$$\begin{array}{ll} \text{(iii)} & (A \rightarrow (B_g \rightarrow B_j)) \rightarrow ((A \rightarrow B_g) \rightarrow (A \rightarrow B_j)) & P_2 \\ \text{(iv)} & (A \rightarrow B_g) \rightarrow (A \rightarrow B_j) & MP(ii, iii) \\ \text{(v)} & A \rightarrow B_j & MP(i, iv) \end{array}$$

Now do not include the original  $B_j$  in the new demonstration just as in case where  $B_j = A$ .

Assume the induction hypothesis that we have  $m$  of the original MP steps used in the original demonstration now altered so that they appear as  $A \rightarrow \dots$

Case ( $m + 1$ ). Consider MP original step  $B_{m+1}$ . Hence, prior steps in the old demonstration, say  $B_g$ ,  $B_h = B_g \rightarrow B_{m+1}$  are utilized to obtain the  $B_{m+1}$  formula. However, all the original steps up to but not including the  $B_{m+1}$  have been replaced by a new step in our new demonstration in such a manner they now look like (vi)  $A \rightarrow B_g$  and (viii)  $A \rightarrow (B_g \rightarrow B_{m+1})$  no matter how these steps were originally obtained. (The induction hypothesis is necessary at this point.) Now follow the exact same insertion process as in the case  $m = 1$ . This yields a new step  $A \rightarrow B_{m+1}$  constructed from the original  $B_{m+1}$ . Consequently, by induction, we have defined a procedure by which all the original steps  $B_k$  have been used to construct a new demonstration and if  $B_n$  was one of the original formula, then it now appears in the new demonstration as  $A \rightarrow B_n$ . Further, no step in the new demonstration is the single formula  $A$ . This yields a newly constructed demonstration that  $A_1, \dots, A_n \vdash A \rightarrow B$ .

For the sufficiency, assume that  $\Gamma \vdash A \rightarrow B$ . The final step is  $B_k = A \rightarrow B$ . Now add the following two steps.  $B_{k+1} = A$  (premises), and  $B_{k+1} = B$ ,  $MP(k, k + 1)$ . This yields  $\Gamma \cup \{A\} \vdash B$ . ■

**Corollary 2.13.1.1**  $A_1, \dots, A_n \vdash B$  if and only if  $\vdash (A_1 \rightarrow (A_2 \rightarrow \dots (A_n \rightarrow B) \dots))$ .

Now in the example on the next page, I follow the rules laid out within the proof of the Deduction Theorem. The formula from the original demonstration used as a step in the new construction are represented in roman type. Formula from the original demonstration used to obtain the new steps BUT not included in the new demonstration are in Roman Type, BUT are placed between square brackets [ ]. In the case  $\vdash A \rightarrow A$ , I will not include all the steps.

**Example 2.13.1**

$$(I) A \rightarrow B, B \rightarrow C, A \vdash C.$$



(1) $A \rightarrow B$	Premise
(2) $B \rightarrow C$	Premise
(3) $A$	Premise
(4) $B$	$MP(1,3)$
(5) $C$	$MP(2,4)$

We now construct from (I) a new demonstration that

$$(II) A \rightarrow B, B \rightarrow C, \vdash A \rightarrow C.$$

(1) $A \rightarrow B$	Premise
(2) $(A \rightarrow B) \rightarrow (A \rightarrow (A \rightarrow B))$	$P_1$
(3) $A \rightarrow (A \rightarrow B)$	$MP(1,2)$
(4) $B \rightarrow C$	Premise
(5) $(B \rightarrow C) \rightarrow (A \rightarrow (B \rightarrow C))$	$P_1$
(6) $A \rightarrow (B \rightarrow C)$	$MP(4,5)$
(7) $\vdash A \rightarrow A$	Example 2.11.1
$[B_g = A, B_j = B]$	
(8) $(A \rightarrow (A \rightarrow B)) \rightarrow ((A \rightarrow A) \rightarrow (A \rightarrow B))$	$P_2$
(9) $(A \rightarrow A) \rightarrow (A \rightarrow B)$	$MP(3,8)$
(10) $A \rightarrow B$	$MP(7,9)$
$[B_g = B, B_j = C]$	
(11) $(A \rightarrow (B \rightarrow C)) \rightarrow ((A \rightarrow B) \rightarrow (A \rightarrow C))$	$P_2$
(12) $(A \rightarrow B) \rightarrow (A \rightarrow C)$	$MP(6,11)$
(13) $A \rightarrow C$	$MP(10,12)$

I hope this example is sufficient. But note that although this gives a demonstration, it need not give the most efficient demonstration.

### EXERCISES 2.13

1. Give a reason why we should NOT use the Deduction theorem as a reason that from  $A \vdash A$ , we have  $\vdash A \rightarrow A$ .
2. Complete the following formal proofs of the indicated theorems by application of the Deduction Theorem in order to insert premises. You will also need to insert, in the usual manner, possible  $\vdash$  statements obtained previously. Please give reasons.

(A) Show that  $\vdash (B \rightarrow A) \rightarrow ((\neg A) \rightarrow (\neg B))$

(1) $B \rightarrow A$	Premise and D. Thm.
(2) $\vdash (\dots) \rightarrow B$	Ex. 2.12.1 and D. Thm.
(3) $(\neg(\neg B)) \rightarrow A$	$HS(, )$
(4)	
(5) $(\neg(\neg B)) \rightarrow (\neg(\neg A))$	.....
(6) $((\neg(\neg B)) \rightarrow (\dots)) \rightarrow ((\neg A) \rightarrow (\neg B))$	.....
(7) .....	.....
(8) .....	D. Thm.

(B) Show that  $\vdash ((A \rightarrow B) \rightarrow A) \rightarrow A$

(1) $(A \rightarrow B) \rightarrow A$	.....
---------------------------------------	-------

(2) .....	D.Thm. and Ex 2.12.2b
(3) $(\neg A) \rightarrow A$	.....
(4) $(\neg A) \rightarrow (\neg(\neg((\neg A) \rightarrow A)) \rightarrow (\neg A))$	....
(5) $(\neg(\neg((\neg A) \rightarrow A)) \rightarrow (\neg A)) \rightarrow \dots$	$P_3$
(6) $(\neg A) \rightarrow (A \rightarrow \dots((\neg A) \rightarrow \dots))$	.....
(7) $((\neg A) \rightarrow (A \rightarrow (\neg((\neg A) \rightarrow A)))) \rightarrow (((\neg A) \rightarrow A) \rightarrow ((\neg A) \rightarrow (\neg((\neg A) \rightarrow A))))$	.....
(8) .....	$MP(, )$
(9) .....	$MP(3, 8)$
(10) $((\neg A) \rightarrow (\neg(\dots))) \rightarrow (((\neg A) \rightarrow \dots) \rightarrow \dots)$	$P_3$
(11) .....	$MP(, )$
(12) $A$	.....
(13) $\vdash \dots$	D. Thm.

[3] Use the following demonstration that  $A \rightarrow B$ ,  $A \vdash B$  and construct, as in example 2.13.1, by use of the procedures within the metaproof of the Deduction Theorem a formal demonstration that  $A \rightarrow B \vdash A \rightarrow B$ . [It's obvious that this will not give the most efficient demonstration.]

---

$A \rightarrow B, A \vdash B$	
(1) $A$	Premise
(2) $A \rightarrow B$	Premise
(3) $B$	$MP(1, 2)$

---

### 2.14 Deducibility Relations or $\models$ implies $\vdash$ almost.

The Deduction Theorem for formal demonstrations seems to imply that the semantical concept of  $\models$  and the proof-theoretic concept of  $\vdash$  are closely related for they share many of the same propositional facts. In this section, we begin the study which will establish exactly how these two seeming distinct concepts are related. Keep in mind, however, that  $\models$  depends upon the mirroring of the classical truth-falsity, will occur-won't occur notion while  $\vdash$  is dependent entirely upon the strict formalistic manipulation of formulas. We are in need of two more formal proofs.

**Example 2.14.1**  $\vdash A \rightarrow ((A \rightarrow B) \rightarrow B)$ .

(1) $A$	Premise
(2) $A \rightarrow B$	Premise
(3) $B$	$MP(1, 2)$
(4) $\vdash A \rightarrow ((A \rightarrow B) \rightarrow B)$	D. Thm.

**Example 2.14.2**  $\vdash A \rightarrow ((\neg B) \rightarrow (\neg(A \rightarrow B)))$ .

(1) $\vdash A \rightarrow ((A \rightarrow B) \rightarrow B)$	Ex. 2.14.1
(2) $((A \rightarrow B) \rightarrow B) \rightarrow ((\neg B) \rightarrow (\neg(A \rightarrow B)))$	Exer. 2.13 (A)
(3) $A \rightarrow ((\neg B) \rightarrow (\neg(A \rightarrow B)))$	$HS(1, 2)$

The theorem we will need is that of Example 2.14.2. As done previously, the formal proofs or demonstrations are done in formula variables. They hold for any formula consistently substituted for the variables. In the semantics sections, most but not all deduction-type concepts such as validity and valid consequences

also hold for formula variables. Non-validity was a notion that did not hold in formula variable form. In what follows, we again assume that we are working in formula variables. Of course, they also hold for atoms substituted for these variables. We use the notation for formula variables. Let  $A$  be a formula written in the following manner. The formula variables  $A_1, \dots, A_n$  and only these formula variables are used to construct  $A$  with the  $L'$  propositional connectives  $\neg, \rightarrow$ . Thus  $A$  is written in formula variables. Since  $L' \subset L$ , the truth-table concept can be applied to  $L'$ . Now let  $\underline{a}$  be an assignment to the atoms that would appear in each  $A_i$ ,  $i = 1, \dots, n$  when specific formula are substituted for the formula variables.

---

**Definition 2.14.1** For each  $i$ , we define a formula  $A'_i$  as follows:

- (i) if  $v(A_i) = T$ , then  $A'_i = A_i$ .
  - (ii) If  $v(A_i) = F$ , then  $A'_i = (\neg A_i)$ .
  - (iii) If  $v(A) = T$ , then  $A' = A$ .
  - (iv) If  $v(A) = F$ , then  $A' = (\neg A)$ .
- 

In the truth-table for  $A$ , reading from left to right, you have all the atoms then the formula  $A_i$  and finally the formula  $A$ . Then we calculate the  $A$  truth-value from the  $A_i$ , with possibly additional columns if needed.

---

**Definition 2.14.2** (Deducibility relations.) For each row  $j$  of the truth-table, there are truth-values for each of the  $A_i$  and  $A$ . These generate the formula  $A'_i$  and  $A'$ , where the  $A_i$  are the formula that comprise  $A$ .

- (i) The  $j$ th *Deducibility relation* is  $A'_1, \dots, A'_i \vdash A'$ .
- 

**Theorem 2.14.1.** *Given  $A_1, \dots, A_n$  and  $A$  as defined above. Then for any row of the corresponding truth-table for  $A$  generated by the truth-values for  $A_1, \dots, A_n$ , we have that  $A'_1, \dots, A'_n \vdash A'$ .*

Proof. First, assume that each  $A_i$  is an atom and  $A$  is expressed in atomic form. This allows for induction and for all the possible truth-values for non-atomic  $A_i$ . We now do an induction proof on the size of  $A$ .

Let  $\text{size}(A) = 0$ . The  $A = A_i$  for some  $i$  (possible more than one). As we know  $A_1, \dots, A_n \vdash A_i$  for any  $i$ ,  $i = 1, \dots, n$ . Thus the result follows by leaving the original  $A_i$  or replacing it with  $\neg A_i$  as the case may be.

Assume the induction hypotheses (in strong form) that the result holds for any formula  $A$  of size  $\leq m$  where  $m > 0$ . Let  $\text{size}(A) = m + 1$ .

There are two cases. (i) The formula  $A = \neg B$ , or case (ii)  $A = B \rightarrow C$ , where  $\text{size}(B), \text{size}(C) \leq m$ . Note that by the induction hypothesis if  $q_1, \dots, q_k$  are the atoms in  $B$ , then  $q'_1, \dots, q'_k \vdash B'$ . But adding any other finite set of atoms does not change this statement. Hence,  $A'_1, \dots, A'_n \vdash B'$ . In like manner,  $A'_1, \dots, A'_n \vdash C'$ .

Case (i). Let  $A = (\neg B)$  Then (a), suppose that  $v(B) = T$ . Then  $B' = B$  and  $v(A) = F$ . Hence,  $A' = (\neg A) = (\neg(\neg B))$ . To the demonstration that  $A'_1, \dots, A'_n \vdash B' = B$  adjoin the proof that  $\vdash B \rightarrow (\neg(\neg B))$ . Then consider one MP step. This yields the formula  $(\neg(\neg B)) = A'$ . Consequently,  $A'_1, \dots, A'_n \vdash A'$ .

Subcase (b). Let  $v(B) = F$ . Then  $v(A) = T$  yields that  $A = A'$ . Hence,  $A'_1, \dots, A'_n \vdash B' = (\neg B) = A = A'$ .

For case (ii), let (a),  $v(C) = T$ . Thus  $v(A) = T$  and  $C' = C$ ,  $A' = B \rightarrow C$ . Hence,  $A'_1, \dots, A'_n \vdash C$ . Now add the steps  $\vdash C \rightarrow (B \rightarrow C)$  and MP yields  $B \rightarrow C$ . Consequently,  $A'_1, \dots, A'_n \vdash B \rightarrow C = A'$ .

Now, let (b)  $v(B) = F$ . Then  $v(A) = T$ ,  $B' = (\neg B)$ ,  $A' = A = B \rightarrow C$ . Then consider  $A'_1, \dots, A'_n \vdash B' = (\neg B)$  and adjoin to this proof the proof of  $\vdash (\neg B) \rightarrow (B \rightarrow C)$ . (Exercise 2.12.2b) Then MP yields  $A'_1, \dots, A'_n \vdash B \rightarrow C = A'$ .

Next part (c) requires  $v(B) = T$ ,  $v(C) = F$ . Then  $v(A) = F$ ,  $B' = B$ ,  $C' = (\neg C)$ ,  $A' = (\neg A) = (\neg(B \rightarrow C))$ . Using both demonstrations for  $A'_1, \dots, A'_n \vdash B'$  and for  $A'_1, \dots, A'_n \vdash C'$  and the result of Example 2.14.2 that  $\vdash B \rightarrow ((\neg C) \rightarrow (\neg(B \rightarrow C)))$ , two applications of MP yields  $A'_1, \dots, A'_n \vdash (\neg(B \rightarrow C)) = A'$ . By induction, the proof is complete for atomic  $A_i$ . Note that the \* substitution process holds if done throughout each step of the formal proof. Applying this process, the result holds in general. ■

**Examples 2.14.3** Let  $A = B \rightarrow (\neg C)$ . Then

$B$	$C$	$A$
$T$	$T$	$F$
$T$	$F$	$T$
$F$	$T$	$T$
$F$	$F$	$T$

Deducibility relations

- (a)  $B, C \vdash (\neg(B \rightarrow (\neg C)))$ ,      (b)  $B, (\neg C) \vdash B \rightarrow (\neg C)$ ,  
(c)  $(\neg B), C \vdash B \rightarrow (\neg C)$ ,      (d)  $(\neg B), (\neg C) \vdash B \rightarrow (\neg C)$ .

### EXERCISES 2.14

1. For the following formula, write as in my example all of the possible deducibility relations.

- (a)  $A = (\neg B) \rightarrow (\neg C)$ . (b)  $A = B \rightarrow C$ . (c)  $A = B \rightarrow (C \rightarrow B)$ . (d)  $A = B \rightarrow (\neg(C \rightarrow D))$ .

### 2.15 The Completeness Theorem.

One of our major goals is now at hand. We wish to show that  $\models$  and that  $\vdash$  mean the same thing. As I mentioned, I'm presenting only the necessary formal theorems that will establish this fact. We need just one more. This will be example 2.15.4. We'll do this in a few small steps.

**Example 2.15.1**

$$(\neg A) \rightarrow A, (\neg A) \vdash B \text{ or } \vdash ((\neg A) \rightarrow A) \rightarrow ((\neg A) \rightarrow B).$$

- (1)  $(\neg A) \rightarrow A$  Premise  
(2)  $(\neg A)$  Premise  
(3)  $A$  MP(1, 2)  
(4)  $\vdash (\neg A) \rightarrow (A \rightarrow B)$  Exer. 2.11 (2b)  
(5)  $A \rightarrow B$  MP(2, 4)  
(6)  $B$  MP(3, 6)

**Example 2.15.2**

$$B \rightarrow C \vdash (\neg(\neg B)) \rightarrow C \text{ or } \vdash (B \rightarrow C) \rightarrow ((\neg(\neg B)) \rightarrow C)$$

- (1)  $B \rightarrow C$  Premise  
(2)  $(\neg(\neg B)) \rightarrow B$  Exam. 2.11.3

(3)  $(\neg(\neg B)) \rightarrow C$  HS(1, 2)

**Example 2.15.3**

$(\neg A) \rightarrow A \vdash A$  or  $\vdash ((\neg A) \rightarrow A) \rightarrow A$

- |   |              |
|---|--------------|
| (1) $(\neg A) \rightarrow ((A \rightarrow A) \rightarrow (\neg A))$   | $P_1$        |
| (2) $((\neg(\neg(A \rightarrow A)) \rightarrow (\neg A)) \rightarrow (\neg A)) \rightarrow (A \rightarrow (\neg(A \rightarrow A)))$ | $P_3$        |
| (3) $\vdash ((A \rightarrow A) \rightarrow (\neg A)) \rightarrow (\neg(\neg(A \rightarrow A)) \rightarrow (\neg A))$                | Exam. 2.15.2 |
| (4) $((A \rightarrow A) \rightarrow (\neg A)) \rightarrow (A \rightarrow (\neg(A \rightarrow A)))$                                  | HS(3, 2)     |
| (5) $(\neg A) \rightarrow (A \rightarrow (\neg(A \rightarrow A)))$  | HS(1, 4)     |
| (6) $\vdash ((\neg A) \rightarrow A) \rightarrow ((\neg A) \rightarrow (\neg(A \rightarrow A)))$                                    | Exam. 2.15.1 |
| (7) $(\neg A) \rightarrow A$  | Premise      |
| (8) $(\neg A) \rightarrow (\neg(A \rightarrow A))$  | MP(6, 7)     |
| (9) $((\neg A) \rightarrow (\neg(A \rightarrow A))) \rightarrow ((A \rightarrow A) \rightarrow A)$                                  | $P_3$        |
| (10) $(A \rightarrow A) \rightarrow A$  | MP(8, 9)     |
| (11) $\vdash A \rightarrow A$   | Exam. 2.11.1 |
| (12) $A$  | MP(10, 11)   |

**Example 2.15.4**

$A \rightarrow B, (\neg A) \rightarrow B \vdash B$  or  $\vdash (A \rightarrow B) \rightarrow (((\neg A) \rightarrow B) \rightarrow B)$

- |  |                  |
|--|------------------|
| (1) $A \rightarrow B$  | Premise          |
| (2) $(\neg A) \rightarrow B$   | Premise          |
| (3) $\vdash B \rightarrow (\neg(\neg B))$  | Exer. 2.11. 2(a) |
| (4) $(\neg A) \rightarrow (\neg(\neg B))$  | HS(2, 3)         |
| (5) $((\neg A) \rightarrow (\neg(\neg B))) \rightarrow ((\neg B) \rightarrow A)$ | $P_3$            |
| (6) $(\neg B) \rightarrow A$   | MP(4, 5)         |
| (7) $(\neg B) \rightarrow B$   | HS(6, 1)         |
| (8) $((\neg B) \rightarrow B) \rightarrow B$                                     | Exam. 2.15.3     |
| (9) $B$  | MP(7, 8)         |

The next two results completely relate  $\models$  and  $\vdash$ .

**Theorem 2.15.1** (Completeness Theorem) *If  $A \in L'$  and  $\models A$  (in  $L$ ), then  $\vdash A$ .*

Proof. Note that  $L' \subset L$ . Now assume  $A \in L'$  and  $\models A$ . We use an illustration that shows exactly how an explicit proof for  $\vdash A$  can be constructed. The process is a reduction process and this illustration can be easily extended to a formally stated reduction processes. Let  $P_1, P_2, P_3$  be the atoms in  $A$  and  $T = \vdash (P_i \rightarrow B) \rightarrow (((\neg P_i) \rightarrow B) \rightarrow B)$ . The ordering of the construction process is **0**, followed by **1**, then **2**, then **3** and finally followed by **4**. First, write down the formal steps that lead to each of the following deducibility relations and then construct, in each case using the Deduction Theorem, the forms **0**.

- |   |
|---|
| (1) $P_1, P_2, P_3 \vdash A \xrightarrow{\text{D.Thm}} \mathbf{0} \vdash P_1 \rightarrow (P_2 \rightarrow (P_3 \rightarrow A))$             |
| (2) $P_1, P_2, \neg P_3 \vdash A \xrightarrow{\text{D.Thm}} \mathbf{0} \vdash P_1 \rightarrow (P_2 \rightarrow ((\neg P_3) \rightarrow A))$ |
| (3) $P_1, \neg P_2, P_3 \vdash A \xrightarrow{\text{D.Thm}} \mathbf{0} \vdash P_1 \rightarrow ((\neg P_2) \rightarrow (P_3 \rightarrow A))$ |

- (4)  $P_1, \neg P_2, \neg P_3 \vdash A \stackrel{\text{D.Thm}}{\Rightarrow} \mathbf{0} \vdash P_1 \rightarrow ((\neg P_2) \rightarrow ((\neg P_3) \rightarrow A))$   
(5)  $\neg P_1, P_2, P_3 \vdash A \stackrel{\text{D.Thm}}{\Rightarrow} \mathbf{0} \vdash (\neg P_1) \rightarrow (P_2 \rightarrow (P_3 \rightarrow A))$   
(6)  $\neg P_1, P_2, \neg P_3 \vdash A \stackrel{\text{D.Thm}}{\Rightarrow} \mathbf{0} \vdash (\neg P_1) \rightarrow (P_2 \rightarrow ((\neg P_3) \rightarrow A))$   
(7)  $\neg P_1, \neg P_2, P_3 \vdash A \stackrel{\text{D.Thm}}{\Rightarrow} \mathbf{0} \vdash (\neg P_1) \rightarrow ((\neg P_2) \rightarrow (P_3 \rightarrow A))$   
(8)  $\neg P_1, \neg P_2, \neg P_3 \vdash A \stackrel{\text{D.Thm}}{\Rightarrow} \mathbf{0} \vdash (\neg P_1) \rightarrow ((\neg P_2) \rightarrow ((\neg P_3) \rightarrow A))$
- 1 Using (1) (5), insert  $\mathcal{T}$ , MP, MP (a)  $\Rightarrow \vdash P_2 \rightarrow (P_3 \rightarrow A)$   
1 Using (2) (6), insert  $\mathcal{T}$ , MP, MP (b)  $\Rightarrow \vdash P_2 \rightarrow ((\neg P_3) \rightarrow A)$   
1 Using (3) (7), insert  $\mathcal{T}$ , MP, MP (c)  $\Rightarrow \vdash (\neg P_2) \rightarrow (P_3 \rightarrow A)$   
1 Using (4) (8), insert  $\mathcal{T}$ , MP, MP (d)  $\Rightarrow \vdash (\neg P_2) \rightarrow ((\neg P_3) \rightarrow A)$
- 2 Using (a) (c), insert  $\mathcal{T}$ , MP, MP (e)  $\Rightarrow \vdash P_3 \rightarrow A$   
2 Using (b) (d), insert  $\mathcal{T}$ , MP, MP (f)  $\Rightarrow \vdash (\neg P_3) \rightarrow A$
- 3 Using (e) (f), insert  $\mathcal{T}$ , MP, MP  $\Rightarrow \vdash A$

Using this illustration, it follows that if  $P_1, P_2, \dots, P_k$  are the atoms in  $A$  and we let  $P_0 = A$ , then, using the  $2^k$  deducibility relations to obtain the combined steps that yield the statements  $\mathbf{0}$ , each of the steps of the form  $\mathbf{j} \leq k$ , will reduce the problem, by including additional steps, to one where only the forms  $\vdash P'_{k-j} \rightarrow (\dots(P'_k \rightarrow P_0)\dots)$  occur. In this case, each  $P'_m$ ,  $\mathbf{j} \leq m \leq k$ , will be either a  $P_m$  or a  $\neg P_m$  and reading from left-to-right will be, for each row of a standard truth table, the same forms  $P'_{k-j}, \dots, P'_k$  as constructed by Definition 2.14.2. After  $\mathbf{k}$  applications of this process we have a formal proof, without any need for the insertion of premises, that has the last step  $P_0 = A$ . ■

**Theorem 2.15.2** (Soundness Theorem) *If  $A \in L'$  and  $\vdash A$ , then  $\models A$ .*

Proof. Note that each instance of the axioms  $P_1, P_2, P_3$  is a valid formula. Also, we have that  $\models A$  and  $\models A \rightarrow B$ , then  $\models B$ . Thus at each step in the proof of  $\vdash A$ , we can insert correctly to the left of the formula the symbol  $\models$ . Since the last step in the proof is  $A$ , then we can correctly write  $\models A$ . ■

**Corollary 2.15.2.1** *Let  $\{A_1, \dots, A_n, A\} \subset L'$ . Then  $A_1, \dots, A_n \vdash A$  if and only if  $A_1, \dots, A_n \models A$ .*

Proof. By repeated application of deduction theorem and theorem 2.8.1 (a). ■

Due to these last two theorems, we can identify the connectives which we have used in  $L$  but not in  $L'$  with equivalent formula from  $L'$ . Hence define  $A \vee B$  by  $(\neg A) \rightarrow B$ ,  $A \wedge B$  by  $(\neg(A \rightarrow (\neg B)))$  and  $A \leftrightarrow B$  by  $(A \rightarrow B) \wedge (B \rightarrow A)$ .

There is a slight difference between the concept for  $L'$  we denote by  $\Gamma \vdash A$  and the concept  $\Gamma = \{A_1, \dots, A_n\} \models A$ . The concept  $\Gamma \vdash A$  includes the possibility that  $\Gamma$  is infinite not just finite. Shortly, we'll be able to extend  $\Gamma \models A$  to the possibility that  $\Gamma$  is infinite. Before we do this however, I can, at last, introduce you to the very first basic steps in the generation of a logical operator that mirrors a physical-like process that will create universes.

## 2.16 Consequence Operators

In set theory, if you are given a set of anything  $A$ , like a set of formula from  $L'$ , then another set is very easily generated. The set is denoted by  $\mathcal{P}(A)$ . This set is the set of all subsets of  $A$ . In the finite case, suppose that  $A = \{a, b, c\}$ . Letting  $\emptyset$  denote the empty set, then the set of all subsets of  $A$  is  $\mathcal{P}(A) = \{\emptyset, A, \{a\}, \{b\}, \{c\}, \{a, b\}, \{a, c\}, \{b, c\}\}$ . Notice that this set has 8 members. Indeed, if any set has  $n$  members, then  $\mathcal{P}(A)$  has  $2^n$  members. Obviously, if  $A$  is not finite, then  $\mathcal{P}(A)$  is not finite.

Most logical processes, like  $\vdash$ , satisfy a very basic set of process axioms. Notice that you can consider  $\Gamma \vdash B$  as a type of function. First, the entire process that yields a demonstration is done upon subsets of  $A$ . When the subset is  $\emptyset$ , you get a formal theorem. The set of ALL theorems or deductions from a give  $\Gamma$  is a subset of  $A$ . Let  $\Delta$  denote the set of all the deductions that can be obtained from  $\Gamma$  by our entire deductive process. Then can we get anything new  $B \notin \Delta$  by considering the premises  $\Gamma \cup \Delta$ ? Well, suppose we can and, of course,  $B$  is not a theorem. Then there is a finite set of formula from either  $\Gamma$  or  $\Delta$  that is used in the demonstration. Suppose that from  $\Delta$  you have  $D_1, \dots, D_m$ , where we may assume that these are not theorems and they are used in the proof. But each of these comes from a proof using members from  $\Gamma$ . So, just substitute for each occurrence of  $D_i$  its proof. Then you have a proof of  $B$  using only members of  $\Gamma$ . Thus you cannot get any more deductions by adjoining the set of all deductions to the original set of premises.

So, what have we determined about the  $\vdash$  process? Well, to express what we have learned mathematically, consider a function  $C$  with the domain the set of all premises. But, this is just  $\mathcal{P}(L')$ . Then the codomain, the set of all deductions  $\Delta$  is also a subset of  $\mathcal{P}(L')$ .

(1)  $C$  has as its domain  $\mathcal{P}(L')$  and its range is contained in  $\mathcal{P}(L')$ .

(2) Since a one step demonstration yields a premise, then for each  $\mathcal{B} \in \mathcal{P}(L')$ ,  $\mathcal{B} \subset C(\mathcal{B})$ .

(3) From the above discussion, for each  $\mathcal{B} \in \mathcal{P}(L')$ ,  $C(C(\mathcal{B})) = C(\mathcal{B})$ .

(4) Theorem 2.12.1 (f) or our above discussion states that if  $B \in C(\mathcal{A})$  then there exists a finite subset  $\mathcal{D}$  of  $\mathcal{A}$  such that  $B \in C(\mathcal{D})$ .

Any function that satisfies, (1), (2), (3), (4) is called a *consequence operator*. The important thing to know is that  $\vdash$  can be replace by such a consequence operator with additional axioms. For example, (5) for each  $A, B, C \in L'$ , the set of all  $P_1$ , the set of all  $P_2$ , and the set of all  $P_3$  form the set  $C(\emptyset)$ . Then (6) for each  $A \in \mathcal{P}(L')$ , if  $A, A \rightarrow B \in C(\mathcal{A})$ , then  $B \in C(\mathcal{A})$ .

What mirrors the physical-like behavior that creates a universe are very special type of consequence operators, one of which is denoted by  $*S$ . Operator  $*S$  is basically determined by a very simple logical process  $S$ . It's basis uses our description for  $\vdash$  including (6) (our MP). But a different set of axioms. These axioms are actually four very simple theorems from the language  $L'$  with the definition for  $\wedge$ . The completeness theorem tells us that they are theorems in  $\mathcal{P}(L')$ . Specifically, they are

(1)  $(A \wedge (B \wedge C)) \rightarrow ((A \wedge B) \wedge C)$ .

(2)  $((A \wedge B) \wedge C) \rightarrow (A \wedge (B \wedge C))$ .

(3)  $(A \wedge B) \rightarrow A$ .

(4)  $(A \wedge B) \rightarrow B$ .

It turns out that every know propositional deduction used throughout all the physical sciences, if they are different from the one we are studying, have (1) – (4) as theorems.

Consequence operator  $S$ , can be generated by the consequence operators  $S_n$ , where the only difference between  $S$  and  $S_n$  is that for  $S_n$  the MP step is restricted to level  $L'_n$ . Although for  $\mathcal{A} \in \mathcal{P}(L')$  if  $A \in S(\mathcal{A})$  there exists some  $n$  such that  $A \in S_n(\mathcal{A})$ , it is also true that for each  $n \geq 3$   $S_n(\mathcal{A}) \subset S(\mathcal{A})$  and  $S_n(\mathcal{A}) \neq S(\mathcal{A})$ . When a consequence operator like  $S_n$  has this property then  $S$  said to be *stronger than*  $S_n$ .

Now I can't go any further in discussing the very special consequence operator that generates a universe. Why? Since the language  $L'$  and the deductive process  $\vdash$  must be greatly expanded so that it is *more expressive*. Indeed, so that we can express almost everything within mathematics with our language. But,

after we have done this, then in the very last section of this book, I'll be able to show the mathematical existence of, at the least, one of these universe generating consequence operators.

---



---

**EXERCISE 2.16**

In the following, let  $C$  be a consequence operator defined on  $\mathcal{P}(L)'$ . See if you can give an argument that establishes the following additional consequence properties based, originally, upon the axioms.

1. Let  $\mathcal{A}, \mathcal{B}$  be two sets of premises taken from  $L'$ . Suppose that  $\mathcal{A} \subset \mathcal{B}$ . Show that  $C(\mathcal{A}) \subset C(\mathcal{B})$ .
2. Recall that  $\mathcal{A} \cup \mathcal{B}$ , the “union” set, is the set of all formula a formula  $A \in \mathcal{A} \cup \mathcal{B}$  if and only if  $A \in \mathcal{A}$  or  $A \in \mathcal{B}$ . Suppose that  $\mathcal{A} \cup \mathcal{B} \subset L'$ . Show that  $\mathcal{A} \subset C(\mathcal{B})$  if and only if  $C(\mathcal{A}) \subset C(\mathcal{B})$ .
3. Suppose that  $\mathcal{A} \cup \mathcal{B} \subset L'$ . Show that  $C(\mathcal{A} \cup \mathcal{B}) = C(\mathcal{A} \cup C(\mathcal{B})) = C(C(\mathcal{A} \cup C(\mathcal{B})))$ .

---



---

**Some other properties of idempotent operators.**

We use the consequence operator as our prototype. Recall that an operator  $C$  (function, map, etc.) is *idempotent* if for each  $X \in \mathcal{P}(L)$ ,  $C(C(X)) = C(X)$ .

Let  $S_1 = \{C(X) \mid X \in \mathcal{P}(L)\}$ ,  $S_2 = \{Y \mid Y = C(Y) \in \mathcal{P}(L)\}$ .

**Theorem 1.** *The sets  $S_1 = S_2$ .*

Proof. Let  $Y = C(X) \in S_1$ . Then  $Y \in \mathcal{P}(L)$  and  $Y = C(C(X)) = C(Y)$ . Thus  $Y \in S_2$ .

Conversely, let  $Y = C(Y) \in \mathcal{P}(L)$ . Then  $Y \in S_1$ . Hence,  $S_1 = S_2$ . ■

We can ask if  $C(X_1) = C(X_2)$ , does this matter? The answer is no since if  $Y = C(X_1) = C(X_2) = C(C(X_1)) = C(C(X_2)) = C(Y) \in S_2$ . There is a significant unification  $\mathcal{U}$  for any collection of physical theories The definition of  $\mathcal{U}$  required that we consider the set  $\{Y \mid X \subset Y = C_1(Y) = C_2(Y)\}$ .

Note the identity map  $I(X) = X$  for each  $X \in \mathcal{P}(L)$  is idempotent. (Indeed, a consequence operator if we are considering only these objects.) So, one can inquire as to when a given  $C$  has an inverse  $C^{\leftarrow} = C^{-1}$ . As usual  $C^{-1}$  is an inverse if  $C^{-1}(C(X)) = I(X)$ .

**Theorem 2.** *The idempotent operator  $C$  has an inverse if and only if  $C = I$ .*

Proof. Suppose that idempotent  $C$  has an inverse  $C^{-1}$ . Then for each  $X \in \mathcal{P}(L)$ ,  $X = I(X) = (C^{-1}C)(X) = C^{-1}(C(X)) = C^{-1}(C(C(X))) = (C^{-1}C)(C(X)) = I(C(X)) = C(X)$ . Thus, from the definition of the identity operator,  $C = I$ . ■

**Corollary 2.1.** *The only idempotent operator  $C$  that is one-to-one is the identity.*

This corollary is an interesting result for consequence operators since all science-community theories are generated by logic-systems which generate corresponding consequence operators. (You can find the definition of a logic-system in my published paper “Hyperfinite and standard unifications for physics theories,” *Internat. J. Math. Math. Sci.*, 28(2)(2001), 17-36 with an archived version at <http://www.arxiv.org/abs/physics/0105012>). So, for a the logic system used by any science-community, there are always two distinct sets of hypotheses  $X_1, X_2$  such that  $C(X_1) = C(X_2)$ .

Another example of idempotent operators are some matrices. Can we apply these notions to functions that take real or complex numbers and yield real or complex numbers? There is a result that states that the only non-constant idempotent linear real valued function defined on, at least,  $[b, d]$ ,  $b, 0, d > 0$  and continuous at  $c \in (b, d)$  is  $f(x) = x$ . Can you “prove” this? It also turns out in this case that if you want this identity form (i.e.  $f(x) = x$ ), then continuity at some  $x = c$  is necessary. In fact under the axiom of set theory called The Axiom of Choice, there is a function defined on all the reals that has either a rational



value or is equal to zero for each  $x$ , is, clearly, not constant, is linear, idempotent and not continuous for any real  $x$ . This makes it somewhat difficult to “graph.”

## 2.17 The Compactness Theorem.

With respect to  $\vdash$ , consistency is defined in the same manner as it was done for  $\models$ . We will use the defined connectives  $\wedge, \vee, \leftrightarrow$ .

**Definition 2.17.1** (Formal consistency.) A nonempty set of premises  $\Gamma$  is *formally consistent* if there does not exist a formula  $B \in L'$  such that  $\Gamma \vdash B \wedge (\neg B)$ .

For finite sets of premises  $\Gamma$  the Completeness and Soundness Theorems show that definition 2.17.1 is equivalent to consistency for  $\models$ . In the case of a set of finitely many premises, then all of the consistency results relative to  $\models$  can be transferred. But, what do we do when  $\Gamma$  is an infinite set of premises?

Well, we have used the assignment concept for finitely many premises. We then used the symbolism  $v(A, \underline{a})$  for the truth-value for  $A$  and the assignment to a finite set of atoms that includes the atoms in  $A$ . But if you check the proof in the appendix that such assignments exist in general, you'll find out that we have actually define a truth-value function on all the formula in  $L$ . It was done in such a manner, that it preserved all of the truth-value properties required for our connectives for  $L$ . Obviously, we could reduce the number of connectives and we would still be able to construct a function  $v$  that has a truth-value for each of the infinitely many atoms and preserves the truth-value requirements for the connectives  $\neg$  and  $\rightarrow$ . What has been proved in the appendix is summarized in the following rule.

**Truth-value Rule.** There exist truth-value functions,  $v$ , defined for each  $A \in L'$  such that for each atom  $A \in L'$ :

- (a)  $v(A) = T$  or  $v(A) = F$  not both.
- (b) For any  $A \in L'$ ,  $v(A) = T$  if and only if  $v(\neg A) = F$ .
- (c) For any  $A, B \in L'$ ,  $v(A \rightarrow B) = F$  if and only if  $v(A) = T$  and  $v(B) = F$ .
- (d) A truth-value function  $v$  will be called a *valuation* function and any such function is unique in the following sense. Suppose  $f$  and  $v$  are two functions that satisfy (a) and for each  $P \in L_0$   $f(P) = v(P)$ . Then if (b) and (c) hold for both  $f$  and  $v$ , then  $f = v$ .

Because of part (d) of the above rule, there are many different valuation functions. Just consider a different truth-value for some of the atoms in  $L_0$  and you have a different valuation function. In what follows, we let  $\mathcal{E}$  be the set of all valuation functions.

**Definition 2.17.2** (Satisfaction)

- (a) Let  $\Gamma \subset L'$ . If there exists a  $v \in \mathcal{E}$  such that for each  $A \in \Gamma$ ,  $v(A) = T$ , then  $\Gamma$  is *satisfiable*.
- (b) A formula  $B \in L'$  is a *valid consequence* of  $\Gamma$  if for every  $v \in \mathcal{E}$  such that for each  $A \in \Gamma$   $v(A) = T$ , then  $v(B) = T$ .

It's obvious that for finite sets of premises the definition 2.17.2 is the same as our previous definition (except for a simpler language). Thus we use the same symbol  $\models$  when definition 2.17.2 holds. The proofs of metatheorems for this extended concept of truth-values are slightly different than those for the finite case of assignments. Indeed, it would probably have been better to have started with this valuation process and not to have considered the finite assignment case. But, the reason I did not do this was to give you a lot a practice with the basic concepts within elementary mathematical logic so as to build up a certain amount of intuition. In all that follows, all of our formula variables are considered to be formula in  $L'$ . I remind you, that all of our previous results that used assignments hold for this extended concept of  $\models$  if the set of premises is a finite or empty set.

**Theorem 2.17.1**

- (a)  $\models A$  if and only if  $\{(\neg A)\}$  is not satisfiable.
- (b) A single formula premise  $\{A\}$  is consistent if and only if  $\not\vdash (\neg A)$ .
- (c) The Completeness Theorem is equivalent to the statement that “Every consistent formula is satisfiable.”
- (d) The set of premises  $\Gamma \models A$  if and only if  $\Gamma \cup \{(\neg A)\}$  is not satisfiable.
- (e) If the set  $\Gamma$  is formally consistent and  $C \in \Gamma$ , then  $\Gamma \not\vdash (\neg C)$ .

Proof. (a), (b), (c) are left as an exercise.

(d) First, let  $\Gamma \models A$ . Then there is a  $v \in \mathcal{E}$  such that  $v(C) = T$  for each  $C \in \Gamma$  but  $v(A) = F$ . This  $v(\neg A) = T$ . Hence,  $\Gamma \cup \{(\neg A)\}$  is satisfiable.

For the converse, assume that  $\Gamma \models A$ . Now assume that there exists some  $v \in \mathcal{E}$  such that  $v(C) = T$  for each  $C \in \Gamma$ . Then for each such  $v$   $v(A) = T$ . In this case,  $v(\neg A) = F$ . Now if no such  $v$  exists such that  $v(C) = T$  for each  $C \in \Gamma$ , then  $\Gamma$  is not satisfiable. Since these are the only two possible cases for  $\Gamma \cup \{(\neg A)\}$ , it follows that  $\Gamma \cup \{(\neg A)\}$  is not satisfiable.

(e) Assume that  $\Gamma$  is formally consistent,  $C \in \Gamma$  and  $\Gamma \vdash (\neg C)$ . This yields that  $\Gamma \vdash C$ . Now to the demonstration add the step  $\vdash (\neg C) \rightarrow (C \rightarrow A)$ . Then two MP steps, yields that  $\Gamma \vdash A$ . Since  $A$  is any formula, simply let  $A = D \wedge (\neg D)$ . Hence  $\Gamma \vdash D \wedge (\neg D)$ . This contradicts the consistency of  $\Gamma$ .

The important thing to realize is that to say that  $\Gamma$  is consistent says that no finite subset of  $\Gamma$  can yield a contradiction. But if  $\Gamma$  is not itself finite, then how can we know that no finite subset of premises will not yield a contradiction? Are there not just too many finite subsets to check out? We saw that if  $\Gamma$  is a finite set, then all it needs in order to be consistent is for it to be satisfiable due to the Corollary 2.15.2.1. The next theorem states that for infinite  $\Gamma$  the converse of what we really need holds. But, just wait, we will be able to show that certain infinite sets of premises are or are not consistent.

**Theorem 2.17.2** *The set  $\Gamma$  is formally consistent if and only if  $\Gamma$  is satisfiable.*

Proof. We show that if  $\Gamma$  is consistent, then it is satisfiable. First, note that we can number every member of  $L'$ . We can number them with the set of natural numbers  $\mathbb{N}$ . Let  $L' = \{A_i \mid i \in \mathbb{N}\}$  Now let  $\Gamma$  be given. We extended this set of premises by the method of induction. (An acceptable method within this subject.)

- (1) Let  $\Gamma = \Gamma_0$ .
- (2) If  $\Gamma_0 \cup \{A_0\}$  is consistent, then let  $\Gamma_1 = \Gamma_0 \cup \{A_0\}$ . If not, let  $\Gamma_1 = \Gamma_0$ .
- (3) Assume that  $\Gamma_n$  has been defined for all  $n \geq 0$ .
- (4) We now give the inductive definition. For  $n + 1$ , let  $\Gamma_{n+1} = \Gamma_n \cup \{A_n\}$  if  $\Gamma_n \cup \{A_n\}$  is consistent. Otherwise, let  $\Gamma_{n+1} = \Gamma_n$ .

It follows by the method of definition by induction, that the entire set of  $\Gamma_n$ s has been defined for each  $n \in \mathbb{N}$  and each of these sets contains the original set  $\Gamma$ . We now define that set  $\bar{\Gamma}$  as follows:  $K \in \bar{\Gamma}$  if and only if there is some  $m \in \mathbb{N}$  such that  $K \in \Gamma_m$ .

We show that  $\bar{\Gamma}$  is a consistent set. Suppose that  $\bar{\Gamma}$  is not consistent. Then for some  $C \in L'$  and finite a subset  $A_1, \dots, A_n$  of  $\bar{\Gamma}$ , it follows that  $A_1, \dots, A_n \vdash C \wedge (\neg C)$ . However, since  $\Gamma \subset \Gamma_1 \subset \Gamma_2 \subset \dots \subset \Gamma$  etc. and since  $A_1, \dots, A_n$  is a finite set, there is some  $\Gamma_j$  such that  $A_1, \dots, A_n$  is a subset of  $\Gamma_j$ . But this produces a contradiction that  $\Gamma_j$  is inconsistent. Thus  $\bar{\Gamma}$  is consistent.

We now show that it is the “largest” consistent set containing  $\Gamma$ . Let  $A \in L'$  and assume that  $\bar{\Gamma} \cup \{A\}$  is consistent. If  $A \in \Gamma$ , then  $A \in \bar{\Gamma}$ . If  $A \notin \Gamma$ , then we know that there is some  $k$  such that  $A = A_k$ . But  $\Gamma_k \cup \{A_k\} \subset \bar{\Gamma} \cup \{A_k\}$  implies that  $\Gamma_k \cup \{A_k\}$  is consistent. But then  $A_k \in \Gamma_{k+1} \subset \bar{\Gamma}$ . Hence,  $A \in \bar{\Gamma}$ . We need a few additional facts about  $\bar{\Gamma}$ .

(i)  $A \in \bar{\Gamma}$  if and only if  $\bar{\Gamma} \vdash A$ . (Such a set of formulas is called a *deductive system*.) First, the process  $\vdash$  yields immediately that if  $A \in \bar{\Gamma}$ , then  $\bar{\Gamma} \vdash A$ . Conversely, assume that  $\bar{\Gamma} \vdash A$ . Then  $F_1 \vdash A$  for a finite subset of  $\bar{\Gamma}$ . We show that  $\bar{\Gamma} \cup \{A\}$  is consistent. Assume not. Then there is some finite subset  $F_2$  of  $\bar{\Gamma}$  such that  $F_2 \cup \{A\} \vdash C \wedge (\neg C)$  for some  $A \in L'$ . Thus  $F_1 \cup F_2 \vdash C \wedge (\neg C)$ . But this means that  $\bar{\Gamma} \vdash C \wedge (\neg C)$ . This contradiction implies that  $\bar{\Gamma} \cup \{A\}$  is consistent. From our previous result, we have that  $A \in \bar{\Gamma}$ .

(ii) If  $B \in L'$ , then either  $B \in \bar{\Gamma}$  or  $(\neg B) \in \bar{\Gamma}$ . (When a set of premises has this property they are said to be a (*negation*) *complete set*.) From consistency, not both  $B$  and  $\neg B$  can be members of  $\bar{\Gamma}$

(iii) If  $B \in \bar{\Gamma}$ , then  $A \rightarrow B \in \bar{\Gamma}$  for each  $A \in L'$ .

(iv) If  $A \notin \bar{\Gamma}$ , then  $A \rightarrow B \in \bar{\Gamma}$  for each  $B \in L'$ .

(v) If  $A \in \bar{\Gamma}$  and  $B \notin \bar{\Gamma}$ , then  $A \rightarrow B \notin \bar{\Gamma}$ .

(Proofs of (ii) – (v) are left as an exercise.)

We now need to define an valuation on all of  $\bar{\Gamma}$ . Simple to do. Let  $v(A) = T$  if  $A \in \bar{\Gamma}$  and  $v(B) = F$  if  $B \notin \bar{\Gamma}$ . Well, does this satisfy the requirements of a valuation function? First, it is defined on all of  $L'$ ?

(a) By (ii), if  $v(A) = T$ , then  $A \in \bar{\Gamma}$  implies that  $(\neg A) \notin \bar{\Gamma}$ . Hence,  $v(\neg A) = F$ .

(b) From (iii) – (v), it follows that  $v(A \rightarrow B) = F$  if and only if  $v(A) = T$  and  $v(B) = F$ . Thus  $v$  is a valuation function and  $\bar{\Gamma}$  is satisfiable. But  $\Gamma \subset \bar{\Gamma}$  implies that  $\Gamma$  is satisfiable and the proof is complete.

Now to show that if  $\Gamma$  is satisfiable, then it is consistent. Suppose that  $\Gamma$  is satisfiable but not consistent. Hence there exists a finite  $F \subset \Gamma$  such that  $F \vdash C \wedge (\neg C)$  for some  $C \in L'$ . But then  $F \models C \wedge (\neg C)$ , by corollary 2.15.2.1 and is not satisfiable. Hence since  $F \subset \Gamma$ , then  $\Gamma$  is not satisfiable. This contradiction yields this result. ■

**Theorem 2.17.3** *The following statement are equivalent.*

(i) If  $\Gamma \models B$ , then  $\Gamma \vdash B$ . (*Completeness*)

(ii) If  $\Gamma$  is consistent, then  $\Gamma$  is satisfiable.

Proof. Assume that (i) holds and that  $\Gamma$  is consistent. If  $C \in \Gamma$ , then by theorem 2.17.1 part (e)  $\Gamma \not\vdash (\neg C)$ . By the contrapositive if (i), then  $\Gamma \models (\neg C)$ . But by (d) of theorem 2.17.1,  $\Gamma \cup \{(\neg(\neg C))\}$  is satisfiable. Let  $v$  be the valuation. Then  $v(A) = T$  for each  $A \in \Gamma$  AND  $v((\neg(\neg C))) = T$ . Hence,  $v(C) = T$ . Thus  $\Gamma$  is satisfiable.

Now assume that (ii) holds and let  $\Gamma \models B$ . Then by theorem 2.17.1 part (d)  $\Gamma \cup \{(\neg B)\}$  is not satisfiable. Hence  $\Gamma \cup \{(\neg B)\}$  is inconsistent. Consequently, there is some  $C$  such that  $\Gamma \cup \{(\neg B)\} \vdash C \wedge (\neg C)$ . By Corollary 2.15.2.1,  $C \wedge (\neg C) \vdash A$  for any  $A \in L'$ . So, let  $A = (\neg B) \rightarrow B$ . So, in the demonstration that  $\Gamma \cup \{(\neg B)\} \vdash C \wedge (\neg C) \vdash (\neg B) \rightarrow B$ , one MP step yields  $B$ . Thus  $\Gamma \vdash B$ . ■

From theorem 2.17.3, since (ii) holds, then the extended completeness theorem (i) holds. But it really seems impossible to show that an infinite  $\Gamma$  is inconsistent unless we by chance give a demonstration that  $\Gamma \vdash C \wedge (\neg C)$  or to show that it is consistent by showing that  $\Gamma$  is satisfiable. For this reason, the next theorem and others of a similar character are of considerable importance.

**Theorem 2.17.3** (Compactness) *A set of formulas  $\Gamma$  is satisfiable if and only if every finite subset of  $\Gamma$  is satisfiable.*

Proof. Assume that  $\Gamma$  is satisfiable. Then there is some  $v \in \mathcal{E}$  such that  $v(A) = T$  for each  $A \in \Gamma$ . Thus for any subset  $F$  of  $\Gamma$  finite or otherwise  $v(B) = T$  for each  $B \in F$ .

Conversely, assume that  $\Gamma$  is not satisfiable. Then from theorem 2.17.2,  $\Gamma$  is not consistent. Hence there is some  $C \in L'$  and finite  $F \subset \Gamma$  such that  $F \vdash C \wedge (\neg C)$ . By the soundness theorem,  $F \models C \wedge (\neg C)$ . Thus  $F$  is not satisfiable and the proof is complete. ■

**Corollary 2.17.4.1** *A set of premises  $\Gamma$  is consistent if and only if every finite subset of  $\Gamma$  is consistent.*

**Example 2.17.1** Generate a set of premises by the following rule. Let  $A_1 = (\neg A)$ ,  $A_2 = (\neg A) \wedge A$ ,  $A_3 = (\neg A) \wedge A \wedge A$ , etc. Then the set  $\Gamma = \{A_i \mid i \in \mathbb{N}\}$  is inconsistent since  $A_2$  is not satisfiable.

**Example 2.17.2** Generate a set of premises by the following rule. Let  $A_1 = P$ ,  $A_2 = P \vee P_1$ ,  $A_3 = P \vee P_1 \vee P_2, \dots, A_n = P \vee \dots \vee P_{n-1}$ . Then the set  $\Gamma = \{A_i \mid i \geq 1, i \in \mathbb{N}\}$  is consistent. For consider a nonempty finite subset  $\mathcal{F}$  of  $\Gamma$ . Then there exists a formula  $A_k \in \mathcal{F}$  (with maximal subscript) such that if  $A_i \in \mathcal{F}$ , then  $1 \leq i \leq k$ . Let  $v \in \mathcal{E}$  be a valuation such that  $v(P) = T$ . Obviously such a valuation exists. The function  $v$  also gives truth-values for all other members of  $\mathcal{F}$ . But all other formula in  $\mathcal{F}$  contain  $P$  and are composed of a formula  $B$  such that  $A_i = P \vee B$ ,  $2 \leq i \leq k$ . But  $v(P \vee B) = T$  independent of the values  $v(B)$ . Hence  $\mathcal{F}$  is satisfied and the compactness theorem states that  $\Gamma$  is consistent.

## EXERCISES 2.17

1. Prove properties (ii), (iii), (iv), (v) for  $\overline{\Gamma}$  as they are stated in the proof of theorem 2.17.2.
2. Prove statements (a), (b), (c) as found in theorem 2.17.1.
3. Use the compactness theorem and determine whether or not the following sets of premises are consistent.
  - (a) Let  $A \in L'$ . Now  $\Gamma$  contains  $A_1 = A \rightarrow A$ ,  $A_2 = (A \rightarrow (A \rightarrow A))$ ,  $A_3 = A \rightarrow (A \rightarrow (A \rightarrow A))$ , etc.
  - (b) Let  $A \in L'$ . Now  $\Gamma$  contains  $A_1 = A \rightarrow A$ ,  $A_2 = (\neg(A \rightarrow A))$ ,  $A_3 = A \rightarrow (\neg(A \rightarrow A))$  etc.
  - (c) Let  $A_1 = P_1 \leftrightarrow P_2$ ,  $A_2 = P_1 \leftrightarrow (\neg P_2)$ ,  $A_3 = P_2 \leftrightarrow P_3$ ,  $A_4 = P_2 \leftrightarrow (\neg P_3)$ , etc.

The consistency of the process (1)(2)(3)(4) used in Theorem 2.17.2

We do not need Theorem 2.17.2 if  $\Gamma$  is a non-empty finite set of premises since then Corollary 2.15.2.1 applies. However, what follows holds for any set of hypotheses. Clearly, if the process (1)(2)(3)(4) is consistent it is not an effective process since there are no rules given to determine, in a step-by-step process, when a set such as  $\Gamma \cup A$ , where  $A \notin \Gamma$ , is consistent. On the other hand, there are various ways to show convincingly that the process itself is consistent. This is done by the intuitive method of re-interpretation and modeling. Two examples are described below. Later it will be shown more formally that such statements that characterize such processes are consistent if and only if they have a set-theoretic model.

(A) Call any  $A \in L'$  a “positive formula” if the  $\neg$  symbol does not appear in the formula. Let  $\Gamma$  be a set of positive formula. Apply the process (1)(2)(3)(4) where we substitute for “consistent” the phrase “a set of positive formula.” Note that since we started with a set of positive formula, then we can determine whether the set  $\Gamma_n \cup \{A_n\}$  is a set of positive formula just by checking the one formula  $A_n$ . What has been done in this example is that the original process (1)(2)(3)(4) has been re-interpreted using a determining requirement that can actually be done or a requirement that most exist. The fact that an actual determination can be made in finite time is not material to the consistency of the process. All that is required is that each formula be either positive or negative, and not both. This re-interpretation is called a “model” for this process and

implies that the original process is consistent relative to our intuitive metalogic. This follows since if the process is not consistent, then a simple metalogical argument would yield that there is an actual formula in  $L'$  that is positive and not positive.\* All of this is, of course, based upon the acceptance that the processes that generated  $L'$  are also consistent.

(B) We are using certain simple properties of the natural numbers to study mathematical languages and logical processes. It is assumed that these natural number processes are consistent. Using this assumption, we have the following model that is relative to a few natural number properties. Interpret  $\Gamma$  as a set of even numbers and interpret each member of  $L'$  as a natural number. Substitute for “consistent” the phrase “is a set of even natural numbers.” Thus, all we need to do is to determine for the basic induction step is whether  $\Gamma_n \cup \{A_n\}$  is a set of even numbers. Indeed, all that is needed is to show that  $A_n$  can be divided by 2 without remainder, theoretically a finite process. This gives a model for this induction process relative to the natural numbers since a natural number is either odd or even, and not both. Hence, we conclude that the original process is consistent relative to our metalogic.

---

\* Formally, (1)  $B \wedge (\neg B) \equiv \neg(B \rightarrow B)$ . (2)  $\vdash (\neg(B \rightarrow B) \rightarrow ((B \rightarrow B) \rightarrow C_i))$ . (3)  $(B \rightarrow B) \rightarrow C_i$ . (4)  $\vdash B \rightarrow B$ . (5)  $C_i$ . Just take  $C_1 =$  “ $A$  is positive” and  $C_2 =$  “ $A$  is not positive.”

## NOTES

## Chapter 3 - PREDICATE CALCULUS

### 3.1 A First-Order Language.

The propositional language studied in Chapter 2 is a fairly expressive formal language. Unfortunately, we can't express even the most obvious scientific or mathematical statements by using only a propositional language.

**Example 3.1.1** Consider the following argument. Every natural number is a real number. Three is a natural number. Therefore, three is a real number.

The propositional language does not contain the concept of "every." Nor does it have a method to go from the idea of "every" to the specific natural number 3. Without a formal language that mirrors the informal idea of "every" and the use of the symbol "3" to represent a specific natural number, we can't follow the procedures such as those used in chapter 2 to analyze the logic of this argument. In this first section, we construct such a formal language. Accept for some additional symbols and rules as to how you construct new formula with these new symbols, the method of construction of language levels is exactly the same as used for  $L$  and  $L'$ . So that we can be as expressive as possible, we'll use the connectives  $\vee$ ,  $\wedge$ , and  $\leftrightarrow$  as they are modeled by the connectives  $\neg, \rightarrow$ . We won't really need the propositions in our construction. But, by means of a special technique, propositions can be considered as what we will call *predicates* with *constants inserted*. This will be seen from our basic construction. This construction follows the exact same pattern as definition 2.2.3. After the construction, I will add to the English language interpretations of definition 2.2.4 the additional interpretations for the new symbols.

---

**Definition 3.1** (The First-Order Language  $Pd$ )

(1) A nonempty set of symbols written, at the first, with missing pieces (i.e. holes in them). They look like the following, where the underlined portion means a place were something, yet to be described, will be inserted.

(a) The *1-place predicates*

$P(\underline{\quad}), Q(\underline{\quad}), R(\underline{\quad}), S(\underline{\quad}), P_1(\underline{\quad}), P_2(\underline{\quad}), \dots$

(b) The *2-place predicates*

$P(\underline{\quad}, \underline{\quad}), Q(\underline{\quad}, \underline{\quad}), R(\underline{\quad}, \underline{\quad}), S(\underline{\quad}, \underline{\quad}), P_1(\underline{\quad}, \underline{\quad}), P_2(\underline{\quad}, \underline{\quad}), \dots$

(c) The *3-place predicates*

$P(\underline{\quad}, \underline{\quad}, \underline{\quad}), Q(\underline{\quad}, \underline{\quad}, \underline{\quad}), R(\underline{\quad}, \underline{\quad}, \underline{\quad}), \dots$

(d) And so-forth, continuing, if necessary, through any  $n$ -place predicate, a symbol with a "(" followed by  $n$  "holes," where the underlines appear, followed by a ")".

(2) An infinite set of *variables*,  $V = \{x_1, x_2, x_3, \dots\}$ , where we let the symbols  $x, y, z, w$  represent *any* distinct members of  $V$ .

(3) A nonempty set of constants  $\mathcal{C} = \{c_1, c_2, c_3, c_4, \dots\}$  and other similar notation, where we let  $a, b, c, d$  represent distinct members of  $\mathcal{C}$ .

(4) We now use the stuff in (1), (2), (3) to construct a set of *predicates*,  $\mathcal{P}$ , which are the atoms of  $Pd$ . In each of the underlined places in (1), insert either a single variable from  $V$  or a single constant from  $\mathcal{C}$ . Each time you construct one of these new symbols, it is called a 1, 2,  $\dots$ ,  $n$ -place predicate. **The language  $Pd$  will use one or more of these predicates.**

(5) The non-atomic formula are constructed from an *infinite* set of connectives. The u-nary connective  $\neg$  and the previous binary connectives  $\vee, \wedge, \rightarrow, \leftrightarrow$ . You place these in the same positions, level for level, as in the construction of definition 2.2.3.

(6) Before every member of  $V$ , the variables, will be placed immediately to them left the symbol  $\forall$ . Then before every member of  $V$  will be placed immediately to the left the symbol  $\exists$ . This gives infinitely many symbols of the form  $\mathcal{U} = \{\forall x_1, \forall x_2, \forall x_3, \forall x_4, \dots\}$  and of the form  $\mathcal{E}\mathcal{X} = \{\exists x_1, \exists x_2, \exists x_3, \exists x_4, \dots\}$  where we use the symbols  $\forall x, \forall y, \forall x, \exists x, \exists y, \exists z$  and the like to represent *any* of these symbols. Each  $\forall x$  is called an *universal quantifier*, each  $\exists x$  is called an *existential quantifier*.

(7) Now the stuff constructed in (6) is an infinite set of  $n$ -ary operators that behavior in the same manner as does  $\neg$  relative to the method we used to construct our language.

(8) Although in an actual first-order language, we usually need only a few predicates and a few universal or existential quantifiers or a few constants, it is easier to simply construct the levels, after the first level that contains all the predicates, in the following manner using parentheses about the outside of every newly constructed formula each time a formula from level 2 and upward is constructed. Take every formula from the *preceding level* and place immediately to the left a universal quantifier, take the same formula from the previous level and put immediately to the left a existential quantifier, repeat these constructions for all of the universal and existential quantifiers. **Important: The formula to the right of the quantifier used for this construction is called the *scope of the quantifier*.** Now to the same formula from the preceding level put immediately to left the  $\neg$  in the same manner as was done in definition 2.2.3.

(9) Now following definition 2.2.3, consider every formula from the previous level and construct the formula using the binary connectives  $\vee, \wedge, \rightarrow, \leftrightarrow$  making sure you put parentheses about the newly formed formula. AND after a level is constructed with these connectives we adjoin the previous level to the one just constructed.

(10) The set of all formula you obtain in this manner is our language  $Pd$ .

(11) Any predicate that contains only constants in the various places behaves just like a proposition in our languages  $L$  and  $L'$  and can be considered as forming a propositional language. What we have constructed is an extension of these propositional languages.

(12) I point out that there are other both less formal and more formal ways to construct the language  $Pd$ .

**This is not really a difficult construction.**

**Example 3.1.1** (i) The following are predicates.  $P(x), P(c), P(x, c), Q(x, x), Q(c, c_1, z)$ .

(ii) The following are not predicates.  $P(), P(\_), P(P, Q), P(), Px, Pc$ .

(iii) The following are members of  $Pd$ .  $(P(c) \leftrightarrow Q(x)), (\forall xP(c)), (\exists yP(x)), (\forall xP(x, y)), (\neg(\forall xP(z))), (\exists x(\forall x(\exists y(\forall yP(c, d, w))))), ((\exists x(P(x) \leftrightarrow Q(d))))$ .

(iv) The following are not formula.  $P(\exists x), (\forall P(x)), (\forall cP(x)), (\exists x(\forall y)P(x, y)), ((P(d) \leftrightarrow Q(x)\exists x)$ .

As was done with the language  $L$ , we employ certain terminology to discuss various features of  $Pd$ . We employ, whenever possible, the **same definitions**. Each element of  $Pd$  is called a *formula*. The first level  $Pd_0$  is the set of all the *atoms*. Any member of  $Pd$  which is not an atom is called a *composite formula*. A formula expressed entirely in terms of atoms and connectives is called an *atomic formula*. We let, as usually, the symbols  $A, B, C, \dots$  be *formula variables* and represent arbitrary members of  $Pd$ .

If  $A \in Pd$ , then there is a smallest  $n$  such that  $A \in Pd_n$  and  $A \notin Pd_k$  for any  $k < n$ . The number  $n$  is the *size* of  $A$ . All the parenthesis rules, the common pair rules hold, where  $\forall x$  and  $\exists x$  behave like the  $\neg$ . However, the parentheses that form the predicates are never included in these rule processes.

The English language interpretation rules for the predicates and the quantifiers take on a well-know form, while the interpretation is the same for all the other connectives as they appear in 2.1. For the following, we utilize the *variable predicate forms*  $A(x)$  and the like. These may be thought of as 1-place



predicates for the moment. Since this interpretation is an inductive interpretation, where we interpret only the immediate symbol, we need not know the exact definition for  $A(x)$  at this time.

---

(i)  $[P(\underline{\quad})] : ] P(\underline{\quad}, \underline{\quad})] : [P(\underline{\quad}, \underline{\quad}, \underline{\quad})] :$

These are usually considered to be simple declarative sentences that relate various noun forms. In order to demonstrate this, we use the “blank” word notation where the blanks are to be understood by the “-” symbol and the “blanks” must be filled in with a variable or a constant. Here is a list of examples that may be interpreted as 1-place, 2-place, 3-place and 4-place predicates. “- is lazy.” “- is a man.” “- plays -.” “- is less than -.” “- > -.” “- plays - with -.” “- plus - equal -.” “- + - = -.” “- plays - with - at -.” “- + - + - = -.”

---

(ii) The constants  $C$  are interpreted as identifying “names” for an element of a domain, a proper name and the like, where if there is a common or required name such as “0,” “1,” or “sine,” then this common name is used as a constant.

---

(iii)  $[\forall x A(x)] :$

For all  $x$ ,  $[A(x)] :$

For every  $x$ ,  $[A(x)]$ .

Whatever  $x$  is  $[A(x)]$ .

For arbitrary  $x$ ,  $[A(x)] :$

For each  $x$ ,  $[A(x)]$ .

(Common language)

Everyone is  $[A(x)]$ .

$[A(x)]$  always holds.

Each one is  $[A(x)]$ .

Everything is  $[A(x)]$ .

---

(iv)  $[\exists x A(x)] :$

There exists an  $x$  such that  $[A(x)]$ .

For suitable  $x$ ,  $[A(x)]$ .

There is an  $x$  such that  $[A(x)]$ .

There is some  $x$  such that  $[A(x)]$ .

For at least one  $x$ ,  $[A(x)]$ .

(Common language)

At least one  $x$   $[A(x)]$ .

Someone is  $[A(x)]$ .

Something is  $[A(x)]$ .

---

Great care must be taken when considering a negation and quantification as is now demonstrated since a “not” before a quantifier or after a quantifier often yields different meanings.

---

(v)  $[\neg(\forall x A(x))] :$

Not for all  $x$ ,  $[A(x)]$ .

$[A(x)]$  does not always hold.

$[A(x)]$  does not hold for all  $x$ .

Not everything is  $[A(x)]$ .

---

(vi)  $[\forall x(\neg A(x))] :$

For all  $x$ , not  $[A(x)]$ .

$[A(x)]$  always fails.

Everything is not  $[A(x)]$ .

---

(vii)  $[\neg(\exists x A(x))] :$

There does not exist an  $x$  such that  $[A(x)]$ .

There does not exist any  $x$  such that  $\lceil A(x) \rceil$ .

There exists no  $x$  such that  $\lceil A(x) \rceil$ .

Nothing is  $\lceil A(x) \rceil$ .

There is no  $x$  such that  $\lceil A(x) \rceil$ .

No one is  $\lceil A(x) \rceil$ .

There isn't any  $x$  such that  $\lceil A(x) \rceil$ .

---

(viii)  $\lceil \exists x(\neg A(x)) \rceil$  :

For some  $x$ , not  $\lceil A(x) \rceil$ .

Something is not  $\lceil A(x) \rceil$ .

(All other  $\exists x$  with a not just prior to  $\lceil A(x) \rceil$ .)

There are many other possible English language interpretations for the symbols utilized within our first-order language but the ones listed above will suffice.

---

---

### EXERCISES 3.1

NOTE: Outer parenthesis simplification may have been applied.

1. Let  $A$  represent each of the following strings of symbols. Determine if  $A \in Pd$  or  $A \notin Pd$ .

(a)  $A = (\exists x(\neg(\forall xP(x, y))))$

(d)  $A = (P(c) \vee \exists x\forall yQ(x, y))$

(b)  $A = \forall x(P(x) \rightarrow (\exists cP(c, x)))$

(e)  $A = \exists x(\forall y(P(x) \rightarrow Q(x, y)))$

(c)  $\forall x(\exists y(\forall z(P(x))))$ .

2. Find the size of  $A$ .

(a)  $A = \exists x(\forall y(\exists zP(x, y, z)))$ .

(b)  $A = (P(c) \rightarrow (\exists y(\neg(\forall xP(x, y))))))$ .

(c)  $A = \forall x(P(x) \rightarrow ((\exists yP(x, y)) \rightarrow (P(c) \vee Q(c))))$

(d)  $A = (P(c) \vee (\exists y(Q(x) \rightarrow P(y)))) \rightarrow R(x, y, z)$ .

3. Use the indicated predicate symbols, which may appear in previous lettered sections, and any arithmetic symbols such as  $\_ + \_$  for "sum of  $\_$  and  $\_$ " or  $\_ < \_$  for " $\_$  is less than  $\_$ ," or  $\_ = \_$  for " $\_$  is equal to  $\_$ " and the like and translate the following into symbols from the language  $Pd$ . You may need to slightly re-write the English language statement into one with the same intuitive meaning prior to translation

(a) If the product of finitely many factors is equal to zero, then at least one of the factors is zero. [Let  $P(\_)$  be the predicate " $\_$  is the product of finitely many factors,"  $Q(\_, \_)$  be the predicate " $\_$  is a factor of  $\_$ ."] ]

(b) For each real number, there is a larger real number. [Let  $R(\_)$  be " $\_$  is a real number."]

(c) For every real number  $x$  there exists a real number  $y$  such that for every real number  $z$ , if the sum of  $z$  and 1 is less than  $y$ , then the sum of  $x$  and 2 is less than 4. [Note that " $\_ + 1 < \_$ " is a three place predicate with a constant "1" in the second place.] ]

(d) All women who are lawyers admire some judge. [Let  $W(\_)$  be " $\_$  is a women," let  $L(\_)$  be " $\_$  is a lawyer," let  $J(\_)$  be " $\_$  is a judge," and let  $A(\_, \_)$  be " $\_$  admires  $\_$ ."]

(e) There are both lawyers and shysters who admire Judge Jones. [Let  $S(\_)$  be " $\_$  is a shyster," and let  $j$  symbolize the name "Jones."]

(f) If each of two persons is related to a third person, then the first person is related to the second person. [Let  $R(\_, \_)$  be " $\_$  is related to  $\_$ ," and let  $P(\_)$  be " $\_$  is a person."]

(g) Every bacterium which is alive in this experiment is a mutation. [Let  $B(\_)$  be " $\_$  is a bacterium,"  $A(\_)$  be " $\_$  is alive in this experiment," and  $M(\_)$  be " $\_$  is a mutation."]

(h) The person responsible for this rumor must be both clever and unprincipled. [Let  $P(\_)$  be “– is a person responsible for this rumor,”  $C(\_)$  be “– is clever,” and  $U(\_)$  be “– is unprincipled.”]

(i) If the sum of three equal positive numbers is greater than 3 and the sum of the same equal positive numbers is less than 9, then the number is greater than 1 and less than 3.

(j) For any persons  $x$  and  $y$ ,  $x$  is a brother of  $y$  if and only if  $x$  and  $y$  are male, and  $x$  is a different person than  $y$ , and  $x$  and  $y$  have the same two parents. [Let (again)  $P(\_)$  be “– is a person,”  $B(\_, \_)$  be “– is a brother of –,”  $M(\_)$  be “– is a male,”  $\_ \neq \_$  be “– is a different person than –,”  $Q(\_, \_)$  be “– and – have the same two parents.”]

4. Let  $P(\_)$  be “– is a prime number,”  $E(\_)$  be “– is an even number,”  $O(\_)$  be “– is an odd number,”  $D(\_, \_)$  be “– divides –.” Translate each of the following formal sentences into English language sentences.

(a)  $P(7) \wedge O(7)$ .

(b)  $\forall x(D(2, x) \rightarrow E(x))$ .

(c)  $(\exists x(E(x) \wedge P(x))) \wedge (\neg(\exists x(E(x) \wedge P(x)))) \wedge (\exists y(x \neq y)) \wedge E(y) \wedge P(y)$ .

(d)  $\forall x(E(x) \rightarrow (\forall y(D(x, y) \rightarrow E(y))))$ .

(e)  $\forall x(O(x) \rightarrow (\exists y(P(y) \rightarrow D(y, x))))$ .

### 3.2. Free and Bound Variable Occurrences.

Prior to the model theory (the semantics) for the language  $Pd$ , a further important concept must be introduced. It’s interesting to note that the next concept dealing with variables took a considerable length of time to formulate in terms of an easily followed rule. As usual, we are fortunate that much of the difficult work in mathematical logic has been simplified so that we may more easily investigate these important notions. For simplicity, the  $n$ -place predicates where all places are filled with constants will act as if they are propositions. As will be seen, the presence of any quantifiers prior to such predicates will have NO effect upon their semantical meaning nor will such a case involve any additional nonequivalent formula in the formal deduction (proof theory) associated with  $Pd$ .

**Definition 3.2.1** (Scope of a quantifier.)

Assume that a quantifier is symbolized by  $Q$ . Suppose that  $Q$  appears in a formula  $A \in Pd$ . Then in that quantifier appears one and only one variable, say  $v \in \mathcal{V}$ . Immediately to the right of the variable  $v$ , two and only two mutually distinct symbols appear.

(1) A left parenthesis. If this is the case, then the subformula from that left parenthesis to its common pair parenthesis is called the *scope of that quantifier*.

(2) No parenthesis appears immediately on the right. In this case, the predicate that appears immediately on the right is called the *scope of that quantifier*.

In general, to identify quantifiers and scopes, the quantifiers are counted by the natural numbers from left to right. In what follows, we place the “quantifier” count as a subscript to the symbols  $\forall$  and  $\exists$  rather than as subscripts to the variables. Note: if the same quantifier occurs more than once, then it is counted more than once. Why? Because it is the location of the quantifier within a formula that is of first importance.

**Example 3.2.1**

(a) Let  $A = (\forall_1 x P(x)) \wedge Q(x)$ . Then the scope of quantifier (1) is the predicate  $P(x)$ .

(b) Let  $A = \exists_1 y (\forall_2 x (P(x, y) \rightarrow (\forall_3 z Q(x))))$ . The scope of the quantifier (1) is  $(\forall x (P(x, y) \rightarrow (\forall z Q(x))))$ . The scope for the quantifier (2) is  $(P(x, y) \rightarrow (\forall z Q(z)))$ . The scope for quantifier (3) is  $Q(x)$ .

(c) Let  $A = \forall_1 x (\forall_2 y (P(c) \rightarrow Q(x, y))) \leftrightarrow (\exists_3 x P(c, d))$ . Then the scope for quantifier (1) is  $(\forall y (P(c) \rightarrow Q(x, y)))$ . The scope for quantifier (2) is  $(P(c) \rightarrow Q(x, y))$ . The scope for quantifier (3) is  $P(c, d)$ .

(d) Let  $A = (\forall_1 x ((R(x) \wedge (\exists_2 x Q(x, y))) \rightarrow (\exists_3 y P(x, y)))) \rightarrow Q(x, z)$ . The scope of quantifier (1) is  $((R(x) \wedge (\exists x Q(x, y))) \rightarrow (\exists y P(x, y)))$ . The scope of quantifier (2) is  $Q(x, y)$ . The scope of quantifier (3) is  $P(x, y)$ . Notice that the second occurrence of  $Q(x, y)$  is not in the scope of any quantifier.

Once we have the idea of the scope firmly in our minds, then we can define the very important notion of the “free” or “bound” occurrence of variable. We must have the formula in atomic form to know exactly what variables behave in these two ways. This behavior is *relative to their positions* within a formula. We call the position where a variable or constant explicitly appears as an *occurrence* of that specific variable or constant with in a specific formula.

**Definition 3.2.2** (Bound or free variables)

(1) Every place a constant appears in a formula is called a *bound occurrence of the constant*.

(2) You determine the free or bound occurrences after the scope for each quantifier has been determined. You start the determination at level  $Pd_0$  and work your way up each level until you reach the level at which the formula first appears in  $Pd$ . This is the “size” level.

(3) For level  $Pd_0$  every occurrence of a variable is a free occurrence.

(4) For each succeeding level, an occurrence of a variable is a *bound* occurrence if that variable occurs in a quantifier or is not previously marked as a bounded occurrence in the scope of the quantifier.

(5) After all bound occurrences have been determined, than any occurrence of a variable that is not bound is called a *free* occurrence.

(6) A bound occurrence of a specific variable is determine by a quantifier in which the variable appears. This is called the *bounding quantifier*.

(7) Any variable that has a free occurrence within a formula is said to be *free in the formula*.

There are various ways to diagram the location of a specific variable and its bound occurrences. One method is a line diagram and the other is to use the quantifier number and the *same* number for each bound occurrence of the variable. I illustrate both methods. It turns out that for one concept the line diagram is the better of the two.

**Example 3.2.2** This is the example of the line diagram method of showing the location of each bound variable.

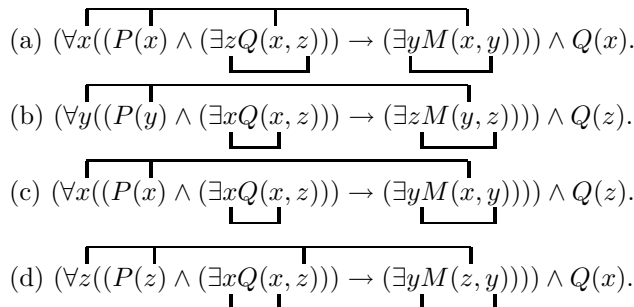

In these line diagrams, each vertical line segment attached to a line segment identifies the bound occurrences for a specific quantifier. Notice that in (a) the  $x$  has a bound occurrence and is free in the formula. Thus the concepts of free in a formula and bound occurrences are not mutually exclusive. In (b), the  $z$  has a bound occurrence and free in the formula. In (c),  $z$  is the only variable free in the formula. In (d),  $x$  has both a bound occurrence and is free in the formula.

**Example 3.2.3** The use of subscripts to indicate the bound occurrences of a variable AND its bounding quantifier.

$$(a) \forall x_1((P(x_1) \wedge (\exists z_2 Q(x_1, z_2))) \rightarrow (\exists y_3 M(x_1, y_3))) \wedge Q(x).$$

$$(b) \forall y_1((P(y_1) \wedge (\exists x_2 Q(x_2, z))) \rightarrow (\exists z_3 M(y_1, z_3))) \wedge Q(z).$$

The line diagram or number patterns themselves turn out to be of significance.

**Definition 3.2.3** (Congruent Formula) Let  $A, B \in Pd$  and  $A, B$  are in atomic form. Assume that all the bound occurrences of the variable in both  $A$  and  $B$  have been determined either by the line segment method or numbering method. If in both  $A$  and  $B$  all the bound variables and only the bound variables are erased and the remaining geometric form for  $A$  and for  $B$  are exactly the same (i.e. congruent), then the formula are said to be *congruent*.

The basic reason the concept of congruence is introduced is due to the following theorem. After the necessary machinery is introduced, it can be established. The  $\leftrightarrow$  that appears in this theorem behaves exactly as it does in the language  $L$ .

**Theorem 3.2.1** If  $A, B \in Pd$  and  $A, B$  are congruent, then  $\vdash A \leftrightarrow B$ .

**Example 3.2.3** In this example, we look at previous formula and determine whether they are congruent.

(a) In example 3.2.2, formula (a) is not congruent to (b) since the variable that occurs free in  $Q(\_)$  in (a) is  $x$  while the variable that occurs in  $Q(\_)$  in (b) is  $z$ .

(b) Formulas (b) and (c) in example 3.2 are congruent.

**Definition 3.2.4** (Sentences) Let  $A \in Pd$ . Then  $A$  is a *sentence* or *is a closed formula* if there are NO variables that are free in the formula  $A$ .

For this text, sentences will be the most important formula in  $Pd$ . Although one need not restrict investigations to sentences only, these other investigations are, usually, only of interest to logicians. Indeed, most elementary text books concentrate upon the sentence concept due to their significant applications. Further, you can always assign the concept of “truth” or “falsity” (occur or won’t occur) to sentences. The “always assign” in the last sentence does not hold for formula in general.

## EXERCISES 3.2

1. List the scope for each of the numbered quantifiers.

$$(a) (\forall_1 x (\exists_2 x Q(x, z))) \rightarrow (\exists_3 x Q(y, z)).$$

$$(b) (\exists_1 x (\forall_2 y (P(c) \wedge Q(y)))) \rightarrow (\forall_3 x R(x)).$$

$$(c) (P(c) \wedge Q(x)) \rightarrow (\exists_1 y (Q(y, z) \rightarrow (\forall_2 x R(x)))).$$

$$(d) \forall_1 z ((P(z) \wedge (\exists_2 x Q(x, z))) \rightarrow (\forall_3 z (Q(c) \vee P(z)))).$$

2. Use the subscript or line segment method to display the variables that are bound by a specific symbol  $\forall$  or  $\exists$ .

$$(a) (\forall z (\exists y (P(z, y) \wedge (\forall z Q(z, x))) \rightarrow M(z))).$$

$$(b) (\forall x (\exists y (P(x, y) \wedge (\forall y Q(y, x))) \rightarrow M(x))).$$

$$(c) (\forall z (\exists x (P(z, x) \wedge (\forall z Q(z, y))) \rightarrow M(z))).$$

$$(d) (\forall y (\exists z (P(y, z) \wedge (\forall z Q(z, x))) \rightarrow M(y))).$$

$$(e) (\forall y (\exists z (P(z, y) \wedge (\forall z Q(z, x))) \rightarrow M(y))).$$

- (f)  $\exists x(\forall z(P(x, z) \vee (\forall uM(u, y, x))))$ .
- (g)  $\exists y(\forall x(P(z, x) \vee (\forall xM(x, u, y))))$ .
- (h)  $\exists y(\forall x(P(y, x) \vee (\forall xM(x, y, z))))$ .
- (i)  $\exists z(\forall x(P(z, x) \vee (\forall xM(x, y, z))))$ .
- (j)  $\exists x(\forall x(P(z, x) \vee (\forall zM(x, y, z))))$ .

3. For the formula in [2] list as ordered pairs all formula that are congruent.

4. In the following formula, make a list as follows: write down the formula identifier, followed by the word “free,” followed by a list of the variables that are free in the formula, followed by the word “bound,” followed by the variables that have bound occurrences. (e.g. (g) Free,  $z, x, z$ ; Bound  $x, z$ .)

- (a)  $(P(x, y, z) \vee (\exists x(P(y) \rightarrow Q(x)))) \wedge (\forall zR(z))$ .
- (b)  $(\forall xP(x, x, x)) \rightarrow (Q(z) \wedge (\forall zR(z)))$ .
- (c)  $(\forall x(P(c) \wedge Q(x)) \rightarrow M(x)) \leftrightarrow P(y)$ .
- (d)  $(\forall x(\forall y(\forall z(P(x) \rightarrow Q(z)))) \vee Q(z)$ .
- (e)  $(P(c) \wedge Q(x)) \rightarrow ((\exists xQ(x)) \wedge (\exists y(Q(y, x) \rightarrow M(d))))$ .
- (f)  $\forall x(\exists y((P(x) \wedge Q(y)) \rightarrow (P(c) \wedge Q(c))))$ .

- 5. (a) Which formula in problem 1 are sentences?
- (b) Which formula in problem 2 are sentences?
- (c) Which formula in problem 4 are sentences?

### 3.3 Structures

In the discipline of mathematical logic, we use the simplest and most empirically consistent processes known to the human mind to study the human experience of communicating by strings of symbols and logical deduction. Various human abilities are necessary in order to investigate logical communication. One must be able to recognize that the symbols within the quotation marks “a” and “b” are distinct. Moreover, one must use various techniques of “ordering” in order to communicate in English and most other languages. An individual must intuitively know which string of symbols starts a communication and the direction to follow in order to obtain the next string of symbols. In the English language, this is indicated by describing the direction as from “left to right” and from “top to bottom.” Without a complete intuitive knowledge of these “direction concepts” no non-ambiguous English language communication can occur. These exact same intuitive processes are necessary in the mathematical discourse. Mathematics, in its most fundamental form, is based upon such human experiences.

In 1936, Tarski introduced a method to produce conceptually the semantical “truth” or “falsity” notion for a predicate language  $Pd$  that mirrors the concepts used for the propositional language  $L'$ . The Tarski ideas are informal in character, are based upon a few aspects of set-theory, but these aspects cannot be considered as inconsistent, in any manner, since by the above mentioned human abilities and experiences concrete symbol string examples can be given for these specific Tarski notions. The only possible difficulty with the Tarski concepts lies in the fact that in order for certain sentences in  $Pd$  to exhibit “truth” or “falsity,” the concept would need to be extended to non-finite sets. When this happens, some mathematicians take the view that the method is weaker than the method of the formalistic demonstration. In this case, however, most mathematicians believe that the Tarski method is not weaker than formal demonstrations since no inconsistency has occurred in using the most simplistic of the non-finite concepts. This simplistic non-finite

notion has been used for over 3,000 years. This non-finite notion is the one associated with the set called the natural numbers  $\mathbb{N}$ .

In this text, the natural numbers, beginning with zero, are considered as the most basic of intuitive mathematical objects and will not be formally discussed. This Tarski approach can be considerably simplified when restricted to the *set of all sentences*  $\mathcal{S}$ . It's this simplification that we present next.

We first need to recall some of the most basic concepts, concepts that appear even in many high school mathematics courses. Consider the following set of two alphabet letters  $A = \{a, a, b\}$ . First, the letters are not assumed to be in anyway different simply due to the left to right order in which they have been written or read. There is an "equality" defined for this set. Any two letters in this set are equal if they are intuitively the same letter. One sees two "a" symbols in this set. In sets that contain identifiable objects such as the two "a" symbols, it's an important aspect of set-theory that only one such object should be in the set. Hence, in general, specific objects in a set are considered as unique or distinct. On the other hand, variables can be used to "represent" objects. In this case, it makes sense to write such statements such as " $x = y$ ." Meaning that both of the variables "x" and "y" represent a unique member of the set under discussion.

In mathematical logic, another refinement is made. The set  $A$  need not be composed of just alphabet symbols. It might be composed of midshipmen. In this case, alphabet symbols taken from our list of constants are used to name the distinct objects in the set. Take an  $a \in C$ . In order to differentiate between this name for an object and the object it represents in a set, we use the new symbol  $a'$  to denote the actual object in the set being named by  $a$ .

Only one other elementary set-theory notion is necessary before we can define the Tarski method. This is the idea of the *ordered pair*. This is where, for the intuitive notion, the concept of left to right motion is used. Take any one member of  $A$ . Suppose you take  $a$ . Then the symbol  $(a, a)$  is an ordered pair. Using the natural number counting process, starting with 1, the set members between the left parenthesis "(" and the right parenthesis ")" are numbered. The first position, moving left to right, is called the *first coordinate*, the second position is called the *second coordinate*. In this example, both coordinates are equal under our definition of equality.

We can construct the set of ALL ordered pairs from the members in  $A$ . This set is denoted by  $A^2$  or  $A \times A$  and contains the distinct objects  $\{(a, a), (b, b), (a, b)(b, a)\}$ . What one needs to do is to use the equality defined for the set  $A$  to *define* an equality for ordered pairs. This can be done must easily by using a word description for this "ordered pair equality." Two ordered pairs are "equal" (which we denote by the symbol  $=$ ) if and only if the first coordinates are equal AND the second coordinates are equal.

Well, what has been done with two coordinates can also be done with 3, 4, 5, 25, 100, 999 coordinate positions. Just write down a left "(" a member of  $A$ , followed by a comma, a member of  $A$ , followed by a comma, continue the described process, moving left to right, until you have, say 999 coordinates but follow the last one in your symbol not by a comma but by a right ")". What this is called is a 999-tuple. The set of ALL 999-tuples so constructed from the set  $A$  is denoted by  $A^{999}$  rather than writing the symbol  $A$  999 times and putting  $998 \times$  symbols between them. For any natural number  $a$  greater than 1,  $A^n$  denotes the set of ALL n-tuples that can be constructed from the members of  $A$ .

Notice that we have defined equality of order pairs by using the coordinate numbers. To define equality for n-tuples, where  $n$  is any natural number greater than 1, simply extend the above 2-tuple (ordered pair) definition in terms of the position numbers. Thus two n-tuples are "equal" if and only if the first coordinates are equal AND the second coordinates are equal AND . . . AND the nth coordinates are equal.

The last set theory concept is the simple *subset* concept. A set  $B$  is a subset of the set  $A$  if and only if every object in  $B$  is in  $A$ , where this statement is symbolized by  $B \subset A$ . The symbols "in  $A$ " mean that you can recognize that the members of  $B$  are explicitly members of  $A$  by their properties. There is a special

set called the *empty set* (denoted by  $\emptyset$ ) that is conceived of as have NO members. From our definition for “subset,” the empty set is a subset of any set since the  $\emptyset$  contains no members and, thus, it certainly follows that all of its members are members of any set. Lastly, a subset  $R$  of  $A^n$ , for  $n > 1$ , will be called an  $n$ -place relation or an  $n$ -ary relation.

---

**Definition 3.3.1** (Structures) Let  $Pd$  be a first-order language constructed from a nonempty finite or infinite set  $\{P_1, P_2, \dots\}$  of predicates and an appropriate set  $C$  of constants that satisfies (iv). For our basic application, a *structure with an interpretation* is an object  $\mathcal{M} = \langle D, \{P'_1, P'_2, \dots\} \rangle$  where

- (i)  $D$  is a nonempty set called the *domain*.
- (ii) each  $n$ -place predicate  $P_i$ , where  $n > 1$ , corresponds to an  $n$ -place relation  $P'_i \subset D^n$ , and
- (iii) the 1-place predicates correspond to specific subsets of  $D$  and
- (iv) there is a function  $I$  that denotes the correspondence in (ii) and (iii) and that corresponds constants  $c_i \in N \subset C$  to members  $c'_i$  in  $D$ , (this function  $I$  is a naming function). Constants in  $N$  correspond to one and only one member in  $D$  and each member of  $D$  corresponds to one and only one member of  $N$ . Due to how axioms are stated, the structure symbol  $\mathcal{M} = \langle D, \{P'_1, P'_2, \dots\} \rangle$  may include a set of distinguished elements that correspond to distinguished constants in  $C$ . In this case, these constants are considered as contained in  $N$  and correspond under  $I$  to fixed members of  $D$ . [Only members of  $C$  appear in any member of  $Pd$ .]

The rule you use to obtain the correspondences between the language symbols and the set theory objects is called an *interpretation*. In general,  $\mathcal{M} = \langle D, \{P'_1, P'_2, \dots\} \rangle$  is a *structure* for various interpretations and includes distinguished elements.

---

**Example 3.3.1** Let our language be constructed from a 1-place predicate  $P$ , a 2-place predicate  $Q$  and two constants  $a, b$ . For the domain of our structure, let  $D = \{a', b', c'\}$ . Now correspond the one place predicate  $P$  to the subset  $\{a', b'\}$ . Let the 2-place predicate  $Q$  correspond to  $Q' = \{(a', a'), (a', b')\}$ . Finally, let  $a$  correspond to  $a'$  and  $b$  correspond to  $b'$ . The interpretation  $I$  can be symbolized as follows:  $I$  behaves like a simple function.  $I$  takes the atomic portions of our language and corresponds then to sets.  $I(P) = P'$ ,  $I(Q) = Q'$ ,  $I(a) = a'$ ,  $I(b) = b'$ ,  $a, b \in C$ .

Since the only members of  $Pd$  that will be considered as having a truth-value will be sentences, the usual definition for the truth-value for members in  $Pd$  can be simplified. A level by level inductive definition, similar to that used for the language  $L$  is used to obtain the truth-values for the respective sentences. This will yield a valuation function  $v$  that is dependent upon the structure.

There is one small process that is needed to define properly this valuation process. It is called the *free substitution operator*. We must know the scope of each quantifier and the free variables in the formula that is the scope.

---

**Definition 3.3.2** (Free substitution operator) Let the symbol  $S_\lambda^x$  have a language variable as the superscript and a language variable or language constant as a subscript. For any formula  $A \in Pd$ ,  $S_\lambda^x A$  yields the formula where  $\lambda$  has been substituted for every free occurrence of  $x$  in  $A$ .

---

**Example 3.3.2** Let  $A = \forall y(P(x, y) \rightarrow Q(y, x))$ .

- (i)  $S_y^x A = \forall y(P(y, y) \rightarrow Q(y, y))$
- (ii)  $S_x^x A = \forall y(P(x, y) \rightarrow Q(y, x))$ .
- (iii)  $S_c^x A = \forall y(P(c, y) \rightarrow Q(y, c))$ .

---

**Definition 3.3.3** (Structure Valuation for sentences). Given a structure  $\mathcal{M}$ , with domain  $D$ , for a language  $Pd$ .



(i) Suppose that  $P(\_, \dots, \_) \in Pd_0$  is an  $n$ -place predicate  $n \geq 1$ , that contains only constants  $c_i \in N$  in each of the places. Then  $\mathcal{M} \models P(c_1, \dots, c_n)$  if and only if  $(c'_1, \dots, c'_n) \in P'$ , where for any  $c_i \in N$ ,  $c'_i = I(c_i)$ , and constants that denote *special* required objects such as “0” or “1” and the like denote fixed members of  $D$  and are fixed members of  $D$  throughout the entire valuation process. Note that  $(c'_1) \in P'$  means that  $c'_1 \in P'$ . [Often in this case, such a set constants is said to “satisfy” (with respect to  $\mathcal{M}$ ), the predicate(s) or formula.] Since we are only interested in “modeling” sentences, we will actually let the “naming” subset  $N$  of  $C$  vary in such a manner such that  $I(N)$  varies over the entire set  $D$ .

(ii) If (i) does not hold, then  $\mathcal{M} \not\models P(c_1, \dots, c_n)$ .

(iii) Suppose that for a level  $m$ , the valuation  $\models$  or  $\not\models$  has been determined for formula  $A$  and  $B$ , and specific members  $c'_i$  of  $D$ .

(a)  $\mathcal{M} \not\models A \rightarrow B$  if and only if  $\mathcal{M} \models A$  and  $\mathcal{M} \not\models B$ . In all other cases,  $\mathcal{M} \models A \rightarrow B$ .

(b)  $\mathcal{M} \models A \leftrightarrow B$  if and only if  $\mathcal{M} \models A$  and  $\mathcal{M} \models B$ , or  $\mathcal{M} \not\models A$  and  $\mathcal{M} \not\models B$ .

(c)  $\mathcal{M} \models A \vee B$  if and only if  $\mathcal{M} \models A$  or  $\mathcal{M} \models B$ .

(d)  $\mathcal{M} \models A \wedge B$  if and only if  $\mathcal{M} \models A$  and  $\mathcal{M} \models B$ .

(e)  $\mathcal{M} \models (\neg A)$  if and only if  $\mathcal{M} \not\models A$ .

Take note again that any constants that appear in the original predicates have been assigned FIXED members of  $D$  and never change throughout this valuation for a given structure. In what follows,  $d$  and  $d'$  are used to denote arbitrary members of  $N$  and the corresponding members of  $D$ . Steps (f) and (g) below show how the various constants are obtained that are used for the previous valuations.

(f) For each formula  $C = \forall xA$ ,  $\mathcal{M} \models \forall xA$  if and only if for every  $d' \in D$  it follows that  $\mathcal{M} \models S_d^x A$ . Otherwise,  $\mathcal{M} \not\models \forall xA$ .

(g) For each formula  $C = \exists xA$ ,  $\mathcal{M} \models \exists xA$  if and only if there is some  $d' \in D$  such that  $\mathcal{M} \models S_d^x A$ . Otherwise,  $\mathcal{M} \not\models \exists xA$ .

(iv) Note that for 1-place predicate  $P(x)$  (f) and (g) say, that  $\mathcal{M} \models \forall xP(x)$  if and only if for each  $d' \in D$ ,  $d' \in P'$  and  $\mathcal{M} \models \exists xP(x)$  if and only if there exists some  $d' \in D$ , such that  $d' \in P'$ .

---

Please note that, except for the quantifiers, the valuation process follows that same pattern as the  $T$ s and  $F$ s follow for the truth-value valuation of the language  $L$ . Simply associate the symbol  $\mathcal{M} \models A$  with the  $T$  and the  $\mathcal{M} \not\models A$  with the  $F$ . Since every formula that is valuated is a sentence, we use the following language when  $\mathcal{M} \models A$ . The structure  $\mathcal{M}$  is called a *model* for  $A$  in this case. If  $\mathcal{M} \not\models A$ , then we say that  $\mathcal{M}$  is *not a model* for  $A$ . This yields the same logical pattern as the “occurs” or “does not occur” concept that can be restated as “as  $\mathcal{M}$  models” or “as  $\mathcal{M}$  does not model.” **Definition 3.3.3 is informally applied in that metalogical arguments are used relative to the informal notions of “there exists” and “for each” as they apply to members of sets.** For involved sentences, this process can be somewhat difficult.

In the appendix, it is shown that the process described in definition 3.3.3 is unique for every structure in the following manner. Once an interpretation  $I$  is defined, then all valuations that proceed as described in definition 3.3.3 yield the exact same results. Definition 3.3.3 is very concise. To illustrate what it means, let  $D = \{a', 0'\}$ ,  $A = P(x, y) \rightarrow Q(x)$  and  $P', Q' \in \mathcal{M}$ . It is determine whether  $\mathcal{M} \models P(a, 0)$ ,  $\mathcal{M} \models P(a, a)$ ,  $\mathcal{M} \models P(0, a)$ ,  $\mathcal{M} \models P(0, 0)$ ,  $\mathcal{M} \models Q(a)$ ,  $\mathcal{M} \models Q(0)$ . Now we use these results to determine whether  $\mathcal{M} \models \forall x(P(x, 0) \rightarrow Q(x))$ . This occurs only if  $\mathcal{M} \models P(a, 0) \rightarrow Q(a)$ ,  $\mathcal{M} \models P(0, 0) \rightarrow Q(0)$ , where we use the previous determinations.

**Example 3.3.3** (a) Let  $A = (\forall x(\exists yP(x, y))) \rightarrow (\exists y(\forall xP(x, y)))$ . Let the domain  $D = \{a'\}$  be a one element set. We define a structure for  $A = (\forall x(\exists yP(x, y))) \rightarrow (\exists y(\forall xP(x, y)))$ . Consider the 2-place relation

$P' = \{(a', a')\}$  and the interpretation  $I(P) = P'$ . As you will see later, one might try to show this by simply assuming that  $\mathcal{M} \models (\forall x(\exists yP(x, y)))$ . But this method will only be used where  $\mathcal{M}$  is not a specific structure. For this example, we determine whether  $\mathcal{M} \models (\forall x(\exists yP(x, y)))$  and whether  $\mathcal{M} \models (\exists y(\forall xP(x, y)))$  and use part (a) of definition 3.3.3. The valuation process proceeds as follows: first we have only the one statement that  $\mathcal{M} \models P(a, a)$ . Next, given each  $c' \in D$ , is there some  $d' \in D$  such that  $(c', d') \in P'$ ? Since there is only one member  $a'$  in  $D$  and  $(a', a') \in P'$ , then  $\mathcal{M} \models (\forall x(\exists yP(x, y)))$ . Now we test the statement  $\exists y(\forall xP(x, y))$ . Does there exist a  $c' \in D$  such that  $\mathcal{M} \models S_c^y \forall xP(x, y) = \forall xP(x, c)$ ; which continuing through the substitution process, does there exist a  $c' \in D$  such that for all  $d' \in D$  in  $(d', c') \in P'$ . The answer is yes, since again there is only one element in  $D$ . Thus  $\mathcal{M} \models \exists y(\forall xP(x, y))$ . Hence, part (v) (a) of definition 3.3.3 implies that  $\mathcal{M} \models A$ . Clearly, the more quantifiers in a formula the more difficult it may be to establish that a structure is a model for a sentence.

(b) A slighter weaker approach is often used. The informal theory of natural numbers is used as the basic mathematical theory for the study of logical procedures. It's considered to be a consistent theory since no contradiction has been produced after thousands of years of theorem proving. Thus a structure can be constructed from the theory of natural numbers. Let  $D = \mathbb{N}$  and there is two constants 1, 2 and one 3-placed relation  $P'$  defined as follows:  $(x, y, z) \in P'$  if and only if  $x \in \mathbb{N}$ ,  $y \in \mathbb{N}$  and  $z \in \mathbb{N}$  and  $x + y = z$ . Using the theory of natural numbers, one can very quickly determine whether  $\mathcal{M} \models A$  for various sentences.

Consider  $A = \forall xP(c_1, c_2, x)$ . Then let  $c_1 = 1$ ,  $c_2 = 2$ . [Note that the subscripts for the constants are not really natural numbers but are tick marks.] Now consider the requirement that for all  $a' \in \mathbb{N}$ ,  $\mathcal{M} \models P(1, 2, a)$ . Of course, since  $(1', 2', 5') \notin P'$ , then  $\mathcal{M} \not\models A$ . You will see shortly that this would imply that  $A$  is not valid.

(c) Using the idea from (b), the sentence  $\exists x \forall y P(x, y)$  has  $\mathcal{M} = \langle \mathbb{N}, \leq \rangle$  as a model. For there exists a natural number  $x = 0$  such that  $0 \leq y$  for each natural number  $y$ .

**Example 3.3.4** The following shows how the instructions for structure valuation can be more formally applied.

For  $\mathcal{M} = \langle D, P \rangle$ , let  $D = \{a', b'\}$ , and  $P' = \{(a', a'), (b', b')\}$ . we want to determine whether  $\mathcal{M} \models (\exists y(\forall xP(x, y))) \rightarrow (\forall x(\exists yP(x, y)))$ , and whether  $\mathcal{M} \models (\forall x(\exists yP(x, y))) \rightarrow (\exists y(\forall xP(x, y)))$  and also if  $\mathcal{M} \models \forall x(\exists xP(x, x))$ .

First we look at whether  $\mathcal{M} \models (\exists y(\forall xP(x, y)))$ . This means that first we establish that  $\mathcal{M} \models P(a, a)$ ,  $\mathcal{M} \not\models P(a, b)$ ,  $\mathcal{M} \models P(b, b)$ ,  $\mathcal{M} \not\models P(b, a)$ .

For the next stage we must determine whether (a)  $\mathcal{M} \models \forall xP(x, a)$ , (b)  $\mathcal{M} \models \forall xP(x, b)$ . Under the substitution requirement, for (a) that (i)  $\mathcal{M} \models P(a, a)$  and (ii)  $\mathcal{M} \models P(b, a)$ . However,  $\mathcal{M} \not\models P(b, a)$ . Thus for (a)  $\mathcal{M} \not\models \forall xP(x, a)$ . In the same manner, it follows that for (b)  $\mathcal{M} \not\models \forall xP(x, b)$ . Under the substitution requirement  $S_d^y \forall xP(x, y)$  produces the two formula  $\forall xP(x, a)$ ,  $\forall xP(x, b)$  and if one or the other or both satisfy  $\models$  then we know the  $\mathcal{M} \models$  holds. But, from (a) and (b) we know this is not the case so  $\mathcal{M} \not\models \exists y(\forall xP(x, y))$ . Now from our understanding of the  $\rightarrow$  connective this implies that  $\mathcal{M} \models (\exists y(\forall xP(x, y))) \rightarrow (\forall x(\exists yP(x, y)))$ .

Now consider  $\forall x(\exists yP(x, y))$ . The first step looks at  $\exists yP(a, y)$  and  $\exists yP(b, y)$ . In both cases, we have that  $\mathcal{M} \models \exists yP(a, y)$  and  $\mathcal{M} \models \exists yP(b, y)$ . Hence, we have that  $\mathcal{M} \models \forall x(\exists yP(x, y))$ . But this now implies that  $\mathcal{M} \not\models (\forall x(\exists yP(x, y))) \rightarrow (\exists y(\forall xP(x, y)))$ .

This is how one “thinks” when making and arguing for these valuations and you can actually make the substitution if  $D$  is a finite set and get a formula in  $Pd$ . The  $\forall$  can be replaced with a set of  $\wedge$  symbols, one for each member of  $D$  and the  $\exists$  can be replaced with a set of  $\vee$  symbols one for each member of  $D$ . It follows easily that  $\mathcal{M} \models \forall x(\exists yP(x, y))$  if and only if  $\mathcal{M} \models (P(a, a) \vee P(a, b)) \wedge (P(b, a) \vee P(b, b))$ .

What about  $\forall x(\exists xP(x,x))$ ? The substitution process says that under the valuation process this  $\forall x(\exists xP(x,x))$  is the same as  $\exists xP(x,x)$ . The valuation process is ordered, first we do the  $S_a^x P(x,x)$ . This gives under the first step the formulas  $P(a,a)$ ,  $P(b,b)$ . The second valuation process does not apply since there are no free variables in  $\exists xP(x,x)$ . The “or” idea for  $\exists$  yields that  $\mathcal{M} \models \forall x(\exists xP(x,x))$ .

We now change the structure to  $D = \{a', b'\}$ , and  $P' = \{(a', b'), (b', a')\}$  and interpret this as same before. One arrives at the same conclusions that  $\mathcal{M} \not\models (\exists y(\forall xP(x,y)))$  and that  $\mathcal{M} \models \forall x(\exists xP(x,y))$ . But, for this structure  $\mathcal{M} \not\models \forall x(\exists xP(x,x))$ . Hence, both structure are models for the sentences  $\mathcal{M} \models (\exists y(\forall xP(x,y))) \rightarrow (\forall x(\exists yP(x,y)))$ ,  $\forall x(\exists xP(x,x))$ . But for these three sentences, the second structure is only a model for  $\exists y(\forall xP(x,y)) \rightarrow (\forall x(\exists yP(x,y)))$ .

Note: A single domain and collection of n-place relations, in general, may have many interpretations. This follows from considering interpretations that use different members of  $D$  for the distinguished constants, if any, and the fact that any number of n-placed predicates can be interpreted as the same n-place relation. Thus for the above two structures if you have formula with five two-placed predicates, then you can interpret them all to be  $P'$ . However, if you are more interested in the logical behavior relative to a fixed structure, then in this case, such a formula with the five n-place predicates holds in this structure if and only if the sentence you get by replacing the five predicates with one predicate  $P(x,y)$  holds in the structure. [If you have different distinguished constants in these predicates they still are different in the place where you changed the predicate symbol name to  $P$ .] The obvious reason for this is that the actual valuation does not depend upon the symbol used to name the n-placed predicate (i.e. the  $P$ ,  $Q$ ,  $P_1$  etc.) but only on the function and the relation that interpretes the predicate symbol. For this reason, sometimes you will see the definition for an interpretation state that the correspondence between predicate symbols and relations be one-to-one.

### EXERCISES 3.3

1. In each of the following cases, write the formula that is the result of the substitution process.

- |   |   |
|---|---|
| (a) $S_a^x (\exists xP(x)) \rightarrow R(x,y)$                  | (d) $S_a^x S_b^x (\exists xP(x)) \rightarrow R(x,y)$                  |
| (b) $S_x^y (\exists yR(x,y)) \leftrightarrow (\forall xR(x,y))$ | (e) $S_a^x S_x^y (\exists yR(x,y)) \leftrightarrow (\forall xR(x,y))$ |
| (c) $S_a^y (\forall xP(y,x)) \wedge (\exists yR(x,y))$          | (f) $S_a^x S_b^y (\forall zP(y,x)) \wedge (\exists yR(x,y))$          |

2. Let  $A \in Pd$ . Determine whether the following is ALWAYS true or not. If the statement does not hold for all formula in  $Pd$ , then give an example to justify your claim.

- |                                       |                                       |
|---------------------------------------|---------------------------------------|
| (a) $S_a^x S_b^y A] = S_b^y S_a^x A]$ | (c) $S_y^x S_w^z A] = S_w^z S_y^x A]$ |
| (b) $S_x^x A] = S_x^x A]$             | (d) $S_x^x S_y^y A] = A$              |

3. Let  $D = \{a', b'\}$ , the 1-place relation  $P' = \{a'\}$  and the 2-place relation  $Q' = \{(a', a'), (a', b')\}$ . For each of the following sentences and interpretation of the constant  $c$ ,  $I(c) = a'$ , determine whether  $\mathcal{M} \models A$ , where  $\mathcal{M} = \langle D, a', P', Q' \rangle$ .

- (a)  $A = (\forall x(P(c) \vee Q(x,x))) \rightarrow (P(c) \vee \forall xQ(x,x))$ .  
 (b)  $A = (\forall x(P(c) \vee Q(x,x))) \rightarrow (P(c) \wedge \forall xQ(x,x))$ .  
 (c)  $A = (\forall x(P(c) \vee Q(x,x))) \rightarrow (P(c) \wedge \exists xQ(x,x))$ .  
 (d)  $A = (\forall x(P(c) \wedge Q(x,x))) \leftrightarrow (P(c) \wedge \forall xQ(x,x))$ .  
 (e)  $A = (\forall x(P(c) \wedge Q(c,x))) \leftrightarrow (P(c) \wedge \forall xQ(x,x))$ .

### 3.4 Valid Formula in $Pd$ .

Our basic goal is to replicate the results for  $Pd$ , whenever possible, that were obtained for  $L$  or  $L'$ . What is needed to obtain, at the least, one ultralogic is a compactness type theorem for  $Pd$ .

Since we are restricting the model concept to the set of sentences  $\mathcal{S}$  contained in  $Pd$ , we are in need of a method to generate the simplest sentence for formula that is not sentence. **Always keep in mind that fact that a structure is defined for all predicates and constants in a specific language  $Pd$ .** In certain cases, it will be necessary to consider special structures with special properties.

---

**Definition 3.4.1** (Universal closure) For any  $A \in Pd$ , with free variables  $x_1, \dots, x_n$ , (written in sub-script order the *universal closure* is denoted by  $\forall A$  and  $\forall A = \forall x_1(\dots(\forall x_n A)\dots)$ .

---

Obviously, if there are no free variables in  $A$ , then  $\forall A = A$ . In any case,  $\forall A \in \mathcal{S}$ . This fact will not be mentioned when we only consider members of  $\mathcal{S}$ . We will use the same symbol  $\models$ , as previously used, to represent the concept of a “valid” formula in  $Pd$ . It will be seen that it’s the same concept as the  $T$  and  $F$  concept for  $L$ .

---

**Definition 3.4.2** (Valid formula in  $Pd$ .) A formula  $A \in Pd$  is a *valid* formula (denoted by  $\models A$ ) if for every domain  $D$  and every structure  $\mathcal{M}$  with an interpretation  $I$  for each constant in  $A$  and each  $n$ -placed predicate in  $A$ ,  $\mathcal{M} \models \forall A$ .

---

A formula  $B$  is a *contradiction* if for every domain  $D$  and every structure  $\mathcal{M}$  with an interpretation  $I$  for each constant in  $A$  and each  $n$ -placed predicates in  $A$ ,  $\mathcal{M} \not\models \forall A$ .

---

We show that this is an extension of the valid formula concept as defined for  $L$ . Further, since every structure is associated with an interpretaion, this will be denoted by  $\mathcal{M}_I$ .

**Theorem 3.4.1** Let  $A, B, C \in \mathcal{S}$ . Suppose that  $\models A$ ;  $\models A \rightarrow B$ . Then  $\models B$ .

Proof. Suppose that  $\models A$  and  $\models A \rightarrow B$ . Let  $\mathcal{M}_I$  be any structure for  $Pd$ . From the hypothesis,  $\mathcal{M}_I \models A$  and  $\mathcal{M}_I \models A \rightarrow B$  imply that  $\mathcal{M}_I \models B$  from definition 3.3.3 (consider the size  $(A \rightarrow B) = m$ ) part (a). ■

In the metaproofs to be presented below, I will not continually mention the size of a formula for application of definition 3.3.3.

**Theorem 3.4.2** Let  $A, B, C \in \mathcal{S}$ . Then (i)  $\models A \rightarrow (B \rightarrow A)$ , (ii)  $\models (A \rightarrow (B \rightarrow C)) \rightarrow ((A \rightarrow B) \rightarrow (A \rightarrow C))$ , (iii)  $\models ((\neg A) \rightarrow (\neg B)) \rightarrow (B \rightarrow A)$ .

Proof. (i), (ii), (iii) follow in the same manner as does theorem 3.4.1 by restricting structures to specific formulas. Notice that every formula in the conclusions are members of  $\mathcal{S}$ . We establish (iii).

(iii) Let  $\mathcal{M}_I$  be a structure for  $Pd$ . Assume that  $\mathcal{M}_I \models (\neg A) \rightarrow (\neg B)$  for otherwise the result would follow from definition 3.3.3. Suppose that  $\mathcal{M}_I \models \neg A$  and  $\mathcal{M}_I \models \neg B$ . Hence from definition 3.3.3,  $\mathcal{M}_I \not\models A$  and  $\mathcal{M}_I \not\models B$ . Consequently,  $\mathcal{M}_I \models B \rightarrow A \Rightarrow \mathcal{M}_I \models ((\neg A) \rightarrow (\neg B)) \rightarrow (B \rightarrow A)$  from definition 3.3.3. Suppose that  $\mathcal{M}_I \not\models (\neg A)$ . Then  $\mathcal{M}_I \models A \Rightarrow \mathcal{M}_I \models B \rightarrow A$  and in this final case the result also holds. ■

**Theorem 3.4.3** Let  $A$  be any formal theorem in  $L$ . Let  $*A$  be obtained by substituting for each proposition  $P_i$  a member  $A_i \in \mathcal{S}$ . Then  $\models *A$ .

Proof. This follows in the exact same manner as the soundness theorem 2.15.2 for  $L'$  extended to  $L$  along with theorem 3.4.2. ■

**Theorem 3.4.4** Let  $A \in L$  and  $\models A$  as defined in  $L'$ . Then  $\models *A$  as defined for  $Pd$ .

Proof. This follows from the completeness theorem 2.15.1 for  $L'$  extended to  $L$  and theorem 3.4.3. ■

What theorems 3.4.2 and 3.4.4 show is that we have a great many valid formula in  $Pd$ . However, is this where all the valid formula come from or are there many valid formula in  $Pd$  that do not come from this simple substitution process?

**Example 3.4.1** Let  $A = P(x) \rightarrow (\exists xP(x))$ . Then  $\forall A = \forall x(P(x) \rightarrow (\exists xP(x)))$ . Let  $\mathcal{M}_I$  denote a structure for  $Pd$ . Suppose that  $\mathcal{M}_I \not\models \forall A$ . Then there is some  $d' \in D$  such that  $\mathcal{M}_I \not\models P(d) \rightarrow \exists xP(x)$ . Thus it must be that  $\mathcal{M}_I \models P(d)$  and  $\mathcal{M}_I \not\models \exists xP(x)$ . But this contradicts definition 3.3.3 (v) part (g). Thus  $\models P(x) \rightarrow (\exists xP(x))$ . It's relatively clear, due to the location of the  $\forall$  in the universal closure in the formula, that there is no formula  $B \in L'$  such that  $*B = \forall A$ .

There are many very important valid formula in  $Pd$  that are not obtained from theorems 3.4.2 and 3.4.4. To investigate the most important, we use the following *variable predicate* notation. Let  $A$  denote a formula from  $Pd$ . Then there are always three possibilities for an  $x \in \mathcal{V}$ . Either  $x$  does not appear in  $A$ ,  $x$  appears in  $A$  but is not free in  $A$ , or  $x$  is free in  $A$ . There are certain important formula, at least for the proof theory portion of this chapter, that are valid and that can be expressed in this general variable predicate language. Of course, when such metatheorems are established, you need to consider these three possibilities.

With respect to our substitution operator  $S_\lambda^x$ , if  $A$  either does not contain the variable  $x$  or it has no free occurrences of  $x$ , then  $S_\lambda^x A = A$ . Further it is important to note that the constant  $d$  that appears is a general constant that is relative to a type of extended interpretation where it corresponds to some  $d'$ . But it is not part of the original interpretation. This difference must be strictly understood.

---

**Definition 3.4.3** (Free for) Let  $A \in Pd$ . Then a variable  $v$  is *free for  $x$  in  $A$*  if the formula  $S_v^x A$ , at the least, has free occurrences of  $v$  in the same positions as the free occurrences of  $x$ .

---

**Example 3.4.2** Notice (i) that  $x$  is free for  $x$  in any formula  $A \in Pd$  and  $S_x^x A = A$ .

(ii) Further, if  $x$  does not occur in  $A$  or is not free in  $A$ , then any variable  $y$  is free for  $x$  in  $A$  and  $S_y^x A = A$  for any  $y \in \mathcal{V}$ . The only time one gets a different (looking) formula that *preserves free occurrences* through the use of the substitution operator  $S_\lambda^x A$  is when  $x$  is free in  $A$  and  $\lambda \in \mathcal{V}$  is free for  $x$  and  $\lambda \neq x$ .

(iii) Let  $A = \exists yP(y, x)$ . Then  $y$  is NOT free for  $x$  since  $S_y^x A = \exists yP(y, y)$ . You get a non-congruent formula by this application of the substitution operator.

(iv) But  $z$  is free for  $x$  since  $S_z^x A = \exists yP(y, z)$ .

(v) If  $A = (\exists xP(x, y)) \rightarrow (\exists yQ(x))$ , then  $y$  is NOT free for  $x$  since  $S_y^x A = (\exists xP(x, y)) \rightarrow (\exists yQ(y))$ . Again  $z$  is free for  $x$ .

**Theorem 3.4.5** For any formula  $A$  with variables  $x_1, x_2, \dots, x_n$  and only these free variables (where the subscripts only indicate the number of distinct variables and not their subscripts in the set  $\mathcal{V}$ ), then for any structure  $\mathcal{M}_I$ ,  $\mathcal{M}_I \models \forall A$  if and only if for each  $c'_1 \in D$  and for each  $c'_2 \in D$  and  $\dots$  and for each  $c'_n \in D$ ,  $\mathcal{M}_I \models S_{c'_1}^{x_1} S_{c'_2}^{x_2} \dots S_{c'_n}^{x_n} A$   $\dots$ ].

Proof. From the definition of universal closure and definition 3.3.3. ■

**Corollary 3.4.5.1** Under the same hypotheses as theorem 3.4.5,  $\mathcal{M}_I \models S_{c'_i}^{x_i} S_{c'_j}^{x_j} \dots S_{c'_k}^{x_k} A$   $\dots$ ]] for any permutation  $(i, j, \dots, k)$  of the subscripts.

**Theorem 3.4.6** Let  $y$  be free for  $x$  in  $A$ . Then  $S_d^y S_d^x A = S_d^x S_d^y A$ .

Proof. The major argument to establish most of our validity results is dependent upon a rewording of the substitution process. If there are any free occurrences of  $y$ , then  $x$  does not occur free at those places that  $y$  occurs free in  $A$ . Substituting  $d$  for these specific free occurrences can be done first. Then, each  $y$  obtained by substituting for a free  $x$ , due to the fact that  $y$  is free for  $x$ , can be changed to a  $d$  by simply substituting the  $d$  for the free occurrences  $x$ . This yields the left hand side of the equation where all free

occurrence of  $xs$  are changed to  $ys$ , any other free occurrence of  $y$  remains as it is, and then all the free occurrences of  $y$  are changed to  $d$ . ■

**Theorem 3.4.7** *Suppose that  $A \in Pd$  and  $y$  is free for  $x$  in  $A$ , then*

(i) *if  $x$  does not occur free in  $A$ , then for any structure  $\mathcal{M}_I$  for  $Pd$ ,  $\mathcal{M}_I \models \forall(\forall xA)$  if and only if  $\mathcal{M}_I \models \forall A$  if and only if  $\mathcal{M}_I \models \forall x(\forall A)$ .*

(ii) *If  $x$  does not occur free in  $A$ , then for any structure  $\mathcal{M}_I$  for  $Pd$ ,  $\mathcal{M}_I \models \forall(\exists xA)$  if and only if  $\mathcal{M}_I \models \forall A$  if and only if  $\mathcal{M}_I \models \exists x(\forall A)$*

(iii)  $\models (\forall xA) \rightarrow S_y^x A$

(iv)  $\models S_y^x A \rightarrow (\exists xA)$ .

Proof. (i) Let  $\mathcal{M}_I$  be a structure for  $Pd$ . Suppose that  $\mathcal{M}_I \models \forall(\forall xA)$ . Since  $x$  is not free in  $A$ , then from corollary 3.4.5.1,  $\mathcal{M}_I \models (\forall x\forall A) \Rightarrow \mathcal{M}_I \models \forall A$ , since under the substitution process there is no free  $x$  for the substitution.

Conversely, suppose that  $\mathcal{M}_I \models \forall A$ . Since  $x$  is not free in  $A$ , then again from corollary 3.4.5.1,  $\mathcal{M}_I \models \forall A \Rightarrow \mathcal{M}_I \models \forall(\forall xA)$  for the same reason.

(ii) This follows in the same manner as (i).

(iii) First suppose that  $x$  is not free in  $A$ . Then  $S_y^x A = A$ . Let  $\mathcal{M}_I$  be a structure  $Pd$  and consider the sentence  $\forall((\forall xA) \rightarrow A)$ . Suppose that  $\{x_1, \dots, x_n\}$  are free variables in  $A$ . From 3.4.5, we must show that  $\mathcal{M}_I \models S_{c_1}^{x_1} \dots S_{c_n}^{x_n}((\forall xA) \rightarrow A)$ , where  $c_j \in D$ . However, making the actual substitutions yields that  $S_{c_1}^{x_1} \dots S_{c_n}^{x_n}((\forall xA) \rightarrow A) = S_{c_1}^{x_1} \dots S_{c_n}^{x_n}(\forall xA) \rightarrow S_{c_1}^{x_1} \dots S_{c_n}^{x_n}A = \forall(\forall xA) \rightarrow \forall A$ . We need only suppose that  $\mathcal{M}_I \models \forall(\forall xA)$ . Then from (i),  $\mathcal{M}_I \models \forall A$ . But then  $\mathcal{M}_I \models \forall A \rightarrow \forall A$  from our definition 3.3.3.

Now assume that  $x$  is free in  $A$ . Note that  $x$  is not free in  $\forall xA$ , or in  $S_y^x A$ . There are free occurrences of  $y$  in  $S_y^x A$  and there may be free occurrences of  $y$  in  $\forall xA$ . Any other variables that occur free in  $\forall xA$ , or  $S_y^x A$  are the same variables. Considering the actual substitution process for  $\forall((\forall xA) \rightarrow S_y^x A)$  and using corollary 3.4.5.1, we can permute all the other substitution processes for the other possible free variables not  $y$  to be done “first.” When this is done the positions that the arbitrary  $ds$  take yield  $\forall xC$  and  $S_y^x C$ , where  $C$  contains the various symbols  $d$  in the place of the other possible free variables and that correspond to the  $d' \in D$ . Consider  $\forall y((\forall xA) \rightarrow S_y^x C)$ . The valuation process for each  $d' \in D$  yields  $S_{d'}^y((\forall xC) \rightarrow S_{d'}^x C) = (\forall xS_{d'}^y C) \rightarrow S_{d'}^y S_{d'}^x C = (\forall x(S_{d'}^y C)) \rightarrow S_{d'}^y S_{d'}^x C = (\forall xB) \rightarrow S_{d'}^y B$ , where  $B = S_{d'}^y C$ . Now simply assume that  $\mathcal{M}_I \models \forall xB$ . Then for all  $d' \in D$ ,  $\mathcal{M}_I \models S_{d'}^y B$ . From definition 3.3.3,  $d' \in D$ ,  $\mathcal{M}_I \models (\forall xB) \rightarrow S_{d'}^y B$ . Since  $d' \in D$  is arbitrary, we have as this point in the valuation  $\mathcal{M}_I \models \forall y((\forall xA) \rightarrow S_y^x C)$ . Multiple applications of metalogic generalization as the  $d$ 's associated with the other free variables vary over  $D$  completes the proof of part (iii) since  $\mathcal{M}_I$  is also arbitrary.

(iv) The same proof from (iii) for the case that  $x$  is not free in  $A$  holds for this case. Again in the same manner as in the proof of part (iii), we need only assume that  $\mathcal{M}_I$  is a structure for  $Pd$  and for the formula  $S_y^x C \rightarrow (\exists xC)$ ,  $x$  or  $y$  are the only free variables in  $C$  and  $y$  is free for  $x$ . Consider  $\forall y((S_y^x C) \rightarrow (\exists xC))$ . Then for arbitrary  $c' \in D$ ,  $S_{c'}^y(S_y^x C) \rightarrow (\exists xC) = S_{c'}^y(S_y^x C) \rightarrow S_{c'}^y \exists xC = S_{c'}^y S_{c'}^x C \rightarrow \exists x(S_{c'}^y C) = S_{c'}^y B \rightarrow \exists xB$ , where  $B = S_{c'}^y C$ . Now if  $\mathcal{M}_I \models \exists xB$ . Then there exists some  $d' \in D$  such that  $\mathcal{M}_I \models S_{d'}^y B$ . Hence, letting  $c' = d'$ , we have  $\mathcal{M}_I \models S_{c'}^y B \rightarrow \exists xB$ . On the other hand, if  $\mathcal{M}_I \not\models \exists xB$ , then for all  $d' \in D$ ,  $\mathcal{M}_I \not\models S_{d'}^y B$ . This implies that  $\mathcal{M}_I \not\models S_{c'}^y B$ . From definition 3.3.3,  $\mathcal{M}_I \models S_{c'}^y B \rightarrow (\exists xB)$ . Since  $c$  is arbitrary, then  $\mathcal{M}_I \models \forall y((S_y^x C) \rightarrow (\exists xC))$ . Again by multiple applications of generalization and since  $\mathcal{M}_I$  is an arbitrary structure, the result follows. ■

There are many formulas in  $Pd$  that are not instances of valid propositional formula that may be of interest to the pure logician. It's not the purpose of this text to determine the validity of a member of  $Pd$  that will not be of significance in replicating within  $Pd$  significant propositional metatheorems. However, certain

formula in  $Pd$  are useful in simplifying ordinary everyday logical arguments. The next two metatheorems relate to both of these concerns.

**Theorem 3.4.8** *If  $x$  is any variable and  $B$  does not contain a free occurrence of  $x$ , then*

(i) *Special process and notation  $\mathcal{M}_I \models A$ .*

(ii) *For any structure  $\mathcal{M}_I$  for  $Pd$ , let  $A$  have free variables  $x_1, \dots, x_n$ . Then  $\mathcal{M}_I \models \neg(\forall x_1, \dots, (\forall x_n A) \dots)$  if and only if  $\mathcal{M}_I \models (\exists x_1, \dots, (\exists x_n (\neg A)) \dots)$ .*

(iii) *If  $\mathcal{M}_I \models B \rightarrow A$ , then  $\mathcal{M}_I \models B \rightarrow (\forall x A)$ .*

(iv) *If  $\mathcal{M}_I \models A \rightarrow B$ , then  $\mathcal{M}_I \models (\exists x A) \rightarrow B$ .*

Proof. (i) To determine whether or not  $\mathcal{M}_I \models A$ , where  $A$  is not a sentence, we consider whether or not  $\mathcal{M}_I \models \forall A$ . First, corollary 3.4.5.1 indicates that the order, from left to right, in which we make the required substitution has no significance upon the whether or not  $\mathcal{M}_I \models \forall A$ . Note that after we write the, possibly empty, sequence of statements “for each  $d'_1$ , for each  $d'_2, \dots, \in D$ ” **the universal closure substitution operators**  $S_{d'_1}^{x_1}, S_{d'_2}^{x_2}, \dots$  **distribute over all of the fundamental connections**  $\vee, \wedge, \rightarrow, \leftrightarrow, \neg$ . [Note that one must carefully consider the statements “for each  $d'_1$ , for each  $d'_2, \dots, \in D$ .”] What happens is that when we have a variable that is not free in a subformula then the substitution process simply does not apply. Further if the statements “for each  $d'_1$ , for each  $d'_2, \dots, \in D$ ” still apply to the entire formula and substitution operators have not been eliminated, then we can go from basic subformula that contain a universal closure substitution operators to the left of each subformula back to a universal closure for the entire composite formula. After making these substitutions, we would have, depending upon the domain  $D$ , a large set of objects that now carry the d’s (or c’s) in various places and that act like sentences. If these sentences satisfy the requirements of  $\mathcal{M}_I \models$ , then by the metalogical axiom of generalization  $\mathcal{M}_I \models$  holds for the universally closed formula.

For example, consider the hypotheses of this theorem and the formulas  $B \rightarrow A$ , and  $B \rightarrow (\forall x A)$ . To establish the result in (iii),  $\mathcal{M}_I \models B \rightarrow A$  means  $\mathcal{M}_I \models \forall (B \rightarrow A)$ . Hence, we have the, possibly empty, sequence of statements for each  $d_1 \dots, d \in D$ ,  $\mathcal{M}_I \models S_{d_1}^{x_1} \dots S_d^x (B \rightarrow A)$  holds. The valuation can be rewritten as  $S_{d_1}^{x_1} \dots S_d^x B \rightarrow S_{d_1}^{x_1} \dots S_d^x A \Rightarrow S_{d_1}^{x_1} \dots B \rightarrow S_d^x (S_{d_1}^{x_1} \dots A) = B' \rightarrow S_d^x A'$ . For the valuation process  $B'$  acts like a sentence and  $A'$  acts like a formula with only one free variable,  $x$ . Thus, from our observation about the metalogical process for quantification over the members of  $D$ , if by simply consider  $B$  to be a sentence, and  $A$  to have, at the most, one free variable  $x$ , it can be shown that  $\mathcal{M}_I \models B \rightarrow \forall x A$ , then we have established, in general, that  $\mathcal{M}_I \models B \rightarrow \forall x A$ .

Thus, this type of argument shows that in many of our following arguments, relative to structures, we can reduce the valuation process to a minimum number of free variables that are present within a specific formula.

**From this point on, unless otherwise stated, we will ALWAYS assume that  $\mathcal{M}_I$  means a structure for  $Pd$  and  $\mathcal{M}_I \models A$  means  $\mathcal{M}_I \models \forall A$**

(ii) If we have no free variables in  $A$ , then we have nothing to prove. Assume that  $A$  has only one free variable  $x$ . Suppose that  $\mathcal{M}_I \models (\neg(\forall x A))$ . This implies that  $\mathcal{M}_I \not\models \forall x A$ . This means that there exists some  $d' \in D$  such that  $\mathcal{M}_I \not\models S_{d'}^x A$ . This implies that there exists some  $d' \in D$  such that  $\mathcal{M}_I \models (\neg S_{d'}^x A) = S_{d'}^x (\neg A)$ . Hence  $\mathcal{M}_I \models (\exists x (\neg A))$ . Now apply induction.

Note: As well be seen in the following proofs, other conclusions hold that are not expressed in (iii) or (iv). These restricted conclusions are presented since these are basic results even where the universal closure is not used.

(iii) By the special process, assume that  $B$  is a sentence and that  $A$  has at the most one free variable  $x$ . Let  $\mathcal{M}_I \models B \rightarrow A$ . If  $A$  has no free variables, then  $A$  and  $B$  are sentences. The statement that for each

$d' \in D$ ,  $\mathcal{M}_I \models B \rightarrow A$  and the statement for each  $d' \in D$ ,  $\mathcal{M}_I \models B \rightarrow S_d^x A = B \rightarrow A$  are identical and the result holds in this case.

Suppose that  $x$  is the only free variable in  $A$  and  $B$  is a sentence. Then  $\mathcal{M}_I \models B \rightarrow A$  means that, for each  $d' \in D$ ,  $\mathcal{M}_I \models S_d^x(B \rightarrow A) = B \rightarrow S_d^x A$ . This is but the valuation process for the formula  $B \rightarrow (\forall x A)$ . Hence  $\mathcal{M}_I \models B \rightarrow (\forall x A)$ . (Assume  $\mathcal{M}_I \models B$ . Then  $\mathcal{M}_I \models S_d^x A$  for each  $d' \in D$  implies  $\mathcal{M}_I \models \forall x A$ .)

(iv) Assume that  $B$  is a sentence and that  $A$  has, at the most, one free variable  $x$ . As was done in (iii), if  $x$  is not free in  $A$ , the result follows. Assume that  $x$  is free in  $A$  and that  $\mathcal{M}_I \models A \rightarrow B$ . Then this means that, for each  $d' \in D$ ,  $\mathcal{M}_I \models S_d^x(A \rightarrow B) = (S_d^x A) \rightarrow B$ . Hence, since  $D \neq \emptyset$ , that there exists some  $d' \in D$ , such that  $\mathcal{M}_I \models (S_d^x A) \rightarrow B$ . Consequently, by the special process,  $\mathcal{M}_I \models (\exists x A) \rightarrow B$ . This complete the proof.

[Note: Parts (iii) and (iv) above do not hold if  $B$  contains  $x$  as a free variable. For an example, let  $P(x) = A = B$ ,  $D = \{a, b\}$ ,  $P' = \{a\}$ . Assume that  $\mathcal{M}_I \models P(x) \rightarrow P(x)$ . Thus, for  $a$ ,  $\mathcal{M}_I \models S_a^x P(x) \rightarrow P(x) = P(a) \rightarrow P(a)$  and, in like manner,  $\mathcal{M}_I \models P(b) \rightarrow P(b)$ . Since  $\mathcal{M}_I \not\models P(b)$ , then  $\mathcal{M}_I \not\models \forall x P(x)$ . Hence, for the case  $d = a$ , we have that  $\mathcal{M}_I \not\models P(a) \rightarrow \forall x P(x) \Rightarrow \mathcal{M}_I \not\models \forall (P(x) \rightarrow \forall x P(x)) \Rightarrow \mathcal{M}_I \not\models P(x) \rightarrow \forall x P(x)$ .]

An important aspect of logical communication lies in the ability to re-write expressions that contain quantifiers into logically equivalent forms. The next theorem yields most of the principles for quantifier manipulation that are found in ordinary communication.

**Theorem 3.4.9** *For formulas  $A$ ,  $B, C$  the following are all valid formulas, where  $C$  does not contain  $x$  as a free variable.*

- (i)  $(\exists x(\exists y A(x, y)) \leftrightarrow (\exists y(\exists x A(x, y)))$ .
- (ii)  $(\forall x(\forall y A(x, y)) \leftrightarrow (\forall y(\forall x A(x, y)))$ .
- (iii)  $(\neg(\exists x A)) \leftrightarrow (\forall x(\neg A))$ .
- (iv)  $(\neg(\forall x A)) \leftrightarrow (\exists x(\neg A))$ .
- (v)  $(\exists x(A \vee B)) \leftrightarrow ((\exists x A) \vee ((\exists x B)))$ .
- (vi)  $(\forall x(A \wedge B)) \leftrightarrow ((\forall x A) \wedge (\forall x B))$ .
- (vii)  $(\forall x(C \vee B)) \leftrightarrow (C \vee (\forall x B))$ .
- (viii)  $(\exists x(C \wedge B)) \leftrightarrow (C \wedge (\exists x B))$ .

Proof. (i) This follows from Theorem 3.4.5 and the fact that the expression “there exists some  $d' \in D$  and there exists some  $c' \in D$ ” is metalogically equivalent to “there exists some  $c' \in D$  and there exists some  $d' \in D$ .” Consequently, for arbitrary  $\mathcal{M}_I \models$ , if  $\mathcal{M}_I \models (\exists x(\exists y A(x, y)))$ , then  $\mathcal{M}_I \models (\exists y(\exists x A(x, y)))$  and conversely.

(ii) This follows immediately by Corollary 3.4.5.1.

(iii) (Special process.) This follows from the assumption that  $x$  is the only possible free variable in  $A$ , the propositional equivalent  $\models \neg(\neg A) \leftrightarrow A$ , and theorem 3.4.8 part (ii).

(iv) Same as in (iii).

(v) (Special process.) We may assume that the only possible free variables in  $A \vee B$  is the variable  $x$ . Assume that for  $\mathcal{M}_I$ , an arbitrary structure and  $\mathcal{M}_I \models (\exists x(A \vee B))$ . Then there exists some  $d' \in D$  such that  $\mathcal{M}_I \models S_d^x(A \vee B) = (S_d^x A) \vee (S_d^x B)$ . Note that it does not matter whether the variable  $x$  is free or not in  $A$  or  $B$  since this still holds whether or not a substitution is made. Hence, there exists some  $d' \in D$  such that  $\mathcal{M}_I \models S_d^x A$  or there exists at the least the same  $d' \in D$  such that  $\mathcal{M}_I \models S_d^x B$ . Hence,  $\mathcal{M}_I \models ((\exists x A) \vee (\exists x B))$ . Now assume that  $\mathcal{M}_I \not\models \exists x(A \vee B)$ . Thus, there does not exist any  $d' \in D$  such that



$\mathcal{M}_I \models S_d^x(A \vee B)$ . This means there does not exist any  $d' \in D$  such that  $\mathcal{M}_I \models (S_d^x A) \vee S_d^x B$ . Therefore,  $\mathcal{M}_I \not\models ((\exists x A) \vee (\exists x B))$ . This result now follows.

(vi) Taking the proof of (v) and change the appropriate words and  $\vee$  to  $\wedge$  this proof follows.

(vii) (Special process.) Assume that  $C$  does not have  $x$  as a free variable and that  $B$  may contain  $x$  as a free variable. Further, it's assumed that there are no other possible free variables.  $\forall x(C \vee B)$  is a sentence. Let  $\mathcal{M}_I$  be an arbitrary structure. Assume that  $\mathcal{M}_I \models \forall x(C \vee B)$ . Then for each  $d' \in D$ ,  $\mathcal{M}_I \models S_d^x(C \vee B) = C \vee S_d^x B$ . Hence,  $\mathcal{M}_I \models C$  or for each  $d' \in D$ ,  $\mathcal{M}_I \models S_d^x B$ . Hence,  $\mathcal{M}_I \models (C \vee (\forall x B))$ . Then in like manner, since  $x$  is not free in  $C$ ,  $\mathcal{M}_I \models (C \vee (\forall x B)) \Rightarrow \mathcal{M}_I \models \forall x(C \vee B)$ . [Note that this argument fails if  $C$  and  $B$  both have  $x$  as a free variable. Since if  $\mathcal{M}_I \models \forall x(C \vee B)$ , then considering any  $d' \in D$  we have that  $\mathcal{M}_I \models S_d^x(C \vee B) = S_d^x C \vee S_d^x B \Rightarrow \mathcal{M}_I \models S_d^x C$  or  $\mathcal{M}_I \models S_d^x B$ . But both of these statements need not hold for a specific  $d' \in D$ . Thus we cannot conclude that  $\mathcal{M}_I \models \forall x C$  or  $\mathcal{M}_I \models \forall x B$ . ]

(viii) Left as an exercise. ■

Obviously, theorems such as 3.4.9 would be very useful if the same type of substitution for valid formula with the  $\leftrightarrow$  in the middle holds for  $Pd$  as it holds in  $L$  or  $L'$ . You could simply substitute one for the other in various places. Well, this is the case, just by simple symbolic modifications of the proofs of the metatheorems 2.6.1, 2.6.2, 2.6.3, and corollary 2.6.3.1. We list those results not already present as the following set of metatheorems for  $Pd$  and for reference purposes.

---

**Definition 3.4.4** ( $\equiv$  for  $Pd$ .) Let  $A, B \in Pd$ . Then define  $A \equiv B$  if and only if  $\models A \leftrightarrow B$ . [See note on page 138.]

---

**Theorem 3.4.10** *The relation  $\equiv$  is an equivalence relation.*

Proof. See note on page 38.

**Theorem 3.4.11** *If  $A, B, C \in Pd$  and  $A \equiv B$ , then  $C_A \equiv C_B$ .*

Proof. Let  $\models \forall(A \leftrightarrow B)$ . It can be shown that this implies  $\models \forall(C_A \leftrightarrow C_B)$ .

**Corollary 3.4.11.1** *If  $A, B, C \in Pd$  and  $A \equiv B$ , and  $\models C_A$ , then  $\models C_B$ .*

With respect to  $A$  being congruent to  $B$  recall that all the formula have the exact same form, the exact same free variables in the exact same places, and the bounded variables can take any variable name as long as the formula retain the same bound occurrence patterns. Hence, structure valuation would yield the same statement that either  $\models$  or  $\not\models$ , holds for  $A$  and  $B$ . Also see note on page 38

**Theorem 3.4.12** *Suppose that  $A, B \in Pd$  are congruent. Then  $A \equiv B$ .*

**Theorem 3.4.13** *Let  $A \equiv B$ . Then  $\mathcal{M}_I \models A$  if and only if  $\mathcal{M}_I \models B$ .*

Proof. From Definition 3.4.4, if  $A \equiv B$ , then  $\models \forall A \leftrightarrow \forall B$  if and only if  $\mathcal{M}_I \models A$  implies  $\mathcal{M}_I \models B$  and  $\mathcal{M}_I \models B$  implies  $\mathcal{M}_I \models A$ .

---

### EXERCISES 3.4

1. A formula  $A$  is said to be  $n$ -valid, where  $n$  is a natural number greater than 0, if for *any* structure  $\mathcal{M}_I$ , with the domain containing  $n$  and only  $n$  elements,  $\mathcal{M}_I \models A$ .

(a) Prove that  $A = (\forall x(\exists y P(x, y))) \rightarrow (\exists y(\forall x P(x, y)))$  is 1-valid.

(b) A *countermodel*  $\mathcal{M}_I$  must be used to show that a formula  $A$  is not valid. You must define a structure  $\mathcal{M}_I$  such that  $\mathcal{M}_I \not\models A$ . Show by countermodel that the formula  $A$  in (a) is not 2-valid.

2. For each of the following, determine whether the indicated variable  $\lambda$  is free for  $x$  in the given formula  $A$ .

(a)  $A = \forall w(P(x) \vee (\forall x P(x, y)) \vee P(w, x)); \lambda = y$ .

- (b)  $A$  is the same as in (a) but  $\lambda = w$ .  
(c)  $A = (\forall x(P(x) \vee (\forall yP(x, y)))) \vee P(y, x)$ ;  $\lambda = x$ .  
(d)  $A$  is the same as in (c) and  $\lambda = y$ .  
(e)  $A = (\forall x(\exists yP(x, y)) \rightarrow (\exists yP(y, y)))$ ;  $\lambda = y$ .  
(f)  $A = (\exists zP(x, z)) \rightarrow (\exists zP(y, z))$ ;  $\lambda = z$ .

3. For the formula in question 2, write  $S_{\lambda}^x A$  whenever, as given in each problem,  $\lambda$  is free for  $x$ .

4. Give a metaproof for part (viii) of theorem 3.4.9.

5. Determine whether the formula are valid.

- (a)  $Q(x) \rightarrow (\forall xP(x))$ .  
(b)  $(\exists xP(x)) \rightarrow P(x)$ .  
(c)  $(\forall x(P(x) \wedge Q(x))) \rightarrow ((\forall xP(x)) \wedge (\forall xQ(x)))$ .  
(d)  $(\exists x(\exists yP(x, y))) \rightarrow (\exists xP(x, x))$ .  
(e)  $(\exists xQ(x)) \rightarrow (\forall xQ(x))$ .

6. A formula  $A$  is said to be in *prenex normal form* if  $A = Q_1x_1(Q_2x_2(\cdots(Q_nx_n(A))\cdots))$ , where  $Q_i$ ,  $1 \leq i \leq n$  is one of the symbols  $\forall$  or  $\exists$ . The following is a very important procedure. Use the theorems in this or previous sections relative to the language  $L$  or  $Pd$  to re-write each of the following formula in a prenex normal form that is equivalent to the original formula. [Hint. You may need to use the congruency concept and change variable names. For example,  $\forall xP(x) \rightarrow \forall xQ(x) \equiv \forall xP(x) \rightarrow \forall yP(y) \equiv \forall y(\forall xP(x) \rightarrow Q(y)) \equiv \forall y(Q(y) \vee (\neg(\forall xP(x)))) \equiv \forall y(Q(y) \vee (\exists x(\neg P(x)))) \equiv \forall y(\exists x(Q(y) \vee (\neg P(x))))$ .]

- (a)  $(\neg(\exists xP(x))) \vee (\forall xQ(x))$ .  
(b)  $((\neg(\exists xP(x))) \vee (\forall xQ(x))) \wedge (S(c) \rightarrow (\forall xR(x))))$ .  
(c)  $\neg(((\neg(\exists xP(x))) \vee (\forall xQ(x))) \wedge (\forall xR(x)))$ .

#### NOTE

It is not the case that  $\models \forall(A \leftrightarrow B) \leftrightarrow ((\forall A) \leftrightarrow (\forall B))$ . Let  $D = \{a', b'\}$ ,  $P' = \{a'\}$ ,  $Q' = \{b'\}$ . Then  $\mathcal{M}_I \not\models \forall x\forall y(P(x) \leftrightarrow Q(y))$  since  $\mathcal{M}_I \not\models P(a) \leftrightarrow Q(a)$ . However, since  $\mathcal{M}_I \not\models P(b)$  implies that  $\mathcal{M}_I \models \forall xP(x)$  and  $\mathcal{M}_I \not\models Q(a)$  implies that  $\mathcal{M}_I \models \forall yQ(y)$ , then  $\mathcal{M}_I \models (\forall xP(x)) \leftrightarrow (\forall yQ(y))$ .

Using material yet to come, a way to establish Theorems 3.4.10 and 3.4.11 is to use the soundness and completeness theorem, the usual reduced language  $Pd'$ , and 14.7, 14.9 that appear in J.W. Robbin, *Mathematical Logic a first course*, W. A. Benjamin, Inc NY (1969) p. 48. I note that these results are established in Robbin by use of formal axioms and methods that are identical with the ones presented in the next section. [The fact that the definition of  $\equiv$  via the universal closure is an equivalence relation follows from the fact that for any formula  $C$ ,  $\vdash (\forall C) \rightarrow C$  and  $\vdash \forall(A \leftrightarrow B)$  if and only if  $\vdash A \leftrightarrow B$ . Also  $\vdash \forall(A \leftrightarrow B) \rightarrow (\forall A) \leftrightarrow (\forall B)$  implies that if  $\models \forall(A \leftrightarrow B)$ , then  $\models (\forall A) \leftrightarrow (\forall B)$ . From  $\vdash \forall(A \leftrightarrow B) \rightarrow (C_A \leftrightarrow C_B)$ , if  $\models \forall(A \leftrightarrow B)$ , then  $\vdash (C_A \leftrightarrow C_B)$  implies  $\vdash \forall(C_A \leftrightarrow C_B)$  implies  $\models \forall(C_A \leftrightarrow C_B)$  implies  $C_A \equiv C_B$ . Using  $\vdash \forall(C_A \leftrightarrow C_B) \rightarrow ((\forall C_A) \leftrightarrow (\forall C_B))$ , we have that if  $A \equiv B$ , and  $\mathcal{M}_I \models C_A$ , then  $\mathcal{M}_I \models C_B$ . The fact that for congruent  $A$  and  $B$  that  $A \equiv B$  also follows from  $\vdash A \leftrightarrow B$ . ]

### 3.5 Valid Consequences and Models

As in the case of validity, the (semantical) definition for the concepts of a valid consequence and satisfaction are almost identical to those used for the language  $L$ .

**Definition 3.5.1** (Valid consequence for  $Pd$ .) A sentence  $B$  in  $Pd$  ( i.e.  $B \in \mathcal{S}$ ) is a *valid consequence* of a set of premises  $\Gamma \subset \mathcal{S}$ , which may be an empty set, if for any  $\mathcal{M}_I$  for  $\Gamma \cup \{B\}$  whenever  $\mathcal{M}_I \models A$  for each

$A \in \Gamma$ , then  $\mathcal{M}_I \models B$ . This can be most easily remembered by using the following notation. Let  $\Gamma \subset \mathcal{S}$ . Let  $\mathcal{M}_I \models \Gamma$  mean that  $\mathcal{M}_I \models A$  for each  $A \in \Gamma$ . Then  $B$  is a valid consequence from  $\Gamma$  if whenever  $\mathcal{M}_I \models \Gamma$ , then  $\mathcal{M}_I \models B$ , it being understood that  $\mathcal{M}_I$  is a structure for the set  $\Gamma \cup \{B\}$ . The notation used for valid consequence is  $\Gamma \models B$ .

---

The concept of “satisfaction” also involves models and we could actually do without this additional term.

---

**Definition 3.5.2** (Satisfaction for *Pd*) A  $\Gamma \subset \mathcal{S}$  is *satisfiable* if there exists a  $\mathcal{M}_I$  such that  $\mathcal{M}_I \models \Gamma$ .  $\Gamma$  is not satisfiable if no such structure exists.

---

As in the previous section, all of the results of section 2.8, 2.9 and 2.10 that hold for  $L$  also hold for this concept extended to *Pd*. The following metatheorem contains processes that are not used in the metaproof of its corresponding  $L$  language metatheorem. The remaining metatheorems follow in a manner very similar to their counterparts in sections 2.8 — 2.10.

**Theorem 3.5.1** (*Substitution into valid consequences.*) Let  $A_n, C, B \in \mathcal{S}$ .

(i) If  $A_n \equiv C$ , and  $A_1, \dots, A_n, \dots \models B$ , then  $A_1, \dots, A_{n-1}, C, \dots \models B$ .

(ii) If  $B \equiv C$ , and  $A_1, \dots, A_n, \dots \models B$ , then  $A_1, \dots, A_n, \dots \models C$ .

Proof. (i) Suppose that  $A_n \equiv C$ . Let  $\mathcal{M}_I$  be a structure. The  $\mathcal{M}_I$  is defined for  $C, B, A_1, \dots, A_{n-1}, A_n, \dots$ . Suppose that  $\mathcal{M}_I \models A_i$  for  $1 \leq i$ . Then  $\mathcal{M}_I \models B$ . But  $\mathcal{M}_I \models A_n$  if and only if  $\mathcal{M}_I \models C$ . Consequently, if  $\mathcal{M}_I \models \{A_1, \dots, A_{n-1}, C, \dots\}$ , then  $\mathcal{M}_I \models B$ . [Notice that these statements are conditional. If for any structure  $\mathcal{M}_I$  you get for any sentence  $A$  in the set of premises that  $\mathcal{M}_I \not\models A$  you can simply disregard the structure.]

(ii) Suppose that  $\mathcal{M}_I$  is a structure and that  $\mathcal{M}_I$  is defined for  $B, C, A_1, \dots, A_n, \dots$ . If  $\mathcal{M}_I \models A_i$  for  $1 \leq i$ , then  $\mathcal{M}_I \models B$ . But  $\mathcal{M}_I \models C$ . From this the result follows. ■

**Theorem 3.5.2** (*Deduction theorem*) Let  $A, B, A_i \in \mathcal{S}$  for  $1 \leq i \leq n$ .

(i)  $A \models B$  if and only if  $\models A \rightarrow B$ .

(ii)  $A, \dots, A_n \models B$  if and only if  $\models A_1 \wedge \dots \wedge A_n \rightarrow B$ .

(iii)  $A, \dots, A_n \models B$  if and only if  $\models (A_1 \wedge \dots \wedge A_n) \rightarrow B$ .

(iv)  $A, \dots, A_n \models B$  if and only if  $\models (A_1 \rightarrow \dots \rightarrow (A_n \rightarrow B) \dots)$ .

As with the language  $L$ , consistency is of major importance. It is defined by the model concept. The metatheorems that follow the next definition are established the same manner as their counterparts for  $L$ .

---

**Definition 3.5.3** (Consistency) A nonempty set of premises  $\Gamma \subset \mathcal{S}$  is *consistent* if there does not exist a  $B \in \mathcal{S}$  such that  $\Gamma \models B \wedge (\neg B)$ .

---

**Theorem 3.5.4** If  $B \in \mathcal{S}$ , then  $\not\models B \wedge (\neg B)$ .

**Theorem 3.5.5** A nonempty finite set of premises  $\Gamma \subset \mathcal{S}$  is *inconsistent* if and only if  $\Gamma \models B$  for every  $B \in \mathcal{S}$ . (Based on the proof method for 2.10.3.)

**Corollary 3.5.5.1** A nonempty finite set of premises  $\Gamma \subset \mathcal{S}$  is *consistent* if and only if there exists some  $B \in \mathcal{S}$  such that  $\Gamma \not\models B$ .

**Corollary 3.5.6.1** A nonempty finite set of premises  $\Gamma \subset \mathcal{S}$  is *consistent* if and only if it is *satisfiable*.

Even though we seem to have strong results that can be used to determine whether a sentence is a valid consequence or that such a set is consistent, it turns out that it's often very difficult to make such judgments for the language *Pd*. The reasons for this vary in complexity. One basic reason is that some sets

of premises tend to imply that the domain  $D$  is not finite. Further, when we made such determinations for  $L$ , we have a specifically definable process that can be followed, the truth-table method. It can actually be shown, that there is no known method to describe one fixed process that will enable us to determine whether a sentence is valid or whether a set of premises is consistent. Thus we must rely upon ingenuity to establish by models these concepts. Even then some mathematicians do not accept such metaproofs as informally correct since some claim that the model chosen is defined in an unacceptable manner. The next examples show how we must rely upon the previous definitions and metatheorems to achieve our goals of establishing valid consequences or consistency. In some cases, however, no amount of informal argument will establish the case one way or the other with complete assurance. I point out that these formal sentences are translations from what ordinary English language sentences.

---

If you are given a finite set of premises  $A_1, \dots, A_n$  then there are various ways to show that  $A_1, \dots, A_n \models B$ . One method is to use that Deduction Theorem and a general argument that  $\models A_1 \wedge \dots \wedge A_n \rightarrow B$ ; the propositional method of assuming that for a structure  $\mathcal{M}_I$  in general if  $\not\models B$ , then  $\not\models A_1$  or  $\not\models A_2$ . For the invalid consequence concept, you have two choices, usually. Consider ANY structure  $\mathcal{M}_I$  such that  $\mathcal{M}_I \not\models B$  and show that this leads to each  $\mathcal{M}_I \models A_i$ ,  $i = 1, \dots, n$ . However, to show that  $A_1, \dots, A_n \not\models B$ , it is often easier to define a structure  $\mathcal{M}_I$  and show that  $\mathcal{M}_I \models A_i$ ,  $i = 1, \dots, n$ , but that  $\mathcal{M}_I \not\models B$  (i.e. the definition for valid consequence does not hold.) Note that if there is no  $\mathcal{M}_I$  such that  $\mathcal{M}_I \not\models B$ , then  $\models B$ .

---

**Example 3.5.1.** Consider the premises  $A_1 = \forall x(P(x) \rightarrow (\neg Q(x)))$ ,  $A_2 = \forall x(W(x) \rightarrow P(x))$ ,  $B = \forall x(W(x) \rightarrow (\neg Q(x)))$ . We now (attempt) to determine whether  $\models A_1 \wedge A_2 \rightarrow B$ .

Let  $\mathcal{M}_I$  be any structure. First, let  $D$  be any nonempty domain and the  $P'$ ,  $Q'$ ,  $W'$  be any subsets of  $D$  (not including the possible empty ones). Suppose that  $\mathcal{M}_I \not\models \forall x(W(x) \rightarrow (\neg Q(x)))$ . Then there exists some  $c' \in D$  such that  $\mathcal{M}_I \not\models S_c^x(W(x) \rightarrow (\neg Q(x))) = W(c) \rightarrow (\neg Q(c))$ . From our definition of what  $\mathcal{M}_I \not\models$  means, (\*)  $\mathcal{M}_I \models W(c)$  (\*) and that  $\mathcal{M}_I \not\models \neg Q(c)$ ; which means that  $\mathcal{M}_I \models Q(c)$ . This does not force any of the premises to have a specific  $\models$  or  $\not\models$ . Thus as done for the propositional calculus, let  $\mathcal{M}_I \models A_2 = \forall x(W(x) \rightarrow (\neg Q(x)))$ . Hence, for all  $d' \in D$ , we have that  $\mathcal{M}_I \models W(d) \rightarrow P(d)$ . Now  $c$  is one of the  $d$ s. Hence, we have that  $\mathcal{M}_I \models W(c) \rightarrow P(c)$ . What does this do to  $A_1$ ? We show that  $\mathcal{M}_I \not\models A_1$ . Assume that  $\mathcal{M}_I \models A_1$ . Hence, for all  $d' \in D$ ,  $\mathcal{M}_I \models P(d) \rightarrow (\neg Q(d))$ . Again this would give  $\mathcal{M}_I \models P(c) \rightarrow (\neg Q(c))$ . We know that  $\mathcal{M}_I \not\models \neg Q(c)$ . Hence  $\mathcal{M}_I \not\models P(c)$ . Thus  $\mathcal{M}_I \not\models W(c)$ . This contradicts the (\*) expression. Hence,  $\mathcal{M}_I \not\models A_1$ . Now consider an empty  $W'$ . Then  $\mathcal{M}_I \models \forall x(W(x) \rightarrow (\neg Q(x)))$ . Consider  $Q'$  empty and  $W'$  not empty. Then  $\mathcal{M}_I \models \forall x(W(x) \rightarrow (\neg Q(x)))$ . Hence,  $B$  is a valid consequence of  $A_1, A_2$ .

**Example 3.5.2.** Let  $A_1 = \exists x(P(x) \rightarrow Q(x))$ ,  $A_2 = \forall x(W(x) \rightarrow P(x))$ ,  $B = \exists x(W(x) \rightarrow (\neg Q(x)))$ . Is  $B$  a valid consequence of the premises? Well, we guess, that this might be an invalid consequence. We try to find a structure  $\mathcal{M}_I$  such that  $\mathcal{M}_I \models A_1$ ,  $\mathcal{M}_I \models A_2$  and  $\mathcal{M}_I \not\models B$ . Let  $D = \{a'\}$ ,  $P' = Q' = W' = D$ . There are no constants in the sentences  $A_1$ ,  $A_2$  or  $B$ .  $N$  contains only one constant  $a$  which is interpreted as  $a'$ . Clearly,  $\mathcal{M}_I \models A_1$  and  $\mathcal{M}_I \models A_2$ . But,  $\mathcal{M}_I \models W(a)$  and  $\mathcal{M}_I \not\models (\neg Q(a))$ . Consequently,  $\mathcal{M}_I \not\models B$ . [Note the difficulty would be to first have a “feeling” that the argument from which these formula are taken is not logically correct and then construct an acceptable structure that establishes this “feeling.” Not an easy thing to do, if it can be done at all.]

**Example 3.5.3.** Let  $A = \exists y(\forall xP(x, y))$  and  $B = \forall x(\exists yP(x, y))$ . [In this case,  $P'$  cannot be the empty relation, for if this were the case, then  $\mathcal{M}_I \not\models A$  for an appropriate structure.] We try to show that  $A \models B$  and get nowhere. So, maybe the  $A \not\models B$ . Let's see if we can obtain a countermodel. Let  $D = \{a', b'\}$ . Let  $P' = \{(a', b'), (b', a')\}$ . Now extend this construction to a structure  $\mathcal{M}_I$  for  $Pd$ . Then for each  $d' \in D$  there exists some  $c' \in D$  such that  $(c', d') \in P'$ , which implies that  $\mathcal{M}_I \models A$ . On the other hand, there does not exist some  $d' \in D$  such that for each  $c' \in D$ ,  $(c', d') \in P'$ . Hence,  $\mathcal{M}_I \not\models B$  for this structure. Thus,  $B$  is not a valid consequence of  $A$ . However, it can easily be shown that  $A$  is a valid consequence of  $B$ .

**Example 3.5.4.** Determine whether  $A_1 = \forall x(P(x) \rightarrow (\neg Q(x)))$ ,  $A_2 = \forall x(W(x) \rightarrow P(x))$  is a consistent set of premises. This is not very difficult since we notice that if we construct a structure such that for each  $d' \in D$   $\mathcal{M}_I \not\models P(d)$  and  $\mathcal{M}_I \not\models W(d)$ , then this structure would yield that the set is consistent. Simply let  $P'$  and  $W'$  be the empty set (and extended the construction to all of  $Pd$ ) and the conditions are met. Thus the set of premises is consistent.

**Example 3.5.5.** Add the premise  $A_3 = \forall x(\neg P(x))$  to the premises  $A_1$  and  $A_2$  in example 3.5.3. The same structure yields  $\mathcal{M}_I \models A_3$ . Thus this new set of premises is consistent.

**Example 3.5.6.** Determine whether  $A_1 = \forall x(P(x) \wedge (\neg Q(x)))$ ,  $A_2 = \forall x(W(x) \wedge P(x))$  form a consistent set of premises. Clearly, using only empty sets for the relations will not do the job. Let  $D = \{d'\}$ . Now let  $P' = W' = D$  and  $Q'$  is the empty set. Then for all  $d' \in D$ ,  $\mathcal{M}_I \models P(d)$ ,  $\mathcal{M}_I \models W(d)$ ,  $\mathcal{M}_I \models (\neg Q(d))$ .

To show inconsistency, constructing models will not establish anything since we must show things don't work for *any* structure. The argument must be a general argument.

**Example 3.5.7.** Let  $A_1 = \exists x(\neg P(x))$ ,  $A_2 = \forall x(Q(x) \rightarrow P(x))$  and  $A_3 = \forall xQ(x)$ . Let  $\mathcal{M}_I$  be any structure such that  $\mathcal{M}_I \models \forall xQ(x)$ . Then whatever set  $Q' \subset D$  you select, it must have the property that for all  $d' \in D$ ,  $d' \in Q'$ . Hence,  $Q' = D$ . Now if  $\mathcal{M}_I \models A_2$ , then for all  $d' \in D$ ,  $\mathcal{M}_I \models Q(p) \rightarrow P(d)$ . Thus for all  $d' \in D$ ,  $\mathcal{M}_I \models P(d)$  implies that  $d' \in P'$ . Thus  $P' = D$ . It follows that there does not exist a member  $d'$  of the set  $P'$  such that  $d'$  is not a member of  $P'$ . Thus  $\mathcal{M}_I \not\models A_1$ . Hence, the set of premises is inconsistent.

It might appear that it's rather easy to show that sets of premises are or are not consistent, or that sentences are valid consequences of sets of premises. But, there are sets of premises such as the 14 premises discovered by Raphael Robinson for which it can be shown that there is no known way to construct a model for these premises without assuming that the model is constructed by means that are either equivalent to the premises themselves or by means that assume a set of premises from which Robinson's premises can be deduced. Such an obvious circular approach would not be accepted as an argument for the consistency of the Robinson premises. The difficulty in determining valid consequences or consistency occurs when nonempty  $n$ -place,  $n > 1$ , and nonfinite domains are needed to satisfy some of the premises. The only time you are sure that your model will be accepted by the mathematical community for consistency argument is when your model uses a finite domain. Robinson's system, if it has a model, must have a domain that is nonfinite. Further, the set of natural numbers satisfies the Robinson axioms.

Due to the above mentioned difficulties, it's often necessary to consider a weaker form of the consistency notion – a concept we term *relative consistency*. If you have empirical evidence that a set of premises  $\Gamma$  is consistent, then they can be used to obtain additional premises that we know are also consistent. After we show the equivalence of formal proof theory to model theory, then these premises can be used to construct models.

**Theorem 3.5.7** *If a nonempty set of premises  $\Gamma$  is consistent and  $\Gamma \models B_i$ , where each  $B_i$  is sentence, then the combined set of premises  $\Gamma \cup \{B_i\}$  is consistent.*

Proof. From consistency, there is a structure  $\mathcal{M}_I$  such that for each  $A \in \Gamma$ ,  $\mathcal{M}_I \models A$ . But for  $\mathcal{M}_I$  we also have that  $\mathcal{M}_I \models B_i$  for each  $i$ . Consequently, the structure  $\mathcal{M}_I$  yields the requirements for the set of premises  $\Gamma \cup \{B_i\}$  to be consistent.

### EXERCISES 3.5

1. The following are translations from what we are told are valid English language argument. Use the model theory approach and determine if, indeed, the sentence  $B$  is a valid consequence of the premises.

(a)  $A_1 = \forall x(Q(x) \rightarrow R(x))$ ,  $A_2 = \exists xQ(x) \models B = \exists xR(x)$ .

- (b)  $A_1 = \forall x(Q(x) \rightarrow R(x)), A_2 = \exists x(Q(x) \wedge Z(x)) \models B = \exists x(R(x) \wedge Z(x)).$   
(c)  $A_1 = \forall x(P(x) \rightarrow (\neg Q(x))), A_2 = \exists x(Q(x) \wedge R(x)) \models B = \exists x(R(x) \wedge (\neg Q(x))).$   
(d)  $A_1 = \forall x(P(x) \rightarrow Q(x)), A_2 = \exists x(Q(x) \wedge R(x)) \models B = \exists x(R(x) \wedge (\neg Q(x))).$

### 3.6 Formal Proof Theory

I hope to make the formal proof theory for this language as simple as possible. Again we will only do formal proofs or demonstrations that will lead directly to our major conclusions. **The language will be  $Pd' \subset Pd$ , where no existential quantifiers appear.** Later we will simply use the abbreviation  $\exists xA$  for the expression  $\neg(\forall x(\neg A))$ . This will allow us to extend all the proof theoretic notions for  $Pd'$  to  $Pd$ . Also recall that the language  $Pd$  can actually be considered as constructed with the connectives  $\wedge, \vee, \leftrightarrow$  since these were abbreviations for the equivalent propositional equivalent formula. (i)  $A \vee B$  is an abbreviation for  $(\neg A) \rightarrow B$ . (ii)  $A \wedge B$  is an abbreviation for  $(\neg(A \rightarrow (\neg B)))$ . (iii)  $A \leftrightarrow B$  is an abbreviation for  $(A \rightarrow B) \wedge (B \rightarrow A)$ . From the semantics, these formula have the same pattern for  $\models$  as they have for truth-values if it is assumed that  $A, B \in L$  (say  $A, B \in \mathcal{S}$ )

**Definition 3.6.1** The language  $Pd'$  is that portion of  $Pd$  in which no formula contains an existential quantifier.

**Definition 3.6.2** (A formal proof of a theorem)

(1) Use the entire process as described in definition 2.11.2 for the language  $L'$  with the following additions to the axioms  $P_1, P_2, P_3$  and to the rule modus ponens.

(2) For predicate variables  $A, B$  (i.e. metasympols for any formula) you may write down as any step the formula

$$P_4 : \forall x(A \rightarrow B) \rightarrow (A \rightarrow (\forall xB)) \text{ whenever } x \in \mathcal{V} \text{ AND } x \text{ is NOT free in } A.$$

$$P_5 : (\forall xA) \rightarrow S_{\lambda}^x A \text{ whenever } \lambda \in \mathcal{V} \text{ AND } \lambda \text{ is free for } x \text{ OR } \lambda \in \mathcal{C} \text{ (the set of constants, if any.)}$$

(3) You add one more rule of inference, the rule called *generalization*.  $G(i)$ . Taking any previous step  $B_i$ , you may write down as a new step with a larger step number the step  $\forall xB_i$ , for any  $x \in \mathcal{V}$ .

(4) If you follow the above directions and the last step in your formal proof is  $A$  then we call  $A$  a *theorem* for  $Pd'$  and denote this (when no confusing will result) by  $\vdash A$ .

The additional steps that can be inserted when we construct a formal demonstration from a set of premises is exactly the same as in definition 2.12.1.

**Definition 3.6.3** Let  $\Gamma$  be any subset of  $Pd'$ . Then a *formal demonstration* from  $\Gamma$  follows the exact same rules as in definition 3.6.2 with the additional rule that we are allowed to insert as a step at any point in the demonstration a member of  $\Gamma$ . If the last formula in the demonstration is  $A$ , then  $A$  is a deduction from  $\Gamma$  and we denote this, when there is no confusion, by the symbol  $\Gamma \vdash A$ .

Of course, a formal proof of a theorem or a demonstration for a formula contains only a finite number of steps. Do we already have a large list of formal proofs for formal theorems that can be used within the proof theory for  $Pd'$ ?

**Theorem 3.6.1** Consider any formal proof in  $L'$  for the  $L'$  theorem  $A$ . For each specific propositional variable within  $A$ , substitute a fixed predicate variable at each occurrence of the propositional variable in  $A$  to obtain the predict formula  $\hat{A}$ . Then for  $Pd'$ , we have that  $\vdash \hat{A}$ .

Proof. Simply take each step in the formal proof in  $L'$  that  $\vdash A$  and make the same corresponding consistent variable predicate substitutions. Since each axiom  $P_1, P_2, P_3$  and the MP rule are the same in  $Pd'$ , this will give a formal proof in  $Pd'$  for  $\vdash \hat{A}$ . ■

**Theorem 3.6.2** Let  $\Gamma \subset Pd'$  and  $A, B \in Pd'$ .

- (a) If  $A \in \Gamma$  or  $A$  is an instance of an axiom  $P_i$ ,  $1 \leq i \leq 5$ , then  $\Gamma \vdash A$ .
- (b) If  $\Gamma \vdash A$  and  $\vdash A \rightarrow B$ , then  $\Gamma \vdash B$ .
- (c) If  $\vdash A$ , then  $\Gamma \vdash A$ .
- (d) If  $\Gamma$  is empty and  $\Gamma \vdash A$ , then  $\vdash A$ .
- (e) If  $\Gamma \vdash A$  and  $D$  is any set of formula, then  $\Gamma \cup D \vdash A$ .
- (f) If  $\Gamma \vdash A$ , then there exists a finite  $D \subset \Gamma$  such that  $D \vdash A$ .

Proof. The same proof for theorem 2.12.1.

We now give an example of a formula that is a member of  $Pd'$  and is not obtained by the method that yields  $\hat{A}$  and is a formal theorem.

**Example 3.6.1** For any 1-place predicate  $P(x) \in Pd'_0$ ,  $x, y \in \mathcal{V}$ ,  $\vdash (\forall xP(x)) \rightarrow (\forall yP(y))$ .

- (1)  $(\forall xP(x)) \rightarrow P(y)$   $P_5$
- (2)  $\forall y((\forall xP(x)) \rightarrow P(y))$   $G(1)$
- (3)  $\forall y((\forall xP(x)) \rightarrow P(y)) \rightarrow ((\forall xP(x)) \rightarrow (\forall yP(y)))$   $P_4$
- (4)  $(\forall xP(x)) \rightarrow (\forall yP(y))$   $M(1,3)$

It should be noted, that if  $x$  is not free in  $A$ , then  $P_5$  yields  $(\forall xA) \rightarrow S_y^x A] = (\forall xA) \rightarrow A$ , for any  $\lambda \in \mathcal{V} \cup \mathcal{C}$ , since the second  $A$  has had no changes made. Further, if  $x$  is free in  $A$ , then  $P_5$  yields  $(\forall xA) \rightarrow A$ .

**Example 3.6.2** (Demonstration)

$$A \rightarrow (\forall xB) \vdash \forall x(A \rightarrow B)$$

- (1)  $A \rightarrow (\forall xB)$  Premise
- (2)  $(\forall xB) \rightarrow S_x^x B] = (\forall xB) \rightarrow B$   $P_5$
- (3)  $A \rightarrow B$  HS(1,2)
- (4)  $\forall x(A \rightarrow B)$   $G(3)$

The rule that we have given for Generalization is not the only rule of this type that is used throughout the literature. In particular, some authors define deduction from a set of premises in a slightly different manner than we have defined it. The reason for this depends upon how nearly we want the deduction theorem for  $Pd'$  to mimic the deduction theorem for  $L'$ , among other things. Also, note that the statement that  $y$  is free for  $x$ , holds when  $x$  does not occur in  $A$  or does not occur free in  $A$ . The following two results are useful in the sequel.

**Theorem 3.6.3** If  $y$  is free for  $x$  in  $A \in Pd'$ , then  $\forall xA \vdash \forall yS_y^x A]$ .

- (1)  $\forall xA$  Premise
- (2)  $(\forall xA) \rightarrow S_y^x A]$   $P_5$
- (3)  $S_y^x A]$  MP(1,2)
- (4)  $\forall yS_y^x A]$   $G(3)$

**Corollary 3.6.3.1** If  $y$  does not appear in  $A$ , then  $\forall yS_y^x A] \vdash \forall xA$ .

Proof. This follows since, in this case,  $y$  is free for  $x$  for  $y$  cannot be bound by any quantifier and  $x$  is free for  $y$  for  $S_y^x A$ . Further,  $A = S_x^y S_y^x A]$ . We now apply theorem 3.6.3. Hence,  $\forall yS_y^x A \vdash \forall x[S_y^x S_y^x A]] = \forall xA$ .

**Theorem 3.6.4** Let  $\{x_1, x_2, \dots, x_n\}$  be any  $n$  free variables in  $A \in Pd'$ . Then  $\Gamma \vdash A$  if and only if  $\Gamma \vdash \forall x_1(\forall x_2(\dots(\forall x_n A)\dots))$ .

Proof. Let  $n = 0$ . The result is clear.

Let  $n = 1$ . If  $\Gamma \vdash A$  has  $x_1$  as free, then by application of generalization on  $x_1$  we have that  $\Gamma \vdash \forall x_1 A$ .

Suppose that result holds for  $n$  free variables and suppose that  $x_1, \dots, x_{n+1}$  are free variables in  $A$ . Then  $x_1, \dots, x_n$  are free variables in  $\forall x_{n+1} A$ . Now if  $\Gamma \vdash A$ , then  $\Gamma \forall x_{n+1} A$  by generalization. Hence, from the induction hypothesis,  $\Gamma \vdash \forall x_1(\forall x_2(\dots(\forall x_{n+1} A)\dots))$ . Hence, by induction, for any  $n$  free variables in  $A$  the result holds.

The converse follows by a like induction proof through application of  $P_5$  and one MP. ■

**Corollary 3.6.3.1** For any  $A \in Pd'$ ,  $\Gamma \vdash A$  if and only if  $\Gamma \vdash \forall A$ .

**Theorem 3.6.5** For any  $A \in Pd'$ , if  $x \in \mathcal{V}$ , then  $\Gamma \vdash A$  if and only if  $\Gamma \vdash \forall x A$ .

Proof. Let  $\Gamma \vdash A$ . Then one application of generalization yields  $\Gamma \vdash \forall x A$ .

Conversely, suppose that  $\Gamma \vdash \forall x A$ . Then one application of  $\forall x A \rightarrow S_x^x A = \forall x A \rightarrow A$  followed by one MP yields  $A$ .

### EXERCISES 3.6

1. Complete the following formal demonstrations. Note that whenever  $P_5$  is applied, we write  $A$  for  $S_x^x A$ .

(A)  $\forall x(A \rightarrow B), \forall x(\neg B) \vdash \forall x(\neg A)$ .

- |   |                 |
|---|-----------------|
| (1) $\forall x(A \rightarrow B)$                                    | .....           |
| (2) $\forall x(\neg B)$   | .....           |
| (3) .....   | $P_5$           |
| (4) $A \rightarrow B$   | MP( , )         |
| (5) $(A \rightarrow B) \rightarrow ((\neg B) \rightarrow (\neg A))$ | Exer. 2.13, 2A. |
| (6) .....   | MP( , )         |
| (7) $(\forall x(\neg B)) \rightarrow (\neg B)$                      | .....           |
| (8) $\neg B$  | .....           |
| (9) $\neg A$  | .....           |
| (10) .....  | .....           |

(B)  $\forall x(\forall y A) \vdash \forall y(\forall x A)$

- |  |         |
|--|---------|
| (1) .....  | .....   |
| (2) $(\forall x(\forall y A)) \rightarrow \forall y A$ | $P_5$   |
| (3) .....  | MP( , ) |
| (4) .....  | $P_5$   |
| (5) $A$  | MP(3,4) |
| (6) $\forall x A$                                      | .....   |
| (7) $\forall y(\forall x A)$                           | .....   |

(C)  $A, (\forall x A) \rightarrow C \vdash \forall x C$

- |                   |       |
|-------------------|-------|
| (1) .....         | ..... |
| (2) $\forall x A$ | ..... |



(3) .....	.....
(4) $C$	MP(2,3)
(5) $\forall xC$	.....
(D) $\forall x(A \rightarrow B), \forall xA \vdash \forall xB$	
(1) .....	Premise
(2) .....	Premise
(3) .....	$P_5$
(4) $A \rightarrow B$	MP( , )
(5) $(\forall xA) \rightarrow A$	.....
(6) $A$	MP(2,5)
(7) $B$	.....
(8) $\forall xB$	.....

### 3.7 Soundness and Deduction Theorem for $Pd'$ .

Although the model theory portions of this text have been restricted to sentences, this restriction is technically not necessary. Many authors give valuation processes for any member of  $Pd'$ . This yields certain complications that appear only to be of interest to the logician. In the sciences, a theory is determined by sentences. These are language elements that carry a definite “will occur” or “won’t occur” content. As far as relations between proof theory concepts and the model theory concepts, we consider  $\Gamma \vdash A$ , where the elements need not be sentences. But for our model theory, we, at the least, require that each member of  $\Gamma$  is a sentence and can always let  $A$  be a sentence when  $\Gamma \models A$  is considered. When the notation  $\mathcal{M}_I$  is employed, it will be assume that  $\mathcal{M}_I$  is a structure for  $Pd'$ . Further, unless it is necessary, we will not mention that our language variable are member of  $Pd'$ . Next is an important relation between a model and a formal demonstration.

**Theorem 3.7.1 (Soundness Theorem)** *Suppose that  $\Gamma \subset \mathcal{S}$ ,  $\mathcal{M}_I \models \Gamma$ , and  $\Gamma \vdash A$ . Then  $\mathcal{M}_I \models A$  (i.e.  $\mathcal{M}_I \models \forall A$ .)*

Proof. In this proof, we use induction on the steps  $\{B_i \mid i = 1, \dots, n\}$  in a demonstration that  $\Gamma \vdash A$ , and show that  $\mathcal{M}_I \models \forall B_i$ .

Case ( $n = 1, 2, 3$ ). Let  $n = 1$ . Suppose that  $B_1$  is an instance of axioms  $P_1, P_2, P_3$ . First, recall the special process (i) of theorem 3.4.8. Thus, to establish that  $\mathcal{M}_I \models P_i$ , we may consider the language variables as being sentences. Now simply replicate the proof for theorem 3.4.2.

Suppose that  $C = \forall xB \rightarrow S_\lambda^x B$  is an instance of axiom  $P_5$ . Again we need only assume that  $x$  is the only free variable in  $B$ . Suppose that  $\lambda = y$  is free for  $x$  in  $B$ . Then theorem 3.4.7 (iii) yields the result. Let the substitution in  $P_5$  be a constant  $\lambda = c$ . Suppose that  $\mathcal{M}_I \models \forall xB$ . Then for all  $d' \in D$ ,  $\mathcal{M}_I \models S_{d'}^x B$ . In particular,  $\mathcal{M}_I \models S_c^x B$ . We leave it as an exercise, to show that if  $C$  is an instance of axiom  $P_4$ , then  $\mathcal{M}_I \models C$ . Finally, suppose that  $C \in \Gamma$ . Then  $\mathcal{M}_I \models \Gamma$  means that  $\mathcal{M}_I \models C$ .

Suppose  $n = 2$  and  $B_2 = \forall xB$ . Then for the case  $n = 1$ ,  $B_1 = B$  and  $\mathcal{M}_I \models B$  means that  $\mathcal{M}_I \models \forall B$ . Hence,  $\mathcal{M}_I \models \forall(\forall xB)$ .

Suppose that  $n = 3$  and  $B_3 = C$  is an MP step. Then for the two previous steps, we have that  $\mathcal{M}_I \models B$  and  $\mathcal{M}_I \models B \rightarrow C$ . From definition 3.3.3 and the special process,  $\mathcal{M}_I \models C$ .

Case ( $n + 1 > 3$ ). Assume the induction hypothesis that the result holds for any proof with  $n$  or less steps. Consider a proof with  $n + 1$  steps. Now let  $C = B_{n+1}$ . If  $C$  is an instance of any of the axioms, then

the result follows as in the case where  $n = 1$ . Suppose that  $C$  comes from two previous steps,  $B_i = B$  and  $B_j = B \rightarrow C$  by MP. By induction and the case  $n = 3$  process, we have that  $\mathcal{M}_I \models C$ . Now suppose that  $C = \forall xB$  is an instance of generalization. By induction and the case  $n = 2$  process, we have that  $\mathcal{M}_I \models C$ . Finally, for the case that  $C \in \Gamma$ , the result follows as in case  $n = 1$ . The complete result follows by induction.

■

**Corollary 3.7.1.1** *If  $\vdash A$ , then  $\models A$ .*

Of course, the importance of theorem 3.7.1 lies in desire that whatever is logically produced by the mind using scientific logic will also hold “true” for any model for which each of the hypotheses hold “true.” **This is the very basis for the scientific method assumption that human deductive processes correspond to natural system behavior.** Before we can establish a converse to theorem 3.7.1 and with it the very important “compactness” theorem, a deduction-type theorem is required. This theorem, however, will not completely mimic the deduction theorem for the language  $L'$ .

**Theorem 3.7.2** (*Deduction theorem for  $Pd'$ .*) *Let  $\Gamma \subset Pd'$ ,  $A, B \in Pd'$ . If  $\Gamma, A \vdash B$  and the demonstration for  $B$  contains no application of Generalization for a variable free in  $A$ , then  $\Gamma \vdash A \rightarrow B$ .*

Proof. We use all the methods described in the metaproof of theorem 2.13.1, the deduction theorem for  $L'$ . Proceed by induction exactly as done in theorem 2.13.1 and replace the axioms  $P_1, P_2, P_3, P_4, R_5$  with steps that lead to  $A \rightarrow C$ , no new step contains the single formula  $A$ . Now if  $A$  appears as a step then this formula as been replaced by a  $A \rightarrow A$ . This leaves the MP and Generalization steps to replace. Now re-number (i.e. count) these steps with their original ordering as  $G_1, \dots, G_n$ . We now consider the induction process on these steps.

Case  $n = 1$ . Suppose that  $G_1$  is an MP step. Then alter this step to produce other steps as done in the metaproof of theorem 2.13.1. Now suppose that  $G_1 = \forall yB$ , where  $B$  is from one of the previous original steps and was not obtained by generalization or MP. However, the original steps have all be replaced by  $A \rightarrow B$ . Between this new step and the step  $G_1$  insert the following three steps.

- |   |                |
|---|----------------|
| (1) $\forall y(A \rightarrow B)$  | Generalization |
| (2) $\forall y(A \rightarrow B) \rightarrow (A \rightarrow (\forall yB))$ | $P_4$          |
| (3) $A \rightarrow \forall yB$  | M(1,2)         |

[Notice that the insertion of step (2) requires that  $y$  not be free in  $A$ .] Now remove the original step  $G_1 = \forall yB$ .

Case (n+1) Assume that all the alterations have been made for  $G_1, \dots, G_n$  steps. If  $G_{n+1}$  is MP, proceed in the same manner as in theorem 2.13.1. Suppose that  $G_{n+1} = \forall yB$ , where  $B$  comes from an original step. However, by induction all of the previous steps  $B_i, i \leq n$  have been replaced by  $A \rightarrow B_i$ . Consequently, using this altered step, proceed as in case  $n = 1$  to obtain the formula  $A \rightarrow \forall yB$  that replaces step  $G_{n+1}$ . By induction, all the original steps have been changed to the form  $A \rightarrow B$  and  $A$  does not appear as a step in our new demonstration. The last step in our old demonstration was  $B$  and it now has been changed to  $A \rightarrow B$ . Hence the theorem has been proved. ■

**Corollary 3.7.2.1** *Let  $\{A_1, \dots, A_n\} \subset \mathcal{S}$  and  $A_1, \dots, A_n \vdash B$ . Then  $\vdash (A_1 \rightarrow (A_2 \rightarrow \dots (A_n \rightarrow B) \dots))$ .*

**Theorem 3.7.3** *Let  $\Gamma \subset Pd'$ ,  $A, B \in Pd'$ . If  $\Gamma, \vdash A \rightarrow B$ , then  $\Gamma, A \vdash B$ .*

Proof. The proof is the same as in theorem 2.13.1. ■

**Corollary 3.7.3.1** *If  $\vdash (A_1 \rightarrow (A_2 \rightarrow \dots (A_n \rightarrow B) \dots))$ , then  $A_1, \dots, A_n \vdash B$ .*

**Theorem 3.7.4** *Let  $\{A_1, \dots, A_n\} \subset \mathcal{S}$ . Then  $A_1, \dots, A_n \vdash B$  if and only if  $\vdash (A_1 \rightarrow (A_2 \rightarrow \dots (A_n \rightarrow B) \dots))$ .*

We now show why the deduction theorem must be stated with the additional restriction.

**Example 3.7.1** First, it is obvious that  $P(x) \vdash \forall xP(x)$ . Just do the two step demonstration with the premise as the first step, and generalization in  $x$  as the second step. Now to show that  $\not\vdash P(x) \rightarrow \forall xP(x)$ . Suppose that we assume that  $\vdash P(x) \rightarrow \forall xP(x)$ . Consider the follows formal proof.

(1) $\vdash P(x) \rightarrow \forall xP(x)$	Given
(2) $\vdash (B \rightarrow A) \rightarrow ((\neg A) \rightarrow (\neg B))$	(A) page 83.
(3) $\neg(\forall xP(x)) \rightarrow (\neg P(x))$	MP(1,2)
(4) $\forall x(\neg(\forall xP(x)) \rightarrow (\neg P(x)))$	G(3)
(5) $\forall x(\neg(\forall xP(x)) \rightarrow (\neg P(x))) \rightarrow (\neg(\forall xP(x)) \rightarrow (\forall x(\neg P(x))))$	$P_4$
(6) $\neg(\forall xP(x)) \rightarrow (\forall x(\neg P(x)))$	MP(4,5)

Now by the soundness theorem for  $Pd'$  (6) yields  $\models \neg(\forall xP(x)) \rightarrow (\forall x(\neg P(x)))$ . Consider the structure  $\mathcal{M}_I$  where  $D = \{a', b'\}$ , and  $P' = \{a'\}$ . Suppose that  $\mathcal{M}_I \models \neg(\forall xP(x))$ . This means that it is not the case that  $a' \in P'$ , or that  $b' \in P'$ . Since  $b' \notin P'$ , then  $\mathcal{M}_I \models \neg(\forall xP(x))$ . But  $\mathcal{M}_I \not\models \forall x(\neg P(x))$  for this means that for  $a'$  and  $b'$  we must have that  $a' \notin P'$  and  $b' \notin P'$  which is not the case. Hence,  $\not\models \neg(\forall xP(x)) \rightarrow (\forall x(\neg P(x)))$ . This contradiction shows that  $\not\vdash \neg(\forall xP(x)) \rightarrow (\forall x(\neg P(x)))$ . Thus the use of the unrestricted deduction theorem to go from  $P(x) \vdash P(x)$ , where we used generalization on  $x$ , to obtain  $P(x) \vdash \forall xP(x)$ , then to  $\vdash P(x) \rightarrow \forall xP(x)$  is in error.

### EXERCISES 3.7

1. Show that if  $A \in Pd'$ , and  $A$  is an instance of axiom  $P_4$ . Then  $\models A$ .

### 3.8 Consistency, Negation completeness and Compactness.

Almost all of the sciences, engineering and any discipline which must determine whether or not something “will occur” or “won’t occur,” use first-order languages to describe behavior. The material in this section covers the most important of all of the first-order language concepts. The ramifications of these investigations, some completed only 2 years ago, cannot be over stated. Many individuals who first obtained the results presented next, became, over night, world famous figures within the scientific community due to the significance of their findings. The conclusions in the next section on applications, can only be rigorously obtained because of the results we next present.

**Definition 3.8.1** A set of sentences  $\Gamma \subset \mathcal{S}$  is (*formally*) *consistent* if there does NOT exist a sentence  $B \in \mathcal{S}$  such that  $\Gamma \vdash B$  and  $\Gamma \vdash \neg B$ .

A set of sentences  $\Gamma \subset \mathcal{S}$  is *inconsistent* if it is not consistent.

A set of sentences  $\Gamma \subset \mathcal{S}$  is (*negation*) *complete* if for every  $B \in \mathcal{S}$  either  $\Gamma \vdash B$  or  $\Gamma \vdash \neg B$ .

**Theorem 3.8.1** A set of sentences  $\Gamma$  is inconsistent if and only if for every  $B \in Pd'$ ,  $\Gamma \vdash B$ .

Proof. First, suppose that  $\Gamma$  is inconsistent. Then there is some  $B \in \mathcal{S}$  such that  $\Gamma \vdash B$  and  $\Gamma \vdash \neg B$ . Hence there are two demonstrations that use finitely many members of  $\Gamma$  and yield the final steps  $B$  and  $\neg B$ . Put the two demonstrations together, and let  $B$  appear as step  $i$  and  $\neg B$  appear as step  $B_j$ . Now, as the next step, put the formal theorem (from the propositional calculus)  $\vdash \neg B \rightarrow (B \rightarrow A)$  from Exercise 2.11 problem 2b, where  $A$  is ANY member of  $Pd'$ . Now two MP steps yields the formula  $A$ .

Suppose that for any formula  $C \in Pd'$ , it follows that  $\Gamma \vdash C$ . Thus take any sentence  $B$ , where  $\neg B \in \mathcal{S}$  also. Then  $\Gamma \vdash B$  and  $\Gamma \vdash \neg B$ . ■

What theorem 3.8.1 shows is that if  $\Gamma$  is inconsistent, then there is an actual logical argument that leads to ANY pre-selected formula. The logical argument is correct. But the argument cannot differentiate between the concepts of “will occur” or “won’t occur.” Indeed, any scientific theory using such an argument would be worthless as a predictor of behavior. Well, is it possible that our definition for logical deduction without premises is the problem or must it be the premises themselves that lead to the serious theorem 3.8.1 consequences?

**Theorem 3.8.2** *There does not exist a formula  $B \in Pd'$  such that  $\vdash B$  and  $\vdash \neg B$ .*

Proof. Suppose that there exists a formula  $B$  such that  $\vdash B$  and  $\vdash \neg B$ . Using the same process as used in theorem 3.8.1, but only assuming that  $B \in Pd'$ , it follows that for any sentence  $A \in Pd'$ ,  $\vdash A$ . Hence  $\vdash \forall A$ . Thus by corollary 3.7.1.1, for any structure  $\mathcal{M}_I$  we have that  $\mathcal{M}_I \models \forall A$ . But the sentence in step (5) of example 3.7.1, does not have this property. The result follows from this contradiction. ■

Thus the difficulties discussed after theorem 3.8.1 are totally caused by the premises  $\Gamma$  and not caused by the basic logical processes we use. However, if it’s believed that a set of sentences is consistent, then we might be able to obtain a larger consistent set.

**Theorem 3.8.3** *Let  $\Gamma \subset \mathcal{S}$  be a consistent. Suppose that  $\Gamma \not\vdash B \in Pd'$ . Then  $\Gamma, (\neg\forall B)$  is consistent.*

Proof. Assume that there exists some sentence  $C$  such that (a)  $\Gamma, (\neg\forall B) \vdash C$  and (b)  $\Gamma, (\neg\forall B) \vdash \neg C$ . Now from the propositional calculus (c)  $\vdash (\neg C \rightarrow (C \rightarrow \forall B))$  and, hence, this holds for  $Pd'$ . Using both demonstrations (a) and (b), and inserting them as steps in a demonstration, adjoin the step  $(\neg C) \rightarrow (C \rightarrow \forall B)$ . Two MP steps, yield that  $\Gamma, \neg\forall B \vdash \forall B$ . Since  $\neg\forall B$  is a sentence, then the deduction theorem yields  $\Gamma \vdash (\neg\forall B) \rightarrow \forall B$ . Now adjoin the steps for the  $\vdash ((\neg\forall B) \rightarrow \forall B) \rightarrow \forall B$ . One more MP step yields the contradiction that  $\Gamma \vdash \forall B \vdash B$ . ■

**Corollary 3.8.3.1** *Suppose that  $\Gamma$  is any set of sentences and  $B$  is any sentence. If  $\Gamma, \neg B$  is inconsistent, then  $\Gamma \vdash B$ . If  $\Gamma, B$  is inconsistent, then  $\Gamma \vdash \neg B$ .*

Proof. If  $\Gamma$  is inconsistent, then the result follows. If  $\Gamma$  is consistent, then the result follows from the contrapositive of theorem 3.8.3. The second part follows from  $\neg(\neg B) \vdash B$  and  $B \vdash \neg(\neg B)$ .

**Theorem 3.8.4** *If consistent  $\Gamma \subset \mathcal{S}$ , then there is a language  $Pd''$  that contains all of the symbols of  $Pd'$ , but with an additional set of constants and only constants adjoined, and a set of sentences  $\Gamma'' \subset Pd''$  such that  $\Gamma \subset \Gamma''$  and  $\Gamma''$  is consistent and negation complete.*

Proof. See appendix.

We now come to the major concern of this section, an attempt to mimic, as close as possible, the completeness and consistency results for  $L'$ . In 1931, Gödel, in his doctoral dissertation, convincingly established his famous “completeness” theorem for  $Pd'$  by showing for the natural number domain that  $\vdash B$  if and only if  $\models B$ . Since that time Gödel’s methods have been highly refined and simplified. Indeed, totally different methods have achieved his results as simple corollaries and these new methods have allowed for a greater comprehension of the inner workings of structures and models.

**Theorem 3.8.5** *If consistent  $\Gamma \subset \mathcal{S}$ , then there exists a structure  $\mathcal{M}_I$  for  $Pd'$  such that  $\Gamma \vdash A$  if and only if  $\mathcal{M}_I \models \forall A$ . Further, the domain of  $\mathcal{M}_I$  is in one-to-one correspondence with the natural numbers.*

Proof. See appendix.

**Corollary 3.8.5.1** (Gödel) *Let  $A \in Pd'$ .  $\vdash A$  if and only if  $\models A$ .*

Proof. Let  $\Gamma = \emptyset$ . Assume that  $\vdash A$ . Corollary 3.7.1.1 to the soundness theorem yields  $\models A$ .

Conversely, assume that  $\not\vdash A$ . Then  $\not\vdash \forall A$ . Thus the set  $\{\neg(\forall A)\}$  is consistent by theorem 3.8.3. Hence, from 3.8.5, there exists a structure  $\mathcal{M}_I$  such that  $\mathcal{M}_I \models \{\neg(\forall A)\}$ . Consequently,  $\mathcal{M}_I \not\models \forall A$ . Thus  $\not\vdash A$ . ■

Due to corollary 3.8.5.1, the abbreviations we have used that yield quantifiers  $\exists x$ , and abbreviations for the connectives  $\vee, \wedge, \leftrightarrow$  all have the correct properties with respect to  $\models$  as they would under the truth-value definitions for  $L$ . This allows us to use the more expressive language  $Pd$  rather than  $Pd'$ .

**Theorem 3.8.6\*\*\*** *A nonempty set of sentences  $\Gamma \subset Pd$  is consistent if and only if  $\Gamma$  has a model.*

Proof. Let  $\Gamma$  be consistent. For each  $A \in \Gamma$ ,  $\Gamma \vdash A$ . Theorem 3.8.5 yields that there is a structure  $\mathcal{M}_I$  such that  $\mathcal{M}_I \models A$  for each  $A \in \Gamma$ . Hence  $\mathcal{M}_I$  is a model for  $\Gamma$ .

Conversely, assume that  $\mathcal{M}_I$  is a model for  $\Gamma$  and that  $\Gamma$  is inconsistent. Then let  $B$  be any sentence. Then  $\Gamma \vdash B$  and  $\Gamma \vdash \neg B$ . Hence the soundness theorem would imply that  $\mathcal{M}_I \models B$  and  $\mathcal{M}_I \models \neg B$ . This contradicts definition 3.3.3 part (e). ■

**Theorem 3.8.7** (Extended Completeness) *If  $\Gamma \subset Pd$  is a set of sentences,  $B$  is a sentence and  $\Gamma \models B$ , then  $\Gamma \vdash B$ .*

Proof. Let  $\Gamma \models B$  and  $\Gamma$  is not consistent. Then  $\Gamma \vdash B$ . So assume  $\Gamma$  is consistent and that  $\Gamma \not\vdash B$ . Then from theorem 3.8.3, the set of sentences  $\{\Gamma, \neg B\}$  is consistent. Thus  $\{\Gamma, \neg B\}$  has a model  $\mathcal{M}_I$ . Therefore,  $\mathcal{M}_I \not\models B$ . But  $\mathcal{M}_I \models \Gamma$ . Hence  $\mathcal{M}_I \models B$ . This contradiction yields the result. ■

We now come to one of the most important theorems in model theory. This theorem would have remained the only way to obtain useful models if other methods had not been recently devised. It's this theorem we'll use in the next section on applications.

**Theorem 3.8.8** (Compactness) *A nonempty set of sentences  $\Gamma \subset Pd$  has a model if and only if every finite subset of  $\Gamma$  has a model.*

Proof. Assume that  $\Gamma$  has a model  $\mathcal{M}_I$ . Then this is a model for any finite subset of  $\Gamma$ . [Note: it's a model for an empty set of sentences since it models every member of such a set. (There are none.)]

Conversely, suppose that  $\Gamma$  does not have a model. Then  $\Gamma$  is inconsistent. Hence, taken any sentence  $B \in Pd$ . Then there are two finite subsets  $F_1, F_2$  of  $\Gamma$  such that  $F_1 \vdash B$  and  $F_2 \vdash \neg B$ . Thus the finite subset  $F = F_1 \cup F_2$  is inconsistent. Hence  $F$  has no model. This completes the proof. ■

### Important Piece of History

It was convincingly demonstrated in 1931 by Gödel that there probably is no formal way to demonstrate that significant mathematical theories are consistent. For example, with respect to set-theory, the only known method would be to establish a contradiction that is not forced upon set-theory by an actual demonstrable error on the part of an individual. All mathematical and scientific theories can be stated in the first-order language of set-theory. There are approximately 50,000 research papers published each year in the mathematical sciences. No inconsistencies in modern set-theory itself has ever been demonstrated. The number theory we have used to establish all of the conclusions that appear in this book is thousands of years old and again no contradiction has ever been demonstrated. The theory of real numbers is hundreds of years old and no contradictions in the theory have ever been demonstrated. The specific axiomatic systems and logical procedures used to establish all of our results have never been shown to produce a contradiction. What all this tends to mean is that empirical evidence demonstrates that our basic mathematical theories and logical processes are consistent. Indeed, this evidence is more convincing than in any other scientific discipline. This is one reason why science tends to utilize mathematical models.

**Example 3.8.1** Let  $\mathcal{N}$  be the set of axioms for the natural numbers expressed in a set-theoretic language. Let  $Pd$  be the first-order language that corresponds to  $\mathcal{N}$ . Then the theory of natural numbers

is the set of sentences  $\Gamma = \{B \mid B \in \mathcal{S}, \mathcal{N} \vdash B\}$ . This set  $\Gamma$  is assumed, from evidence, to be consistent. Hence from theorem 3.8.6 there exists a structure  $\mathcal{M}_I$  such that  $\mathcal{M}_I \models \Gamma$ . This means from the definition of  $\mathcal{M}_I \models \Gamma$  that there is a set of constants that *name* each member of the domain of the structure. This domain is denoted by the symbol  $\mathbb{N}$ . There are also n-ary predicate symbols for the basic relations needed for the axiom system and for many defined relations.

We interpret  $P(x, y)$  as the “=” of the natural numbers in  $\mathbb{N}$ . Depending upon the structure, this could be the simple identity binary relation  $P(x, x)$ . Now we come to the interesting part. Let our language constants  $C$  be the constants naming all the members  $c'$  of  $\mathbb{N}$  and adjoin to  $C$  a new constant  $b$  not a member of  $C$ . Consider the sentences  $\Phi = \{\neg P(c, b) \mid c \in C\}$  that are members of a first-order language  $Pd_b$  that is exactly the same as  $Pd$  except for adjoining one additional constant  $b$ . Now consider the entire set of sentences  $\Gamma \cup \Phi$ . What we will do is to show that  $\Gamma \cup \Phi$  has a model,  $^*\mathcal{M}_I$ , by application of the compactness theorem.

Take any finite set  $A$  of members of  $\Gamma \cup \Phi$ . If each member of  $A$  is a member of  $\Gamma$ , then  $\mathcal{M}_I$  is a model for  $A$ . Indeed, if  $\{a_1, \dots, a_n\}$  are all the members of  $A$  that are members of  $\Gamma$ , then again  $\mathcal{M}_I \models \{a_1, \dots, a_n\}$ . So, assume that  $\{a_{n+1}, \dots, a_m\}$  are the remaining members of  $A$  that may not be recognized as members of  $\Gamma$ . Well, there are only finitely many different constant  $\{c_{n+1}, \dots, c_m\}$  that are contained in these remaining sentences in  $A$ . The theory of natural numbers states that given any nonempty finite set of natural numbers, there is always another natural number  $c'$  that is not equal to any member of this finite set. These constants correspond to a finite set of natural numbers  $\{c'_{n+1}, \dots, c'_m\}$  and interpret  $b$  to be one of the natural numbers  $c'$ . **This process of interpreting, for a domain of the original structure, the one additional constant as an appropriate domain member is a general procedure that is usually needed when the compactness theorem is to be used.** Thus each of the remaining sentences is modeled by  $\mathcal{M}_I$ . The compactness theorem states that there is a structure  $^*\mathcal{M}_I$  such that  $^*\mathcal{M}_I \models \Gamma \cup \Phi$ . Thus there is a domain  $D$  and various n-place relations that behave exactly like the natural numbers since  $\Gamma$  is the theory of the natural numbers and  $^*\mathcal{M}_I \models \Gamma$ . Indeed, the interpretation  $I$  restricted to the original set of constants yields an exact duplicate of the natural numbers and we denote this duplicate by same symbol  $\mathbb{N}$ . But there exists a member of the domain  $D$  of this structure, say  $b'$ , such that for each  $c' \in \mathbb{N}$ ,  $b' \neq c'$ . But for every original  $c'$  we have that  $c' = c'$ . Therefore, we have a structure that *behaves*, as described by  $Pd_b$ , like the natural numbers, but contains a new member that does not correspond to one of the original natural numbers. [End of example.]

I give but two exercise problems for this section, each relative to showing that there exists mathematical structures that behave like well-known mathematical structures but that each contains a significant new member with a significant new property.

---



---

### EXERCISES 3.8

1. Modify the argument given in example 3.8.1 as follows: let  $L(x, y)$  correspond to the natural number binary relation of “less than” (i.e.  $<$ ). Give an argument that shows that there is a structure  $^*\mathcal{M}_I$  that behaves like the natural numbers but in which there exists a member  $b'$  that is “greater than” any of the original natural numbers. [Note: this solves the “infinite” natural number problem by showing that there exists a mathematical object that behaves like a natural number but is “greater than” every original natural number.
2. Let  $\mathbb{R}$  denote the set of all real numbers. Let  $C$  be a set of constants naming each member of  $\mathbb{R}$ .<sup>‡</sup> Suppose that  $b$  is a constant not a member of  $C$ . Let  $\Gamma$  be the theory of real numbers. Let  $Q(0, y, x)$  be the 3-place

---

<sup>‡</sup> The assumption is that the theory of real numbers is a consistent theory and, hence, has a model. The proofs of Theorems 3.8.4 and 8.8.5 in the appendix, show that such a theory has a model with a

predicate that corresponds to the definable real number 3-place relation  $0' < c' < d'$ , where  $0', c', d' \in \mathbb{R}$ . Now in the real numbers there is a set of elements  $G'$  such that each member  $c'$  of  $G'$  has the property that  $0' < c'$ . Let  $G$  be the set of constants that correspond to the members of the set  $G'$ . Consider the set of sentences  $\Phi = \{Q(0, b, g) \mid g \in G\}$  in the language  $Pd_b$ . Give an argument that shows that there exists a structure  ${}^*\mathcal{M}_I$  such that  ${}^*\mathcal{M}_I \models \Gamma \cup \Phi$ . That is there exists a mathematical domain  $D$  that behaves like the real numbers, but  $D$  contains a member  $b'$  such that  $b'$  is “greater than zero” but  $b'$  is “less than” every one of the original positive real numbers. [Note: this is an example of an infinitesimal and solves the three hundred year old problem of Leibniz, the problem to show the mathematical existence of the infinitesimals. These are objects that behave like real numbers but are not real numbers since they are greater than zero but less than any positive real number.]

The method used in this section and the next to obtain these “nonstandard” objects has been greatly improved over the years. The method presented here relies upon the assumption that the theory of real numbers and the theory of propositional deduction are consistent theories and, hence, have models. Also other processes have been employed that, although correct, may need further justification. Since the middle and late 1960s, algebraic methods have been used to first obtain structures associated with first-order statements. One structure, the standard structure  $\mathcal{M}$ , would be based upon predicates that are present within statements about the real numbers or, as explained in the next section, the first-order theory of propositional deduction. Another structure that can be considered as containing  $\mathcal{M}$  and termed an “enlargement,”  ${}^*\mathcal{M}$ , is then constructed. These constructions do require the acceptance of an additional set-theoretical axiom. To obtain the various nonstandard objects discussed in this and the next section, all that is needed is to have enough real number or propositional deduction statements hold in the standard structure. This will immediately show that the nonstandard objects, the infinitesimals, ultrawords and ultralogics, mathematically exist within the  ${}^*\mathcal{M}$ .

Due to the significance of exercise problem 2 above, the following slightly more general result is established here.

The following convention is used. The symbols used to denote constants and predicates will also be used to denote the members of the domain and relations in a structure  $\mathcal{M}_I$ . Let  $\Gamma$  be the theory of real numbers  $\mathbb{R}$ . This theory includes all of the defined relations and all possible deduced sentences, etc. For this example, there is a 1-place predicate  $P(x)$  that is modeled by the set of all positive real numbers  $P = \{x \mid (0 < x) \wedge (x \in \mathbb{R})\}$ , where 0 corresponds to the zero in  $\mathbb{R}$ . The basic predicate to be used here is  $Q(0, x, y)$ , where  $Q$  will correspond to the relation  $Q = \{(0, x, y) \mid (0 < |x| < y) \wedge (x \in \mathbb{R}) \wedge (y \in P)\}$ .

The most basic assumption is that  $\Gamma$  is consistent and from Theorem 1 it has a model  $\mathcal{M}_I$ , where  $\mathbb{R}$  is the domain. The facts are that from a viewpoint external to this structure, it can be assumed that all we need to name every member of  $\mathbb{R}$  is a set of constants that can be put into one-to-one relation with the even natural numbers, our most basic assumed consistent theory. So, let there be such a set of constants  $\mathcal{C}$  and consider but one more constant  $b$ . Consider the following set of sentences

$$\mathcal{A} = \{Q(0, b, a) \mid a \in P \subset \mathcal{C}\}.$$

Note that this does not add any new predicates. What we do is to show that the set of sentence  $\Gamma \cup \mathcal{A}$  has a model.

**Theorem.** *There is a structure  ${}^*\mathcal{M}_I$  that models  $\Gamma \cup \mathcal{A}$ , where the domain  ${}^*\mathbb{R}$  contains new objects not in  $\mathbb{R}$  and the entire theory  $\Gamma$  holds for  ${}^*\mathbb{R}$ .*

---

“denumerable” domain (i.e. can be put into a one-to-one correspondence with the natural numbers) and, hence, for this structure the set of constants used in our language for the real numbers and in definition 3.1 can be extended so as to name all the members of  $\mathbb{R}$ .

Proof. We have that  $\Gamma$  has a model  $\mathcal{M}_I$ . Let finite  $\{A_1, \dots, A_n\} \subset \mathcal{A}$ . If  $\{A_1, \dots, A_i\} \subset \Gamma$ , then  $\mathcal{M}_I \models \{A_1, \dots, A_i\}$ . Suppose that  $\{A_{i+1}, \dots, A_n\} \subset \mathcal{A}$ , where  $A_k = Q(0, b, a_k)$ ,  $i + 1 \leq k \leq n$ . Then  $\{a_{j+1}, \dots, a_n\}$  contains a minimal member in  $\mathbb{R}$ ,  $a_k$ . Now let  $b$  correspond to  $a_k/2$ . Then for this member of  $\mathbb{R}$  we have that  $\mathcal{M}_I \models \{A_{i+1}, \dots, A_n\}$ . Thus, by the Compactness Theorem, there is a structure  ${}^*\mathcal{M}_I$  such that  ${}^*\mathcal{M}_I \models \mathcal{A}$ .

■

Now there are no new predicates in  $\mathcal{A}$ . The only thing that can be different is the domain  ${}^*\mathbb{R}$ . Of course, all relations that model these predicates are now relative to  ${}^*\mathbb{R}$ . What we are doing is metalogically investigate the two structures  $\mathcal{M}_I$  and  ${}^*\mathcal{M}_I$  from the external world rather than only internal to either of the structures. By convention, we denote some of the predicates as they are interpreted in  ${}^*\mathcal{M}_I$  for  ${}^*\mathbb{R}$  by the same letter when there is no confusion as to which domain they apply; otherwise, they will be preceded by a  $*$  (translated by the word “hyper”). As pointed out, each member of the original  $\mathbb{R}$  is named by a constant from  $\mathcal{C}$  and these same constants name members of  ${}^*\mathbb{R}$ . We call each such interpreted constant a **standard** member of  ${}^*\mathbb{R}$ . What happens is that there is a object in  ${}^*\mathbb{R}$  that now is being named by  $b$ , and that we denote by  $\epsilon$ . This  $\epsilon \neq a$  for any standard member of  ${}^*\mathbb{R}$ . Why? Well, take any standard  $r \in {}^*\mathbb{R}$ . Using the theory  $\Gamma$ , if  $\epsilon = r$ , then we have contradicted that if  $\epsilon < r$ , then  $\epsilon \neq r$ . Thus, this is a new object that does not correspond to any standard element of  ${}^*\mathbb{R}$ . Moreover, there are two such objects since  $\Gamma$  holds for  ${}^*\mathbb{R}$ , and, hence,  $-\epsilon \in {}^*\mathbb{R}$  and  $|-\epsilon| = |\epsilon|$ . [As indicated the “ $\leq$ ,” “ $|\cdot|$ ,” and “ $=$ ” predicates must be interpreted in  ${}^*\mathcal{M}_I$ . This is the last time I’ll mention this fact.]

The objects  $-\epsilon$ ,  $\epsilon$  are called **infinitesimals**. But do they behave like the *infinitely small or little* ideal numbers  $o$  of Newton? Newton, as well as Leibniz, required the  $o$ , on one hand, to behavior like a non-zero real number but then to behave like a zero. This is why some people rejected the entire idea of an “ideal” number like  $o$  since it contradicts real number behavior. For example, Newton divides the equation  $3pox^2 + 3p^2o^2x + p^3o^3 - 2dqoy - dq^2o^3 - abpo = 0$  by  $o$  where  $o$  cannot act like a zero, and gets  $3px^2 + 3p^2ox + p^3o^2 - 2dqy - dq^2o - abp = 0$ . But now, he treats  $o$  as if it is zero and writes “Also those terms are infinitely little where  $o$  is. Therefore, omitting them there results  $3px^2 - abp - 2dqy = 0$ .” This is a direct contradiction as to the behavior of the  $o$  and, indeed, one should be able to apply the “omitting” process to the first equation and this would only yield the identity  $0 = 0$ .

First, let  $\mu(0)$  be the set of all infinitesimals in  ${}^*\mathbb{R}$  and include standard 0 in this set. To determine that members of  $\mu(0)$  have properties different from those of the original  $\mathbb{R}$ , we must investigate these from the “meta” viewpoint. The non-Greek lower case letters will always be the constants used to name the standard members of  ${}^*\mathbb{R}$ .

(1) Let  $0 \neq \lambda \in \mu(0)$ . Let non-zero standard  $r \in {}^*\mathbb{R}$  and arbitrary standard  $x \in {}^*P$ . Then  $0 < |\lambda| < x/|r|$  since  $x/|r|$  is as standards member of  ${}^*P$ . From the theory  $\Gamma$ , we have that  $0 < |r\lambda| < x$ . Thus  $r\lambda \in \mu(0)$  since  $x$  is an arbitrary standard member of  ${}^*P$ . [Note: Some would write this as  ${}^*r\lambda \in \mu(0)$ .]

(2) Using stuff from (1), let  $\lambda, \gamma \in \mu(0)$ . We have that  $0 < |\lambda| < x$  and  $0 < |\gamma| < y$  where both  $x$  and  $y$  are arbitrary standard members of  ${}^*P$ . Hence, from  $\Gamma$ , we have that  $0 < |\lambda + \gamma| \leq |\lambda| + |\gamma| < x + y$ . But  $x + y = z$  is also an arbitrary standard member  ${}^*P$ . Thus,  $\lambda + \gamma \in \mu(0)$ . In like manner  $\lambda\gamma \in \mu(0)$ .

(3) You can do all the ordinary real number algebra for the members of  $\mu(0)$  since  $\Gamma$  holds for them. However, if  $0 \neq \lambda$ , then  $1/\lambda \notin \mu(0)$ , since for arbitrary standard  $x \in {}^*P$ ,  $x < 1/\lambda$ .

(4) For  $r$ , let  $\mu(r) = \{r + \lambda \mid \lambda \in \mu(0)\}$ . This is can a *monad about  $r$* . Let  $r_1 \neq r_2$ . Then  $\mu(r_1)$  is completely disjoint from  $\mu(r_2)$ . Why? Well, suppose not. Then there are two infinitesimals  $\lambda, \gamma$  such that  $\lambda + r_1 = \gamma + r_2 \Rightarrow r_1 - r_2 = \gamma - \lambda \in \mu(0)$ . But  $r_1 - r_2$  is a standard number and the only standard number in  $\mu(0)$  is 0. Thus,  $r_1 = r_2$ ; a contradiction.

(5) Hence, every object in  ${}^*\mathbb{R}$  that behaves like the original real numbers is “surrounded,” so to speak, by its monad. Because of this uniqueness, we can for every member of  $\mu(r_1) \cup \mu(r_2) \cup \dots \cup \mu(r_n) \cup \dots = M_{fin}$ ,



where the  $r$  vary over all standard  ${}^*\mathbb{R}$ , define an operator  $\mathbf{st}$  with domain  $M_{fin}$  that yields the unique standard  $r$ . Although the notion of the “limit” need never be considered, the  $\mathbf{st}$  operator mirrors “limit” algebra and can be applied to the Newton material above.

Let Newton’s  $o = \lambda \neq 0$ . Consider  $3p\lambda x^2 + 3p^2\lambda^2 x + p^3\lambda^3 - 2dq\lambda y - dq^2\lambda^3 - abp\lambda = 0$ . Now divide by  $\lambda$  and get  $3px^2 + 3p^2\lambda x + p^3\lambda^2 - 2dqy - dq^2\lambda - abp = 0(1/\lambda) = 0$ . Using the properties of the  $\mathbf{st}$  operator applied to both sides of this equation,  $3px^2 + 3p^2\mathbf{st}(\lambda)x + p^3\mathbf{st}(\lambda^2) - 2dqy - dq^2\mathbf{st}(\lambda) - abp = 3px^2 + 3p^2(0)x + p^3(0) - 2dqy - dq^2(0) - abp = 3px^2 - 2dqy - abp = 0$ . Which is the same result as Newton’s and eliminates any contradiction.

### 3.9 Ultralogics and Natural Systems.

In 1949 in the Journal of Symbolic Logic, Leon Henkin gave a new proof for our theorem 3.8.5 from which the compactness theorem follows. Indeed, the proof that appears in the appendix is a modification of Henkin’s proof. I note that the appendix proof most also be modified if we wish to apply a compactness theorem to sets like the real numbers, as needed for exercise 3.8 problem 2. These modifications are rather simple in character and it’s assumed that whenever the compactness theorem is used that it has been established for the language being discussed.

What is particularly significant about the Henkin method is that it’s hardly possible to reject the method. Why? Well, as shown in the proof in the appendix the model is constructed by using the language constants and predicates themselves to construct the structure. What seems to be a very obvious approach was used 18 years after the first Gödel proof. There is a certain conceptual correspondence between the use of the language itself and the material discussed in this last section.

All of the metatheorems established throughout this text use a first-order metalanguage. These metatheorems describe various aspects of any formal first-order language. But these metatheorems also apply to informal languages that can be represented or encoded by a formal language. That is such concepts as the compactness theorem can be applied to obtained models for various “formalizable” natural languages and the logical processes used within science, engineering and many other disciplines. In 1963, Abraham Robinson did just this with the first published paper applying a similar device as the compactness theorem to obtain some new models for the valuation process within formal languages. Your author has extended Robinson’s work and has applied his model theoretic methods to all natural languages such as English, French, etc. The method used is the Tarski concept of the consequence operator. Before we apply the compactness theorem to obtain mathematically an ultralogic and an ultraword, a few very simply communication concepts need to be discussed.

**Definition 3.9.1** A *Natural system* is a set or arrangement of physical entities that are so related or connected as to form an identifiable whole. Science specifically defines such collections of entities and gives them identifying names. The universe in which we dwell, our solar system, the Earth, or a virus are Natural systems.

The appearance of most Natural systems changes with “time.” I’ll not define the concept of time, there are various definitions, and I simply mention that the time concept can be replaced by something else called a universal event number if the time concept becomes a philosophical problem. One of the most important aspects of any science that studies the behavior of a Natural system is the communication of the predicted or observed behavior to other individuals. This communication can come in the form of word-pictures or other techniques I’ll discuss below. Even if science cannot predict the past or future behavior of an evolving or developing (i.e. changing in time) Natural system, it’s always assumed that at any instant of time the appearance can be described.

---

**Definition 3.9.2** A *Natural event* is the actual and real objective appearance of a Natural system at a given instant whether or not it's described in any language or by other techniques.

---

From a scientific communication point of view, a description is all that can be scientifically known about such a Natural event and the description is substituted for it. Relative to the behavior of a Natural system, a general scientific approach is taken and it's assumed that scientists are interested in various types of descriptions for Natural system behavior. It's not difficult to show that all forms of scientific description can be reduced to finitely long strings of symbols. Modern computer technology is used to produce an exact string of symbols that will reproduce, with great clarity, any photograph, TV tape, or sound. Today, information is "digitized." Relative to a visual instant-by-instant description, television is used. Each small fluorescent region on a TV screen is given a coded location within a computer program. What electron beam turns on or off, the intensity of the beam and the like is encoded in a series of binary digits. The computer software then decodes this information and the beam sweeps out a glowing picture on a TV tube. At the next sweep, a different decoded series of digits yields a slightly different picture. And, after many hundreds of these sweeps, the human brain coupled with the eye's persistence of vision yields a faithful mental motion picture. Record companies digitize music in order to improve upon the reproduction quality. Schematics for the construction of equipment can be faithfully described in words and phrases if a fine enough map type grid is used. Thus, the complete computer software expressed in a computer language, the digitized inputs along with schematics of how to build the equipment to encode and decode digitized information, taken together, can be considered as an enormous symbol string the **exact** content of which will be what you perceive on "the tube," hear from a CD player, or other such devices.

Much of what science considers to be **perception** may be replaced by a long exact string of symbols. All of the methods used by science to communicate descriptions for Natural system behavior will be called the *descriptions*.

What all this means is that the actual objective evolution of a Natural system can be replaced by descriptions for how such a system appears at specific instances during its evolution. The actual time differences between successive "snap shorts" will depend upon the Natural system being studied, but they could be minuscule if need be. Just think of a developing Natural system as an enormous sequence of Natural events, that have been replaced by an enormous sequence of descriptions. As discussed above these descriptions can be replaced by finitely long strings of symbols of one sort of another. This communication fact is the common feature of all scientific disciplines.

The basic object used to study the behavior of Natural systems by means of descriptions of such behavior is the consequence operator described in section 2.16. Actually, consequence operators are used more for mathematical convenience than any other reason. For the purposes of this elementary exposition, ALL of the consequence operator results can be re-expressed in the  $\vdash$  notation. However, in the next definition we indicate how *deductive processes* such as the propositional process denoted by  $\vdash$  determine a consequence operator.

---

**Definition 3.9.3** For a propositional language  $\mathcal{L}$  and a propositional type of deduction from premises  $\Gamma \vdash_{\ell} B$ , a consequence operator  $C$  is defined as follows: For every  $\Gamma \subset L$ ,  $C(\Gamma) = \{A \mid A \in \mathcal{L} \text{ and } \Gamma \vdash_{\ell} A\}$ . Thus  $C(\Gamma)$  is the set of all formula "deduced" from  $\Gamma$  by the rules represented by  $\vdash_{\ell}$ .

---

Now recall the propositional language introduced in section 2.16. It's constructed from a set of atoms  $\{P_0, P_1, \dots\}$  in the usual manner, but only using the connectives  $\wedge$  and  $\rightarrow$ . Of course, this language  $L_S$  is a sublanguage of our basic language  $L$ . For formal deductive process, there are four axioms written in language variables.

$$(1) (A \wedge (B \wedge C)) \rightarrow ((A \wedge B) \wedge C).$$

- (2)  $(A \wedge B) \wedge C \rightarrow (A \wedge (B \wedge C))$ .
- (3)  $(A \wedge B) \rightarrow A$ .
- (4)  $(A \wedge B) \rightarrow B$ .

Notice that these axioms are theorems in  $L$  (i.e. valid formula) and, thus, also in  $L_S$ . The process of inserting finitely many premises in a demonstration is retained. The one rule of inference is *modus ponens* as before. We denote the deductive process these instructions yield by the usual symbol  $\vdash$ . The consequence operator defined by the process  $\vdash$  is denoted by  $S$ .

There is actually an infinite collection of deductive processes that can be defined for  $L$  and  $L_S$ . This is done by restricting the modus ponens rule.

---

**Definition 3.9.4** Consider all of the same rules as described above for  $\vdash$  except we use only the  $MP_n$  modus ponens rule. Suppose two previous steps of a demonstration are of the form  $A \rightarrow B$  and  $A$  and the  $\text{size}(A \rightarrow B) \leq n$ . Then you can write down at a larger step number the formula  $B$ . [This is not the only way to restrict such an MP process.] This is the only MP type process allowed for the  $\vdash_n$  deductive process.

---

The major reason the process  $\vdash_n$  is introduced is to simply indicate that there exist many different deductive processes that one can investigate. All of the metamathematical methods used to obtain the results in the previous sections of this text are considered as the most simplistic possible. They are the same ones used in the theory of natural numbers. Hence, they are considered as consistent. Thus, everything that has been done has a model. Let  $L = L'$  be the domain. The language contains a set of atoms  $\{P_0, P_1, \dots\}$ . Then we have the various 2-place relations between subsets of  $L'$  we have denoted by  $\vdash_n$  and  $\vdash$ . The first coordinate of each of these relations is a subset of  $L'$ , the premises, and the second coordinate is a single formula deduced from the premises. If the set of premises is the empty set, then the second coordinates are called theorems. To be consistent with our previous notation, we would denote the 2-place relations for a deductive processes by  $\vdash'_n$  and  $\vdash'$ . This would not be the case for the members of  $L'$ .

We now come to an important idea relative to the relation  $\vdash$  introduced, in 1978, by the author of this book. The metatheory we have constructed in the past sections of this text, the mathematical theory that tells us about the behavior of first-order languages and various deductive processes, is constructed from a first-order language using the vary deductive processes we have been studying. Indeed, all the proofs can be written in the exact same way as in the sections on formal deduction, using a different list of symbols or even the same list but, say, in a different color. Another method, the one that is actual used for the more refined and complex discusses of ultralogical and ultraword behavior, is to use another formal theory, first-order set theory, to re-express all of these previous metatheorems. In either case, the compactness theorem for first-order languages and deduction would hold.

There are two methods used to obtain models. If we assume that a mathematical theory is consistent, then the theory can be used to define a structure, which from the definition, would be a model for the theory. Theory consistency would yield all of the proper requirements for definition 3.3.3. On the other hand, you can assume that a structure is given. We assume that the n-place relations and constant named objects are related by a set of informal axioms that are consistent. Using this structure, we develop new information about the structure. This information is obtained by first-order deduction and is expressed in an informal first-order language. This informal first-order language can then be “formalized” by substituting for the informal constants and relations, formal symbols. This leads to a formal theory for the structure. Both of these methods yield what is called a *standard* structure and the formal theory is the *standard theory*.

For our propositional language  $L$ , we have the entire collection  $\mathcal{T}$  of sentences that are established informally in chapter 2 about this language relative to various predicates and we translate these informal statements into a formal first-order theory  $\mathcal{E}$ . One part of our mathematical analysis has been associated with

a standard structure. We have used first-order logic and a first-order language to investigate the propositional language and logic. Thousands of years of working with this structure has not produced a contradiction. The structure is composed of a domain  $D$ , where  $D = L = C$  (the set of constants). There are various  $n$ -place relations used. For example, three simplest are the 2-place relation on this domain  $\vdash'$ , the 1-place relation  $\mathcal{P}'$  that corresponds to the non-empty set of atoms  $L_0 \subset L$ , and  $x \in L$  that corresponds to  $L(x)$ . The relation  $\vdash'$  is defined as follows:  $A \vdash' B$ , where  $A, B \in L'$ , if and only if  $A \vdash B$ . Then  $\mathcal{P}'$  is defined as  $P \in \mathcal{P}'$  if and only if  $\mathcal{P}(P)$  (i.e. “ $P$  is an atom.”) Although it is not necessary, in order to have some “interesting” results, we assume that there are as many atoms as there are natural numbers. [In this case, it can be shown that there are also as many members of  $L$  as there are natural numbers.] Since  $\mathcal{E}$  is assumed consistent, then there is a standard structure  $\mathcal{M}_I = \langle D, L', \vdash', \mathcal{P}', \dots \rangle$  that models all of the  $n$ -placed predicates and constants that appear in  $\mathcal{E}$ , where we again note that for each  $A \in L$ ,  $I(A) = A$ . The set  $\mathcal{E}$  is a subset of a first-order language  $\mathcal{L}$ , where  $\mathcal{L}$  is constructed from  $C$  and all of  $n$ -placed predicates use in  $\mathcal{E}$ .

**Theorem 3.9.1** *Let  $b$  be one new constant added to the constants  $C$ . Construct a new first-order language  $\mathcal{L}'$  with the set of constants  $C \cup \{b\}$  and all of the  $n$ -placed predicates used to construct  $\mathcal{L}$ . Then  $\mathcal{L} \subset \mathcal{L}'$ . Let  $L_0$  be the set of atoms in  $L \subset C$ , where we consider them also as constants that name the atoms, and let  $x \in L_0$  be the interpretation of the 1-place predicate  $\mathcal{P}(x)$ . Consider the set of sentences  $\Phi = \{\mathcal{P}(P) \wedge b \vdash P \mid P \in L_0\} \subset \mathcal{L}'$ . Then there exists a model  ${}^*\mathcal{M}_I$  for  $\mathcal{E} \cup \Phi$ .*

Proof. This is established as in the example and exercises of section 3.8. Consider any non-empty finite  $F \subset \mathcal{E} \cup \Phi$ . Then  $F = F_1 \cup F_2$ , where  $F_1 \subset \mathcal{E}$  and  $F_2 \subset \Phi$ . Suppose that  $F_1 \neq \emptyset$ . Then  $\mathcal{M}_I \models F_1$ . Suppose that  $\{A_1, \dots, A_n\} = F_2$ ,  $n \geq 1$ . (Note:  $A_i$ ,  $1 \leq i \leq n$  are all distinct.) Consider the finite set  $\{P_1, \dots, P_n\}$  of atoms that appear in  $A_1, \dots, A_n$ . (1) If  $n = 1$ , then there is only one atom  $P$  in this set, and  $P \in D = L$ . Otherwise, (2) consider the formula formed by putting  $\wedge$  between each of the  $P_i$  as follows:  $(P_1 \wedge (\dots (P_{n-1} \wedge P_n))$  and  $(P_1 \wedge (\dots (P_{n-1} \wedge P_n)) \in D = L$ . In case (1), let  $b = P$ ; in case (2), let  $b = (P_1 \wedge (\dots (P_{n-1} \wedge P_n))$ . Then from the theory  $\mathcal{E}$ , we know that (1)  $\mathcal{P}(P) \wedge b \vdash P$  or (2)  $\mathcal{P}(P_i) \wedge b \vdash P_i$ ,  $i = 1, \dots, n$ . Hence, interpreting the  $b$  in case (1) as  $P$ , and  $b$  in case (2) as  $(P_1 \wedge (\dots (P_{n-1} \wedge P_n))$ , then  $\mathcal{M}_I \models F_1$ . Consequently,  $\mathcal{M}_I$  models any finite subset of  $\mathcal{E} \cup \Phi$ . Hence by the compactness theorem there is a model  ${}^*\mathcal{M}_I$  for  $\mathcal{E} \cup \Phi$ . ■

Let  ${}^*b$  now denote that object in the domain of  ${}^*\mathcal{M}_I$  that satisfies each of the sentences in  $\Phi$ , where  ${}^*\vdash$  denotes the corresponding binary relation that corresponds to  $\vdash$ . Since the formal theory  $\mathcal{E}$  corresponds to the informal theory  $\mathcal{T}$  and  ${}^*\mathcal{M}_I \models \mathcal{E}$ , then the structure, at the very least, behaves, as described by the theory of chapter 2, as a propositional logic. But does this new structure have additional properties? Note that  ${}^*\vdash$  “behaves” like propositional deduction and  ${}^*b$  “behaves,” thus far in this analysis, simply like a formula in  $L$ . The object  ${}^*b$  is called an *ultraword* and  ${}^*\vdash$  is an example of a (very weak) *ultrallogic*. The reason why it is weak is that we have only related  ${}^*b$  to the one relation  ${}^*\vdash$ . Hence, not much can be said about the behavior of  ${}^*b$ . However, we do know that  ${}^*b$  does not behave like an atom in  ${}^*\mathcal{M}_I$  for the following statement (3) holds in  $\mathcal{M}_I$ ; (3)  $\neg \exists x (\mathcal{P}(P_1) \wedge \mathcal{P}(P_2) \wedge \mathcal{P}(x) \wedge x \vdash P_1 \wedge x \vdash P_2)$ . Hence, (3) holds in  ${}^*\mathcal{M}_I$ . But the  $\neg \exists$  varies over the elements that, at the least, correspond to  $C \cup \{b\}$  in its domain and, hence, this statement applies to the each member of  $\{{}^*P_1, {}^*P_2\}$ , the  ${}^*\mathcal{M}_I$  interpreted constants  $P_1, P_2$ , that are members of the  ${}^*\mathcal{P}$ . Hence, whatever objects “behavior” like the atoms in  ${}^*\mathcal{M}_I$ ,  ${}^*b$  is not one of them. If we consider other predicates, then more information and properties will hold in another structure. Suppose that  $[C(\_)]$ : “ $\_$  is a consistent member of  $L$ .” In  $\Phi$ , replace  $\mathcal{P}(P)$  with  $\mathcal{P}(P) \wedge C(b)$  to obtain  $\Phi'$ . The same method as above shows that there is a structure  ${}^*\mathcal{M}_{I_1}$  such that  ${}^*\mathcal{M}_{I_1} \models \mathcal{E} \cup \Phi'$ . The previous properties for  ${}^*b$  still hold. Using the sentence  $\neg \exists x (\forall y ((\mathcal{P}(y) \wedge C(x)) \rightarrow x \vdash y))$ , we are led to the conclusion that  ${}^*b {}^*\vdash {}^*P$  in  ${}^*\mathcal{M}_{I_1}$  for all of the original atoms  $P \in L_0$ . But, when a comparison is made, there is at least one other object that we name  $d'$  that behaves like an “atom” and  ${}^*b {}^*\not\vdash d'$  in  ${}^*\mathcal{M}_{I_1}$ .

**Example 3.9.1** Correspond each atom in  $L$  to a description for the behavior of a Natural system at a specific moment. Let the ordering of the natural numbers to which each atom corresponds correspond to an ordering of an event sequence. Using the concepts of Quantum Logic, one can interpret the ultralogic  $*\vdash$  as a physical-like process that when applied to a single object  $*b$  yields each original interpreted description  $*P$ . Using certain types of special constructions that yield  $*\mathcal{M}_I$ , one has that  $*P = P$ . Hence, under these conditions this  $*b$  and  $*\vdash$  yield the moment-by-moment event sequence that is the objectively real evolution of a Natural system. This idea applies to ANY Natural system including the universe in which we dwell and, thus, gives a describable process that can produce a universe.

Obviously, the approach used to obtain ultrawords and ultralogics as discussed in this section is very crude in character. There arise numerous questions that one would like to answer. By refining the above processes, using set-theory, consequence operators and other more complex procedures these questions have all been answered. I list certain interesting ones with (very) brief answer.

(1) Can this process be refined so that the actual complex behavior expressed by each description is retained within the model while it's also being modeled by a proposition atom? (Yes)

(2) Can the ultraword  $*b$  be analyzed? (Yes, and they can have very interesting internal structures.)

(3) Can you assign a size to  $*b$  and, if so, how big is it? (Yes, and it is very, very big. It is stuffed with a great deal of information.)

(4) If you take all the ultrawords that generate all of the our Natural systems, does there exist one ultraword that when  $*\vdash$  is applied to this one ultraword then all the other ultrawords are produced and, hence, all of the event sequences for all of the Natural systems that comprise our universe are produced? (Yes. There is a ultimate ultraword  $w$  such that when  $*\vdash$  is applied to  $w$  all of the other ultrawords are produced as well as all the consequences produced by these other ultrawords. What this shows is that all natural event sequences are related by the physical-like process  $*\vdash$ , among others, applied to  $w$ . This gives a solution to the General Grand Unification problem.)

(5) Will there always be these ultranatural events no matter how we might alter the natural events? (Yes)

(6) And many others.

## APPENDIX

### Chapter 2

The major proof and definition method employed throughout this text is called *induction*. In the first part of this appendix, we'll explore this concept which is thousands of years old.

There are two equivalent principles, the weak and the strong. In most cases, the strong method is used. We use the natural numbers  $\mathbb{N} = \{0, 1, 2, 3, 4, \dots\}$  either in their entirety or starting at some fixed natural number  $m$ . There are two actual properties used. The first property is

(1) Any nonempty finite set of natural numbers contains a maximal member. This is a natural number that is greater than or equal to every member of the set and is also contained in the finite set.

(2) The ordering  $<$  is a *well-ordering*. This means that any nonempty set of natural numbers, finite or otherwise, contains a first element. This means that the set contains a member that is less than or equal to every other member of the nonempty set. The actual induction property holds for many different sets of natural numbers and you have a choice of any one of these sets. Let  $m \in \mathbb{N}$ . Then we have the set  $N_m$  of all natural numbers greater than or equal to  $m$ . That is  $N_m = \{n \mid n \in \mathbb{N}, m \leq n\}$ .

---

**Principle 1.** (Strong Induction). Suppose that you take any nonempty  $W \subset N_m$ . Then you show that a statement holds for

(i)  $m \in W$ .

(ii) Now if upon assuming that for a specific  $n \in W$ , the statement we wish to establish holds for each  $p \in \mathbb{N}$ , where  $m \leq p \leq n$ , you can show that  $n + 1 \in W$ , (this is called the strong induction hypothesis.)

(iii) then you can declare that  $W = N_m$ . (We say that the result follows by induction.)

---

The major method in applying principle 1 is in how we define the set  $W$ . It is defined in terms of the statement we wish to establish. The set  $W$  is defined by some acceptable description, a set of rules, that gives a method for *counting* objects. I have used the term "acceptable." This means a method that is so clearly stated that almost all individuals having knowledge of the terms used in the description would be able to count the objects in question and arrive at the same count. Now there is another principle that may seem to be different from principle 1, but it is actually equivalent to it.

---

**Principle 2.** (Ordinary (weak) induction.) Suppose that you take any nonempty  $W \subset N_m$ . Then you show that a statement holds for

(i)  $m \in W$ .

(ii) Now if upon assuming that for a specific  $n \in W$ , the statement we wish to establish holds  $n$ , you can show that  $n + 1 \in W$ , (this is called the weak induction hypothesis)

(iii) then you can declare that  $W = N_m$ . (We say that the result follows by induction.)

---

The difference in these two principles is located in part (ii). What you assume holds seems to be different. In principle 1, we seem to require a stronger assumption than in principle 2. The next result shows that the two principles are equivalent.

**Theorem on the equivalence of the two principles 1 and 2.** *Relative to the natural numbers and the subset  $N_m$ , principle 1 holds if and only if principle 2 holds.*

*Proof.* We first show that principle 2 is equivalent to the fact that the simple ordering  $<$  on  $N_m$  is a well-ordering. Assume principle 2 for  $N_m$ . Let nonempty  $W \subset N_m$ . Suppose that  $W$  does not have a first element with respect to the ordering  $<$ . Then  $W \neq N_m$  since  $m$  is the first element in  $N_m$ . Thus  $m \notin W$ . We now define in terms of the ordering  $<$  a relation  $R$  where the second coordinate is the set  $W$ . We let  $x R W$  if and only if for  $x \in \mathbb{N}$ ,  $x < y$  for each  $y \in W$ . Let  $W_1 = \{x \mid x \in N_m, x R W\}$ . From above, we have since  $W \subset N_m$ , that  $m \in W_1$ . Also  $W_1 \cap W = \emptyset$ . For if  $a \in W_1 \cap W$ , then  $a < a$ ; a contradiction. Assume that  $p \in W_1$  and  $q < p$ . Since  $p < n$  for each  $n \in W$ , then  $q < n$  for each  $n \in W$ . Hence  $q \in W_1$ . Hence, the nonempty natural number interval  $[m, q] = \{x \mid m \leq x \leq q, x \in \mathbb{N}\} \subset W_1$ . We now show that

$q + 1 \in W_1$ . Assume that  $q + 1 \notin W_1$ . Then there is some  $y \in W$  such that  $y \leq q + 1$  from the definition of  $W_1$ . If  $y \neq q + 1$ , then  $y \in [m, q]$  yields that  $y \notin W$ . From this contradiction, we have that  $y = q + 1$  and no  $x \leq q < q + 1$  is a member of  $W$ . Consequently,  $q + 1$  is a first element of  $W$ ; a contradiction. Application of principle 2 implies that  $W_1 = N_m$ . Thus yields the contradiction that  $W = \emptyset$ .

Now assume that  $<$  is a well-ordering. Let nonempty  $W \subset N_m$ . Assume that  $m \in W$  and if arbitrary  $n \in N_m$ , then  $n + 1 \in W$ , BUT  $W \neq N_m$ . Consider  $W_1 = N_m - W = \{x \mid x \in N_m, x \notin W\}$ . From our assumption,  $W_1 \neq \emptyset$ . By the well-ordering of  $<$ , there exists in  $W_1$  a first element  $w_1$ . Since  $m \notin W_1$ , it follows that  $m \leq x_1 - 1 \notin W_1$ . Thus  $x_1 - 1 \in W$ . From our assumption,  $x_1 - 1 + 1 = x_1 \in W$ . But by definition  $W_1 \cap W = \emptyset$ . This contradiction yields the result. The fact that  $<$ , with respect to the natural numbers, is a well-ordering is equivalent to principle 2.

Now we show that the well-ordering  $<$ , restricted to any  $N_m$ , implies principle 1 for  $N_m$ . Let nonempty  $W \subset N_m$ . Assume that  $W \neq N_m$ . Assume that  $m \in W$  and that if  $x \in W$  and  $m \leq x \leq n$ ,  $x \in N_m$ , then  $n + 1 \in W$ , but  $W \neq N_m$ . Consider  $W_1 = N_m - W_1$ . By well-ordering,  $W_1$  contains a first member  $w_1$ . From the above assumption,  $w_1 \neq m$ . Hence, we can express  $w_1$  as  $w_1 = n + 1$ , for some  $n \in \mathbb{N}$ . Since  $w_1$  is a first element, then each  $x \in N_m$  such that  $m \leq x \leq n$ , has the property that  $x \in W$ . From our principle 1 assumption, this implies that  $w_1 = n + 1 \in W$ . This contradicts the definition of  $W_1$  since  $W_1 \cap W = \emptyset$ . The result follows.

We now complete this proof by showing that principle 1 and principle 2 are equivalent. Given  $N_m$  and assume principle 2. Then  $N_m$  is well-ordered by  $<$ . From above principle 1 holds.

Now assume principle 1 holds. Let nonempty  $W \subset N_m$  and suppose that  $m \in W$  and if  $n \in W$ , then  $n + 1 \in W$ . Principle 1 states that if  $m \in W$ , and assuming that for each  $r \in \mathbb{N}$  such that  $m \leq r \leq n$ , it can be established that  $n + 1 \in W$ , then  $W = N_m$ . However, we are given that if  $n \in W$ , then  $n + 1 \in W$  and  $m \leq n \leq n$ . So, trivially, there is such an  $r = n$  and this yields that  $n + 1 \in W$ . Thus principle 1 implies that  $W = N_m$ . ■

There are two places that we use these equivalent induction processes. The first is called *definition* by induction.

---

**Principle 3** (Definition by induction) Consider a construction based upon the natural numbers  $N_m$ .

- (i) Suppose that we describe a process for the case where  $n = m$  (i.e. for step  $m$ .)
- (ii) Suppose that we assume that we have described a process for each  $n$ , where  $n \geq m$ . (i.e. each step  $n$ .)
- (iii) Now use the  $n$  notation and describe a fixed set of rules for the construction of the entity for the  $n + 1$  step. (The induction step.)

Then you have described a process that obtains each step  $n \in N_m$ .

---

**Theorem on principle 3.** *Principle 3 holds.*

Proof. Suppose that you followed the rules in (i), (ii), (iii). Let  $W \subset N_m$  be the set of all natural numbers great than or equal to  $m$  for which the construction has been described. From (i),  $m \in W$ . From (ii), we may assume that you have constructed step  $n \in W$ . From (iii), you have described step  $n + 1$  from step  $n$ . Thus  $n + 1 \in W$ . Hence by principle 2,  $W = N_m$ . ■

Notice that the concept of what is an acceptable description for a construction by induction depends upon whether the description is so clear that all individuals will obtain the same constructed object.

**Example 1.** (Definition by induction) Let  $m = 1$  and let  $b$  be a positive real number.

- (1) Define  $b^0 = 1$  and  $b^1 = b$  each being a real number.
- (2) Assume that for arbitrary  $n \in N_1$ ,  $b^n$  has been defined and is a real number.
- (3) Define  $b^{n+1} = b \cdot (b^n)$ , where  $\cdot$  means the multiplication of real numbers. (Note since  $b$  is a real number and by assumption  $b^n$  is a real number, then  $b \cdot (b^n)$  is a real number.)
- (4) Hence, by induction,  $b^n$  has been defined and is a real number for all  $n \in N_1$  (and separately for  $n = 0$ .)

In definition 2.2.3 that appears below for the language  $L$ , we use the concept of definition by induction to obtain a definition for each language level  $L_n$ . Although there are numerous examples of proof by induction within the main part of this text, here is one more example.

**Example 2.** (Proof by induction) We show that if a natural number  $n$  is greater than or equal to 2, then there exists a prime number  $p$  that is a factor of  $n$ .

Proof. Let  $m = 2$  and let  $W \subset N_m$  such that each member  $n \in W$  has a prime factor. Since 2 is a prime factor of itself, then  $2 \in W$ . Assume that for arbitrary  $n \in W$  and each  $r \in N_2$  such that  $2 \leq r \leq n$ , we know that  $r \in W$ . Now consider  $n + 1$ . If  $n + 1$  has no nontrivial factor  $b$  (i.e. not equal to 1 or  $b$ ) such that  $2 \leq b < n + 1$ , then  $n + 1$  is a prime number and, hence, contains a prime factor. (Note: any such nontrivial factor would be less than  $n + 1$ .) If  $n + 1$  has a nontrivial factor  $b$ , then  $2 \leq b < n + 1$ . Thus for this case,  $2 \leq b \leq n$ . By the induction hypotheses,  $b$  has a prime factor  $p$ . Hence  $p$  being a prime factor of  $b$  is also a prime factor of  $n + 1$ . Thus  $n + 1$  has a prime factor. Consequently,  $W = N_n$  by induction.

---

**Definition 2.2.3.** The construction by induction of the propositional language  $L$ .

- (1) Let  $\mathcal{A} = \{P, Q, R, S\} \cup (\cup\{P_i, Q_i, R_i, S_i \mid i \in \mathbb{N} - \{0\}\})$ . The set  $\mathcal{A}$  is called a set of atoms.
- (2) Let  $\emptyset \neq L_0 \subset \mathcal{A}$ .
- (3) Suppose that  $L_n$  has been defined. Let  $L_{n+1} = \{(\neg A) \mid A \in L_n\} \cup \{(A \wedge B) \mid A, B \in L_n\} \cup \{(A \vee B) \mid A, B \in L_n\} \cup \{(A \rightarrow B) \mid A, B \in L_n\} \cup \{(A \leftrightarrow B) \mid A, B \in L_n\} \cup L_n$ .
- (4) Now let  $L = \bigcup\{L_n \mid 0 \neq n \in \mathbb{N}\}$ .
- (5) Note: We are using set theoretic notation. If one wants to formalize the above intuitive ideas, the easiest way is to use a set theory with atoms where each member of  $\mathcal{A}$  is an atom. Then consider various  $L_{n+1}$  level  $n$ -ary relations, such as the  $\wedge_{n+1}$  relation defined on the  $L_n$  and for the other logical connectives. Then all nary  $\wedge_n$  relations have the same properties and the same interpretation. Because, they have the same properties and interpretation, there is nothing gained by formalizing this construction.
- (6) These formulas can also be defined in terms of the class concept, sequences of atoms, trees, closure concepts and a lot more stuff. Or, just keep them intuitive in character.

---

The next theorem holds obviously due to the inductive definition but I present it anyway.

**Theorem on uniqueness of size.** For any  $A \in L$  there exists a natural number  $n \in \mathbb{N}$  such that  $A \in L_n$  and if  $m \in \mathbb{N}$  and  $m < n$ , then  $A \notin L_m$ .

Proof. Suppose the  $A \in L$ . Then from the definition of  $L$  there exists some  $n$  such that  $A \in L_n$ . Let  $K = \{k \mid A \in L_k\}$ . Then  $\emptyset \neq K \subset \mathbb{N}$ . Hence,  $K$  has a smallest member which by definition would be the size. ■

**Theorem of the existence of a finite set of atoms that are contained in any formula  $A$ .** Let  $A \in L$ . Then there exists a finite set  $A_1$  of atoms that contains all the atoms in  $A$ .

Proof. We use strong induction.

Let  $A \in L$ . Then there exists a unique  $n$  such that  $\text{size}(A) = n$ .

(1) Let  $\text{size}(A) = 0$ . Then  $A \in L_0$  and, hence,  $A$  is a single atom. The set that contains this single atom is a finite set of atoms in  $A$ .

(2) Suppose that there exists a finite set that contains all the atoms for a formula of size  $r \leq n$ . Let  $\text{size}(A) = n + 1$ . Then from the definition of the levels either (i)  $A = \neg B$ ,  $A = B \vee C$ ,  $A = B \wedge C$ ,  $A = B \rightarrow C$ , or  $A = B \leftrightarrow C$ , where size of  $B \leq n$  and  $C \leq n$ . Hence, from the induction hypothesis, there is a finite set of atoms  $A_1$  that are contained in  $B$ , and a finite set of atoms  $A_2$  that are contained in  $C$ . Hence, there is a finite set that contains the atoms in  $A$ . Thus by induction, given any  $A \in L$ , then there exists a finite set of atoms that contains all the atoms in  $A$ . ■

**Theorem on existence of a unique assignment dependent valuation function.** There exists a function  $v: L \rightarrow \{T, F\}$  such that

- (a) if  $A \in L_0$ , then  $v(A) = F$  or  $T$  not both.
- (b) If  $A = \neg B$ , then  $v(A) = F$  if  $v(B) = T$ , or  $v(A) = T$  if  $v(B) = F$ .



- (c) If  $A = B \vee C$ , then  $v(A) = F$  if and only if  $v(B) = v(C) = F$ . Otherwise  $v(A) = T$ .  
(d) If  $A = B \wedge C$ , then  $v(A) = T$  if and only if  $v(B) = v(C) = T$ . Otherwise  $v(A) = F$ .  
(e) If  $A = B \rightarrow C$ , then  $v(A) = F$  if and only if  $v(B) = T$ ,  $v(C) = F$ . Otherwise  $v(A) = T$ .  
(f) If  $A = B \leftrightarrow C$ , then  $v(A) = T \leftrightarrow v(B) = v(C)$ . Otherwise  $v(A) = F$ .

The function  $v: L \rightarrow \{T, F\}$  is unique in the sense that if any other function  $f: L \rightarrow \{T, F\}$  has these properties and  $f(A) = v(A)$  for each  $A \in L_0$  then  $f(A) = v(A)$  for each  $A \in L$ .

Proof. (By induction). We show that for every  $n \in \mathbb{N}$  there exists a function  $v_n: L_n \rightarrow \{T, F\}$  that satisfies (a) — (f) above. Let  $n = 0$  and  $A \in L_0$ . Then define  $v_0$  by letting  $v_0(A) = T$  or  $v_0(A) = F$  not both. Then  $v_0$  is a function. Now the other properties (b) — (f) hold vacuously. Suppose there is a function  $v_n$  ( $n \neq 0$ ) defined that satisfies the properties. Define  $v_{n+1}$  as follows:  $v_{n+1}|L_n = v_n$ . Now for  $A \in L_{n+1} - L_n$ , then  $A = \neg B$ ,  $B \vee C$ ,  $B \wedge C$ ,  $b \rightarrow C$ ,  $B \leftrightarrow C$ . Thus define  $v_{n+1}(A)$  in accordance with the requirements of (b), (c), (d), (e), (f) of the above theorem. This gives a function since  $v_n$ , by the induction hypothesis, is a function on  $L_n$  and  $B, C \in L_n$  are unique members of  $L_n$ .

Now to show that for all  $n \in \mathbb{N}$ , if  $f_n: L \rightarrow \{T, F\}$  has the property that if  $f_0 = v_0$ , and (a) — (f) hold for  $f$ , then  $f_n = v_n$ . Suppose  $n = 0$ . Since  $f_0 = v_0$  property holds for  $n = 0$ . Now suppose that  $v_n$  ( $n \neq 0$ ) is unique (hence, (a) — (f) hold for  $v_n$ ) Consider,  $f_{n+1}: L \rightarrow \{T, F\}$  and (a) — (f) hold for  $f_{n+1}$ . Now  $f_{n+1}|L_n$  satisfies (a) — (f); hence  $f_{n+1}|L_n = v_n$ . Now looking at  $L_{n+1} - L_n$  and the fact that  $f$  satisfies (b) — (f), it follows that for each  $A \in L_{n+1} - L_n$ ,  $f_{n+1}(A) = v_{n+1}(A)$ . Consequently, this part holds by induction.

Now let  $v = \bigcup \{v_n \mid n \in \mathbb{N}\}$ .  $v$  is a function since for every  $n \leq m$ ,  $v_n \subset v_m$ . We show the  $v$  satisfies (a) — (f). Obviously  $v$  satisfies (a) since  $v|L_0 = v_0$ . Now if  $A = \neg B$ , then there exists  $n \in \mathbb{N}$  such that  $B \in L_n$  and  $A \in L_{n+1}$  from the existence of size of  $A$ . Then  $v(A) = v_{n+1}(A) = T$ , if  $v_n(B) = F = v(B)$  or  $v_{n+1}(A) = F$ , if  $v_n(B) = T = v(B)$ . Hence (b) holds. In like manner, it follows that (c) — (f) hold and the proof is complete. ■

It's obvious how to construct the assignment and truth-table concepts from the above theorem. If  $A$  contains a certain set of atoms, then restricting  $v$  to this set of atoms gives an assignment  $\underline{a}$ . Conversely, all assignments are generated by such a restriction. The remaining part of this theorem is but the truth-table valuation process restricted to all the formula that can be constructed from this set of atoms starting with the set  $L_0$ .

---

**Definition 2.11.1** The inductive definition for the sublanguage  $L'$  is the exact same as in the case for 2.2.3.

---

## Chapter 3

**Important Note:** All of the results established prior to theorem 3.8.4 hold for ANY predicate language.

---

**Definitions 3.1 and 3.6.1** These are obtained in the exact same manner as is 2.2.2.

---

**Theorem on the existence and uniqueness of the process  $\models$  and  $\not\models$  described in 3.3.3 on Structure Valuation.** Given a structure  $\mathcal{M}_I = \langle D, P_i^{n_i} \rangle$ , where the interpretation  $I$  is a one-to-one correspondence from  $N \subset C$  onto  $D$  and every  $n$ -place predicate  $P_i^n$  to an  $n$ -place relation  $R_i^n$ . There exists a  $v: Pd \rightarrow \{\models, \not\models\}$  such that

- (a) for each  $i \in \mathbb{N}$  and  $n \in \mathbb{N} - \{0\}$ ,  $v(P_i^n(c_1, \dots, c_n)) = \models$  if and only if  $(c'_1, \dots, c'_n) \in R_i^n$ , where for any  $c_i \in N$ ,  $I(c_i) = c'_i$ .  
(b) If  $A \rightarrow B \in Pd$ , then  $v(A \rightarrow B) = \not\models$  if and only if  $v(A) = \models$  and  $v(B) = \not\models$ . In all other cases,  $v(A \rightarrow B) = \models$ .  
(c) If  $A \leftrightarrow B \in Pd$ , then  $v(A \leftrightarrow B) = \models$  if and only if  $v(A) = \models$  and  $v(B) = \models$ , or  $v(A) = \not\models$  and  $v(B) = \not\models$ .  
(d)  $v(A \vee B) = \models$  if and only if  $v(A) = \models$  or  $v(B) = \models$ .  
(e)  $v(A \wedge B) = \models$  if and only if  $v(A) = \models$  and  $v(B) = \models$ .

(f)  $v(\neg A) = \models$  if and only if  $v(A) = \not\models$ .

In what follows, the constant  $d$  is a general constant and corresponds to a general member  $d'$  of the set  $D$ . Any constants that appear in the original predicates have been assigned FIXED members of  $D$  by  $I$  and never change their corresponding elements throughout this valuation for a given structure.

(g) For each sentence  $C = \forall xA \in Pd$ ,  $v(\forall xA) = \models$  if and only if for every  $d' \in D$  it follows that  $v(S_{d'}^x A) = \models$ . Otherwise,  $v(\forall xA) = \not\models$ .

(h) For each sentence  $C = \exists xA \in Pd$ ,  $v(\exists xA) = \models$  if and only if there is some  $d' \in D$  such that  $v(S_{d'}^x A) = \models$ . Otherwise,  $v(\exists xA) = \not\models$ .

The function  $v$  is unique in the sense that if any other function  $f: Pd \rightarrow \{\models, \not\models\}$  such that  $f = v$  for the statements in (a), then  $f = v$ , in general.

Proof. The proof is by induction in the language levels  $m$ . Let  $m = 0$ . Define  $v_0: Pd_0 \rightarrow \{\models, \not\models\}$  by condition (a) for all the predicates. Then  $v_0$  satisfies (b) – (h) vacuously.

Suppose that  $v_m: Pd_m \rightarrow \{\models, \not\models\}$  exists and satisfies (a) – (h). Define  $v_{m+1}: Pd_{m+1} \rightarrow \{\models, \not\models\}$  as follows:  $v_{m+1}|Pd_m = v_m$ . For  $F \in Pd_{m+1} - Pd_m$ , then  $F = \neg A$ ,  $A \wedge B$ ,  $A \vee B$ ,  $A \leftrightarrow B$ ,  $\forall xA$ ,  $\exists xA$ , where  $A$ ,  $B \in Pd_m$ . Now define for the specific  $F$  listed, the function by the appropriate conditions listed in (b) – (h). We note that  $A$ ,  $B$  are unique and this defines a function.

We show that each  $v_m$  is a unique function  $f: Pd_m \rightarrow \{\models, \not\models\}$  satisfying (a) – (h) by induction. If  $f$  is another such function, then letting  $m = 0$  condition (a) implies that  $f = v_0$ . Assume that  $v_m$  is unique. Let  $f: Pd_{m+1} \rightarrow \{\models, \not\models\}$  and  $f$  satisfies (a) – (h). Then  $f|Pd_m = g$  satisfies (a) – (h). Therefore,  $g = v_m$ . Now (b) – (h), yields that  $f = v_{m+1}$ .

The remainder of this proof follows in the exact same manner as the end of the proof of the **Theorem on existence of a unique assignment dependent valuation function.** ■

NOTE: In the remaining portion of this appendix, it will be assumed that our language contains a non-empty countable set of constants  $\mathcal{C}$ .

We need for the proof of theorem 3.8.5 another conclusion. A set of sentences  $\Gamma$  is *universal* for a language  $Pd'$  if and only if  $\forall xB \in \Gamma$ , whenever  $S_d^x B \in \Gamma$  for all  $d \in \mathcal{C}$ .

**Theorem 3.8.4** *If consistent  $\Gamma \subset \mathcal{S}$ , then there is a language  $Pd''$  that contains all of the symbols of  $Pd'$ , but with an additional set of constants and only constants adjoined, and a set of sentences  $\Gamma'' \subset Pd''$  such that  $\Gamma \subset \Gamma''$  and  $\Gamma''$  is consistent, negation complete, and universal.*

Proof. First, we extend  $\mathcal{C}$  by adjoining a new denumerable set of constants  $\{b_0, \dots\}$  to  $\mathcal{C}$  giving a new language  $Pd''$ . [For other languages, the set of new constants may need to be a “larger” set than this.] This means that the set of sentences  $\mathcal{S}'$  for  $Pd''$  is denumerable and we can consider them as enumerated into an infinite sequence  $S_1, S_2, \dots$  and these are all of the members of  $\mathcal{S}'$ . We now begin an inductive definition for an extension of  $\Gamma_n$  by adjoining a finite set of sentences from  $S_1, S_2, \dots$  which could mean that only finitely many members of  $\{b_0, \dots\}$  would appear in an any  $\Gamma_n$ .

First, for  $n = 0$ , let  $\Gamma_0 = \Gamma$ . Suppose that  $\Gamma_n$  has been defined. We now define  $\Gamma_{n+1}$ .

- (a) If  $\Gamma_n \cup \{S_{n+1}\}$  is consistent, then let  $\Gamma_{n+1} = \Gamma_n \cup \{S_{n+1}\}$ .
- (b) If  $\Gamma_n \cup \{S_{n+1}\}$  is inconsistent and  $S_{n+1}$  is NOT of the form  $\forall xB$ , then let  $\Gamma_{n+1} = \Gamma_n \cup \{\neg S_{n+1}\}$ .
- (c) If  $\Gamma_n \cup \{S_{n+1}\}$  is inconsistent and  $S_{n+1}$  is of the form  $\forall xB$ , then let  $\Gamma_{n+1} = \Gamma_n \cup \{\neg S_{n+1}, \neg S_b^x B\}$ , where  $b$  is the first constant in  $\{b_0, \dots\}$  that does not appear in  $\Gamma_n$ .

We first show that for each  $n$  the set of sentences  $\Gamma_n$  is consistent. Obviously, for  $n = 0$ , the result follows from the hypothesis that  $\Gamma = \Gamma_0$  is consistent. Now assume that  $\Gamma_n$  is consistent.

- (a)' Suppose that  $\Gamma_{n+1}$  is obtained from case (a). Then  $\Gamma_{n+1}$  is consistent.
- (b)' Suppose that  $\Gamma_{n+1}$  is obtained from case (b). Then  $\Gamma_n \cup \{S_{n+1}\}$  is inconsistent. Hence, from corollary 3.8.3.1,  $\Gamma_n \vdash \neg S_{n+1}$ . Now  $\Gamma_{n+1} = \Gamma_n \cup \{\neg S_{n+1}\}$ . Suppose that  $\Gamma_n \cup \{\neg S_{n+1}\}$  is inconsistent. Then corollary 3.8.3.1 yields that  $\Gamma_n \vdash S_{n+1}$ . Hence,  $\Gamma_n$  is inconsistent. This contradiction yields that  $\Gamma_{n+1}$  is consistent.

(c)' Again  $\Gamma_n \cup \{S_{n+1}\}$  is inconsistent yields that  $\Gamma_n \vdash \neg S_{n+1}$ . Now also suppose that  $\Gamma_{n+1} = \Gamma \cup \{\neg S_{n+1}, \neg S_b^x B\}$ , where  $b$  is the first member of new constants that does not appear in  $\Gamma_n$  and assume that this is an inconsistent collection of sentences. Then for some  $C \in Pd''$  we have that  $\Gamma_n \cup \{\neg S_{n+1}, \neg S_b^x B\} \vdash C$  and  $\Gamma_n \cup \{\neg S_{n+1}, \neg S_b^x B\} \vdash \neg C$ . Then by the deduction theorem 3.7.4,  $\Gamma_n \cup \{\neg S_b^x B\} \vdash (\neg S_{n+1}) \rightarrow C$  and  $\Gamma_n \cup \{\neg S_b^x B\} \vdash (\neg S_{n+1}) \rightarrow (\neg C)$ . Then by adjoining the proof that  $\Gamma_n \vdash \neg S_{n+1}$  and two MP steps we have that  $\Gamma_n \cup \{\neg S_b^x B\}$  is inconsistent. Thus by corollary 3.8.1,  $\Gamma_n \vdash \neg S_b^x B$ . Now the constant  $b$  does not occur anywhere in  $\Gamma_n$ . Thus in the last demonstration we may substitute for  $b$  some variable  $y$  that does not appear anywhere in the demonstration for each occurrence of  $b$ . This yields a demonstration that  $\Gamma_n \vdash S_y^x B$ . By Generalization,  $\Gamma_n \vdash \forall y(S_y^x B)$ . By corollary 3.6.3.1, we have that  $\Gamma_n \vdash \forall x B = S_{n+1}$ . This contradicts the consistency of  $\Gamma_n$ . Since this is the last possible case, then  $\Gamma_{n+1}$  is consistent. Thus by induction for all  $n$ ,  $\Gamma_n$  is consistent.

We note that by definition  $\Gamma = \Gamma_0 \subset \Gamma_1 \subset \dots \subset \Gamma_n \subset \dots$ . We now define  $\Gamma'' = \bigcup \{\Gamma_n \mid n \in \mathbb{N}\}$ . We need to show that  $\Gamma''$  is consistent, negation complete and universal for  $Pd''$ .

(1) Suppose that the set of sentences  $\Gamma''$  is inconsistent. Then there is finite subset  $F$  of  $\Gamma''$  that is inconsistent. But, from our remark above, there is some  $m \in \mathbb{N}$  such that  $F \subset \Gamma_m$ . This implies that  $\Gamma_m$  is inconsistent. From this contradiction, we have that  $\Gamma''$  is consistent. [In fact, its maximally consistent, in that adjoining any sentence to  $\Gamma''$  that is not in  $\Gamma''$ , we get an inconsistent set of sentences.]

(2) The set  $\Gamma''$  is negation complete. Let  $A$  be any sentence in  $Pd''$ . Then  $A$  is one of the  $S_{n+1}$ , where  $n \in \mathbb{N}$ . From definition (a), (b), (c), either  $S_{n+1} \in \Gamma_{n+1}$  or  $\neg S_{n+1} \in \Gamma_{n+1}$ . Thus  $\Gamma''$  is negation complete.

(3) We now show that  $\Gamma''$  is universal. Let  $\forall x B$  be a sentence in  $Pd''$  such that  $S_c^x B \in \Gamma''$  for each  $c \in \mathcal{C} \cup \{b_0, \dots\}$ . Suppose that  $\forall x B \notin \Gamma''$ . We know that  $\forall x B = S_{n+1}$  for some  $n \in \mathbb{N}$ . By case (a),  $\Gamma_n \cup \{\forall x B\}$  is inconsistent, by negation completeness,  $\neg \forall x B \in \Gamma''$ . Now case (c) applies and  $\Gamma_{n+1} = \Gamma_n \cup \{\neg S_{n+1}, \neg S_b^x B\} \subset \Gamma''$ . This implies that  $\neg S_b^x B \in \Gamma''$ . But our assumption was that  $S_c^x B \in \Gamma''$  for all constants in  $Pd''$ . Since  $b$  is one of these constants, we have a contradiction. Thus  $\forall x B \in \Gamma''$ . ■

Prior to establishing our major theorem 3.8.5, we have the following Lemma and the method to construct the model we seek. Let the domain of our structure  $D = \mathcal{C}$  for a specific  $Pd'$ . Let  $\Gamma$  be any non-empty set of sentences from the language  $Pd'$ . For every  $n$ -place predicate  $P_i^n$  in  $Pd'$ , we define the  $n$ -place relation  $R_i^n$  by  $(c_1, \dots, c_n) \in R_i^n$  if and only if  $P(c_1, \dots, c_n) \in \Gamma$ . We denote the structure obtained from this definition by the notation  $\mathcal{M}_I(\Gamma)$ .

**Lemma 3.8** *Let  $\Gamma$  be a consistent, negation complete and universal set of sentences from  $Pd'$ . Then for any sentence  $A \in Pd'$ ,  $\mathcal{M}_I(\Gamma) \models A$  if and only if  $A \in \Gamma$ .*

Proof. This is established by induction on the size of a formula.

(a) For  $n = 0$ . Let sentence  $A \in Pd'_0$ . The result follows from the definition of  $\mathcal{M}_I(\Gamma)$ .

(b) Suppose that theorem holds for  $n$ . Suppose that  $A \in Pd'_{n+1}$ . Assume that  $A = B \rightarrow C$ . Then  $B, C \in Pd'_n$ . We may assume by induction that the lemma holds for  $B$  and  $C$ . Suppose that  $A \notin \Gamma$ . From negation completeness,  $\neg A \in \Gamma$ . But, in general,  $\neg(B \rightarrow C) \vdash B$  and  $\neg(B \rightarrow C) \vdash \neg C$ . Hence,  $\Gamma \vdash B$  and  $\Gamma \vdash \neg C$ . If  $\neg B \in \Gamma$ ,  $\Gamma$  is inconsistent. Then, from negation completeness, it must be that  $B \in \Gamma$ . For the same reasons,  $\neg C \in \Gamma$  and, thus,  $C \notin \Gamma$ . From the induction hypothesis,  $\mathcal{M}_I(\Gamma) \models B$  and  $\mathcal{M}_I(\Gamma) \not\models C$ . Thus  $\mathcal{M}_I(\Gamma) \not\models A$ . Conversely, assume that  $\mathcal{M}_I(\Gamma) \not\models A$ . Then  $\mathcal{M}_I(\Gamma) \models B$  and  $\mathcal{M}_I(\Gamma) \not\models C$ . By the induction hypothesis,  $B \in \Gamma$  and  $C \notin \Gamma$ . By negation completeness,  $\neg C \in \Gamma$ . From,  $B, \neg C \vdash \neg(B \rightarrow C)$ , we have that  $\Gamma \vdash \neg(B \rightarrow C)$ . Again by negation completeness and consistency, it follows that  $\neg(B \rightarrow C) \in \Gamma$ . Hence,  $\neg A \in \Gamma$  and  $A \notin \Gamma$ .

(c) Let the sentence be  $A = \forall x B$ . Suppose that  $\mathcal{M}_I(\Gamma) \models A$ . Then for each  $d \in D$ ,  $\mathcal{M}_I(\Gamma) \models S_d^x B$ . By the induction hypothesis, since  $S_d^x B \in Pd'_n$ , then  $S_d^x B \in \Gamma$ . Since  $\Gamma$  is universal,  $\forall x B = A \in \Gamma$ . Conversely, let  $A \in \Gamma$ . Now, in general,  $A \vdash S_d^x B$  implies that  $\Gamma \vdash S_d^x B$ , which implies again by negation completeness and consistency that  $S_d^x B \in \Gamma$  for each  $d \in D$ . By the induction hypothesis, we have that  $\mathcal{M}_I(\Gamma) \models S_d^x B$  for each  $d \in D$ . From the definition of  $\models$ , we have that  $\mathcal{M}_I(\Gamma) \models A$ .

This completes the proof. ■

---

---

**Theorem 3.8.5** *If consistent  $\Gamma \subset \mathcal{S}$ , then there exists a structure  $\mathcal{M}_I$  for  $\Gamma$  such that  $\Gamma \vdash A$  if and only if  $\mathcal{M}_I \models \forall A$ .*

Proof. Let the consistent set of sentences  $\Gamma \subset Pd'$ . Then the language  $Pd'$  can be extended to a language  $Pd''$  and the set of sentences  $\Gamma$  extended to a set of sentences  $\Gamma''$  such that  $\Gamma''$  is consistent, negation complete, and universal. Assume that  $\Gamma \vdash A$ . Then  $\Gamma \vdash \forall A$ . Consequently,  $\Gamma'' \vdash \forall A$ . Thus  $\forall A \in \Gamma''$ . Now we use the structure  $\mathcal{M}_I(\Gamma'')$ . Then lemma 3.8 states that  $\mathcal{M}_I(\Gamma'') \models \forall A$ , where  $\mathcal{M}_I(\Gamma'')$  is considered as restricted to  $Pd'$  since  $\forall A \in Pd'$ .

Now suppose that  $\Gamma \not\vdash A$ . Then by repeated application of  $P_5$  and MP, we have that  $\Gamma \not\vdash \forall A$ . [See theorem 3.6.4.] Thus  $\Gamma \cup \{\neg(\forall A)\}$  is consistent by theorem 3.8.2. Consequently,  $\neg(\forall A) \in \Gamma''$ . Therefore,  $\mathcal{M}_I(\Gamma'') \models \neg(\forall A)$  implies that  $\mathcal{M}_I(\Gamma'') \not\models \forall A$ . Again, by restriction to the language  $Pd'$ , the converse follows. ■

---

---

Answers to Some of the Exercise Problems

Exercise 2.2, Section 2.2

- [1] (a)  $A \notin L$ . A required “)” is missing. (b)  $A \in L$ . (c)  $A \in L$ . (d)  $A \notin L$ . The error is the symbol ( $P$ ). (e)  $A \notin L$ . Another parenthesis error. (f)  $A \notin L$ . The symbol string “)P)” is in error. (g)  $A \in L$ . (h)  $A \notin L$ . Parenthesis error. (i)  $A \notin L$ . Parenthesis error. (j)  $A \notin L$ . Parenthesis error.
- [3] (a)  $(P \vee Q)$ . (b)  $(P \rightarrow (Q \vee R))$ . (c)  $(P \wedge (Q \vee R))$ . (d)  $(Q \vee R)$ . (e)  $((P \wedge Q) \vee R)$ . (f)  $\neg(P \vee Q)$ . (g)  $((P \leftrightarrow Q) \wedge ((\neg Q) \rightarrow (R \wedge S)))$ . (h)  $((P \vee Q) \rightarrow R)$ . (i)  $((P \wedge Q) \rightarrow R) \wedge ((\neg P) \rightarrow (\neg R))$ .
- [4] (a) If it is nice, then it is not the case that it is hot and it is cold.  
 (b) It is small if and only if it is nice.  
 (c) It is small, and it is nice or it is hot.  
 (d) If it is small, then it is hot; or it is nice.  
 (e) It is nice if and only if; it is hot and it is not cold, or it is small. [It may be difficult to express this thought nonambiguously in a single sentence unless this “strange” punctuation is used. The “;” indicates a degree of separation greater than a comma but less than a period.]  
 (f) If it is small, then it is hot; or it is nice.

Exercise 2.3, Section 2.3

- [1] (a) The number of (not necessarily distinct connectives) = the number of common pairs.  
 (b) The number of subformula = the number of common pairs.
- [2] (No problem, sorry!)
- [3] (A) has common pairs (a,h), (b,e), (c,d), (f,g).  
 (B) has common pairs (a,m), (b,g), (c,f), (d,e), (h,k), (i,j).  
 (C) has common pairs (a,q), (b,p), (d,g), (e,f), (i,o), (j,k), (m,n), (c,h).

Exercise 2.4, Section 2.4

- [1]. First, we the assignment  $\underline{a} = (T, F, F, T) \leftrightarrow (P, Q, R, S)$ .
- (a)  $v((R \rightarrow (S \vee P)), \underline{a}) = (F \rightarrow (T \vee T)) = (F \rightarrow T) = F$ .  
 (b)  $v(((P \vee R) \leftrightarrow (R \wedge (\neg S))), \underline{a}) = ((T \vee F) \leftrightarrow (F \wedge (\neg T))) = (T \leftrightarrow (F \wedge F)) = F$ .  
 (c)  $v((S \leftrightarrow (P \rightarrow ((\neg P) \vee S))), \underline{a}) = (T \leftrightarrow (T \rightarrow ((\neg T) \vee T))) = (T \leftrightarrow (T \rightarrow T)) = (T \leftrightarrow T) = T$ .  
 (d)  $v((((\neg S) \vee Q) \rightarrow (P \leftrightarrow S)), \underline{a}) = (((\neg T) \vee F) \rightarrow (T \leftrightarrow T)) = (F \leftrightarrow T) = T$ .  
 (e)  $v((((P \vee (\neg Q)) \vee R) \rightarrow ((\neg S) \wedge S)), \underline{a}) = (((T \vee (\neg F)) \vee F) \rightarrow ((\neg T) \wedge T)) = (((T \vee T) \vee F) \rightarrow F) = (T \rightarrow F) = F$ .
3. (a)  $(P \rightarrow Q) \rightarrow R$ ,  $v(R) = T \Rightarrow ((P \rightarrow Q) \rightarrow T) = T$  always.  
 (b)  $P \wedge (Q \rightarrow R)$ ,  $v(Q \rightarrow R) = F \Rightarrow (P \wedge F) = F$  always.  
 (c)  $(P \rightarrow Q) \rightarrow ((\neg Q) \rightarrow (\neg P))$ ,  $v(Q) = T \Rightarrow (P \rightarrow T) \rightarrow (F \rightarrow (\neg P)) = T \rightarrow T = T$  always.  
 (d)  $(R \rightarrow Q) \leftrightarrow Q$ ,  $v(R) = T \Rightarrow (T \rightarrow Q) \leftrightarrow Q = T$  always.  
 (e)  $(P \rightarrow Q) \rightarrow R$ ,  $v(Q) = F \Rightarrow (P \rightarrow F) \rightarrow R = T$  or  $F$ .  
 (f)  $(P \vee (\neg P)) \rightarrow R$ ,  $v(R) = F \Rightarrow (P \vee (\neg P)) \rightarrow F = T \rightarrow F = F$  always.

Assignment 4 Section 2.5

[1].

P	Q	R	$Q \rightarrow P$	(1)	$Q \rightarrow R$	$P \rightarrow (Q \rightarrow R)$	$P \rightarrow R$	$P \rightarrow Q$
T	T	T	T	T	T	T	T	T
T	T	F	T	T	F	F	F	T
T	F	T	T	T	T	T	T	F
T	F	F	T	T	T	T	F	F
F	T	T	F	T	T	T	T	T
F	T	F	F	T	F	T	T	T
F	F	T	T	T	T	T	T	T
F	F	F	T	T	T	T	T	T

$(P \rightarrow Q) \rightarrow (P \rightarrow R)$	(2)	$\neg P$	$\neg Q$	$(\neg P) \rightarrow (\neg Q)$	(21)
T	T	F	F	T	T
F	T	F	F	T	T
T	T	F	T	T	T
T	T	F	T	T	T
T	T	T	F	F	T
T	T	T	F	F	T
T	T	T	T	T	T
T	T	T	T	T	T

Now use Theorem 2.5.2, with  $P = A$ ,  $Q = B$ ,  $R = C$ .

[2] (a) A contradiction. (b) Not a contradiction. (c) A contradiction. (d) Not a contradiction.

Exercise 2.6, Section 2.6

[1] (A) Suppose that we assume that there is some  $z \in [x] \cap [y]$ . Then we have that  $z \equiv x$ ,  $z \equiv y$ . But symmetry yields that  $x \equiv z$ . From the transitive property, we have that  $x \equiv y$ . Hence  $x \in [y]$ . Now let  $u \in [x]$ . Then  $u \equiv x \Rightarrow u \equiv y$ . Thus  $u \in [y]$ . Thus  $[x] \subset [y]$ . Since  $y \equiv x$ , this last argument repeated for  $y$  shows that  $[y] \subset [x]$ . Hence  $[x] = [y]$ .

(B) Well, just note that for each  $x \in X$  it follows that  $x \equiv x$ . Hence, from the definition,  $x \in [x]$ .

[2] (A) Since  $B$  is a binary relation on  $X$ , it is defined for all members of  $B$ . We are given that  $B$  is reflexive. Thus we need to show that it is transitive and symmetric. So, let  $xBy$ . Then  $x \in (y)$ . From reflexive, we

have that  $x \in (x)$ . From (A), we have that  $(x) = (y)$ . Thus  $y \in (x)$ . Therefore,  $yBx$ . Thus yields that  $B$  is symmetric.

To show that it is transitive, assume that since  $B$  is on the entire set  $X$ , that  $x \in y$ ,  $y \in (z)$ . Then from the reflexive property,  $y \in (y)$ . Hence  $y \in (y) \cup (z)$ . Thus  $(y) = (z)$  from (A). Thus  $xBz$ . Re-writing this in relation notation we, have that if  $xBy$  and  $yBz$ , then  $xBz$ . This  $B$  is an equivalence relation.

(B) To show that reflexive is necessary, consider the binary relation  $R = \{(a, b), (b, a)\}$  on the two element set  $\{a, b\}$ . Note that is can be re-written as  $aRb$ ,  $bRa$ . Then  $(b) = \{a\}$ ,  $(a) = \{b\}$ . Now this relation satisfies (A) vacuously (i.e (A) holds since that hypothesis never holds.) (B) is obvious. But, since neither  $(a, a)$  nor  $(b, b)$  are members of  $R$ , then  $R$  is not an equivalence relation.

- [3] (A) Let  $D = (A \vee (A \vee B))$ ,  $E = ((A \vee B) \vee C)$ . Now from (3) Theorem 2.5.3, we have that  $C_D \equiv C_E$ .  
 (B) Let  $D = (A \vee B)$ ,  $E = ((\neg A) \rightarrow B)$ . Then from part (46) of Theorem 2.5.3, we have that  $C_D \equiv C_E$ .  
 (C) Let  $D = (A \wedge B)$ ,  $E = (\neg(A \rightarrow (\neg B)))$ . The part (43) of Theorem 2.5.3, yields this result.  
 (D) First, let  $D = (A \leftrightarrow B)$ . Let  $G = (A \rightarrow B) \wedge (B \rightarrow C)$ . Then from part (47) of Theorem 2.5.3, we have that  $C_D \equiv C_G$ . We can now apply (C) twice, and let  $E = (\neg((A \rightarrow B) \rightarrow (\neg(B \rightarrow C))))$ . This yields  $C_D \equiv D_E$ .

(E) This actually requires a small induction proof starting at  $n = 0$ . Let  $n$  be the number of  $\neg$  to the left of  $A$ . If  $n = 0$  or  $n = 1$ , then the property that there is either none or one such  $\neg$  symbol to the left is established. Suppose that we have already established this for some  $n > 1$ . Now let there be  $n+1$  such symbols to the left of  $A$  and let this formula be denoted by  $H$ . First, consider the subformula  $G$  such that  $\neg G = H$ . Then by the induction hypothesis, there is a formula  $K$  such that  $K$  contains no  $\neg$  to the left or at the most one  $\neg$  to the left such that  $K \equiv G$ . If  $K$  has no  $\neg$  to the left, then  $C_H = C_{\neg G} \equiv C_{\neg K} \Rightarrow C_H \equiv C_{\neg K}$ . Now if  $K$  has one  $\neg$  to the left, then, in like manner,  $C_H \equiv C_{\neg(\neg K)} \equiv C_K \Rightarrow C_H \equiv C_K$ , where  $K$  has no  $\neg$  symbols. The result follows by induction.

#### Exercise 2.7, Section 2.7

- [1] (a)  $P \leftrightarrow (A \rightarrow (R \vee S)) \equiv ((\neg P) \vee (A \rightarrow (R \vee S))) \wedge ((\neg(A \rightarrow (R \vee S))) \vee P) \equiv ((\neg P) \vee ((\neg A) \vee (R \vee S))) \wedge ((\neg(\neg A) \vee (R \vee S))) \vee P \equiv ((\neg P) \vee ((\neg A) \vee (R \vee S))) \wedge (A \wedge ((\neg R) \wedge (\neg S))) \vee P$ .  
 (b)  $((\neg P) \rightarrow Q) \leftrightarrow R \equiv (((\neg P) \rightarrow Q) \rightarrow R) \wedge (R \rightarrow ((\neg P) \rightarrow Q)) \equiv (\neg((\neg P) \vee Q) \rightarrow R) \wedge ((\neg R) \vee (\neg(\neg P) \vee Q)) \equiv ((P \vee Q) \rightarrow R) \wedge ((\neg R) \vee (P \vee Q)) \equiv ((\neg(P \vee Q)) \vee R) \wedge ((\neg R) \vee (P \vee Q)) \equiv (((\neg P) \wedge (\neg Q)) \vee R) \wedge ((\neg R) \vee (P \vee Q))$ .  
 (c)  $(\neg((\neg P) \vee (\neg Q))) \rightarrow R \equiv (P \wedge Q) \rightarrow R \equiv (\neg(P \wedge Q)) \vee R \equiv ((\neg P) \vee (\neg Q)) \vee R$ .  
 (d)  $((\neg P) \leftrightarrow Q) \rightarrow R \equiv (\neg((\neg P) \leftrightarrow Q)) \vee R \equiv (\neg(((\neg P) \rightarrow Q) \wedge (Q \rightarrow (\neg P)))) \vee R \equiv ((\neg(\neg(\neg P))) \wedge (\neg Q)) \vee Q \vee ((\neg Q) \vee (\neg P)) \vee R \equiv (((\neg P) \wedge (\neg Q)) \vee Q) \vee ((\neg Q) \vee (\neg P)) \vee R$ .  
 (e)  $(S \vee Q) \rightarrow R \equiv (\neg(S \vee Q)) \vee R \equiv ((\neg S) \wedge (\neg Q)) \vee R$ .  
 (f)  $(P \vee (Q \wedge S)) \rightarrow R \equiv ((\neg P) \wedge ((\neg Q) \vee (\neg S))) \vee R$ .
- [2] (a)  $((\neg P) \vee Q) \wedge (((\neg Q) \vee P) \wedge R) \Rightarrow A_d = (P \wedge (\neg Q)) \vee ((Q \wedge (\neg P)) \vee (\neg R))$   
 (b)  $((P \vee (\neg Q)) \vee R) \wedge (((\neg P) \vee Q) \wedge R) \Rightarrow A_d = (((\neg P) \wedge Q) \wedge (\neg R)) \vee ((P \wedge (\neg Q)) \vee (\neg R))$ .  
 (c)  $((\neg R) \vee (\neg P)) \wedge (Q \wedge P) \Rightarrow A_d = (R \wedge P) \vee ((\neg Q) \vee (\neg P))$   
 (d)  $((Q \wedge (\neg R)) \vee Q) \vee (\neg P) \wedge (Q \vee R) \Rightarrow A_d = (((\neg Q) \vee R) \wedge (\neg Q)) \wedge P \vee ((\neg Q) \wedge (\neg R))$ .
- [3] (a)  $(P \wedge Q \wedge R) \vee (P \wedge (\neg Q) \wedge R) \vee (P \wedge (\neg B) \wedge (\neg C))$ .  
 (b)  $(P \wedge Q \wedge R) \vee (P \wedge Q \wedge (\neg R)) \vee (P \wedge (\neg Q) \wedge (\neg R)) \vee ((\neg P) \wedge Q \wedge R) \vee ((\neg P) \wedge Q \wedge (\neg R)) \vee ((\neg P) \wedge (\neg Q) \wedge R) \vee ((\neg P) \wedge (\neg Q) \wedge (\neg R))$ .  
 (c)  $(P \wedge Q \wedge (\neg R)) \vee (P \wedge (\neg Q) \wedge (\neg R)) \vee ((\neg P) \wedge Q \wedge (\neg R)) \vee ((\neg P) \wedge (\neg Q) \wedge R)$ .  
 (d)  $(P \wedge Q \wedge R) \vee (P \wedge Q \wedge (\neg R)) \vee (P \wedge (\neg Q) \wedge R) \vee (P \wedge (\neg Q) \wedge (\neg R)) \vee ((\neg P) \wedge Q \wedge R) \vee ((\neg P) \wedge Q \wedge (\neg R)) \vee ((\neg P) \wedge (\neg Q) \wedge R) \vee ((\neg P) \wedge (\neg Q) \wedge (\neg R))$ .
- [5] (a)  $C \wedge (A \vee (B \wedge ((\neg A) \vee B)))$ .  
 (b)  $(C \vee ((A \vee B) \wedge (\neg(A \wedge B)))) \wedge (\neg(C \wedge ((A \vee B) \wedge (\neg(A \wedge B)))))$ .

#### Exercise 2.8, Section 2.8

- [1].  
 (a)  $P \rightarrow Q, (\neg P) \rightarrow Q \models Q$ .  
 (b)  $P \rightarrow Q, Q \rightarrow R, P \models R$ .

- (c)  $(P \rightarrow Q) \rightarrow P, \neg P \models R$ . (Since premises are not satisfied,  $\models$  holds.)  
 (d)  $(\neg P) \rightarrow (\neg Q), P \not\models Q$ . (From row three.)  
 (e)  $(\neg P) \rightarrow (\neg Q), Q \models P$ .

*Exercise 2.9, Section 2.9*

[1]. (a)  $(\neg A) \vee B, C \rightarrow (\neg B) \models A \rightarrow C$ .

(1)  $v(A \rightarrow C) = F \Rightarrow v(A) = T, v(C) = F \Rightarrow v(C \rightarrow (\neg B)) = T$ . Now (3), if  $v(B) = T$ , then  $v((\neg A) \vee B) = T$ . Consequently, **INVALID**. AND the letters represent atoms only.

(b)  $A \rightarrow (B \rightarrow C), (C \wedge D) \rightarrow E, (\neg G) \rightarrow (D \wedge (\neg E)) \models A \rightarrow (B \rightarrow G)$ .

(1) Let  $v(A \rightarrow (B \rightarrow G)) = F \Rightarrow v(A) = T, v(B \rightarrow G) = F \Rightarrow v(B) = T, v(G) = F$ . (2) Let  $v(A \rightarrow (B \rightarrow C)) = T \Rightarrow v(C) = T$ . (3) Let  $v((\neg G) \rightarrow (D \wedge (\neg E))) = T \Rightarrow v(D \wedge (\neg E)) = F \Rightarrow v(D) = F, v(E) = T \Rightarrow v((C \vee D) \rightarrow E) = F$ . Hence, **VALID**.

(c)  $(A \vee B) \rightarrow (C \wedge D), (D \vee E) \rightarrow G \models A \rightarrow G$ .

(1) Let  $v(A \rightarrow G) = F \Rightarrow v(G) = F, v(A) = T$ . (2) Let  $v((D \vee E) \rightarrow G) = T \Rightarrow v(D) = v(E) = F \Rightarrow v((A \vee B) \rightarrow (C \wedge D)) = F$ . Hence, **VALID**.

(d)  $A \rightarrow (B \wedge C), (\neg B) \vee D, (E \rightarrow (\neg G)) \rightarrow (\neg D), B \rightarrow (A \vee (\neg E)) \models B \rightarrow E$ .

(1) Let  $v(B \rightarrow E) = F \Rightarrow v(B) = T, v(E) = F$ . (2) Let  $v((\neg B) \vee D) = T \Rightarrow v(D) = T \Rightarrow v((E \rightarrow (\neg G)) \rightarrow (\neg D)) = F$ . Hence **VALID**.

[2] (a) The argument is  $H \vee S, (\neg H) \models S$ . Let  $v(S) = F$ . Let  $v(\neg H) = T \Rightarrow v(H) = F \Rightarrow v(H \vee S) = F$ . Hence, **VALID**.

(b) The argument is  $I \rightarrow C, (\neg I) \rightarrow D \models C \vee D$ . (1) Let  $v(C \vee D) = F \Rightarrow v(C) = v(D) = F$ . (2) Let  $v((\neg I) \rightarrow D) = T \Rightarrow v(I) = T \Rightarrow v(I \rightarrow C) = F$ . Hence, **VALID**.

(c) The argument is  $S \rightarrow I, I \rightarrow C, S \models C$ . (1) Let  $v(C) = F$ . (2) Let  $v(S) = T$ . (3) Let  $v(S \rightarrow I) = T \Rightarrow v(I) = T \Rightarrow v(I \rightarrow C) = F$ . Hence, **VALID**.

(d) The argument is  $P \rightarrow L, L \rightarrow N, N \models P$ . (1) Let  $v(P) = F \Rightarrow v(P \rightarrow L) = T$ . (2) Let  $v(N) = T \Rightarrow v(L \rightarrow N) = T$ . Hence, **INVALID**.

(e) The argument is  $W \vee C, W \rightarrow R, N \models W$ . (1) Let  $v(W) = F \Rightarrow v(W \rightarrow R) = T$ . We have only one more premise remaining. This is NOT forced to be anything. We should be able to find values that will make it  $T$ . Let  $v(C) = T \Rightarrow v(W \vee C) = T$ . Hence **INVALID**. [Note this is an over determined argument. The statement  $N$  if removed will still lead to an invalid argument. However, if we add the premises  $N \rightarrow W$ , then the argument is valid.

(f) The argument is  $C \rightarrow (M \rightarrow I), C \wedge (\neg M) \models \neg I$ . (1) Let  $v(\neg I) = F \Rightarrow v(I) = T \Rightarrow v(C \rightarrow (M \rightarrow I)) = T$ , independent of the values for  $C, M$ . Thus for  $v(C) = T, v(M) = F \Rightarrow v(C \wedge (\neg M)) = T$ . Hence, **INVALID**.

(g) The argument is  $(L \vee C) \rightarrow (D \wedge S), D \rightarrow P, \neg P \models L$ . (1) Let  $v(L) = F$ . (2) Let  $v(\neg P) = T \Rightarrow v(P) = F$ . (3) Let  $v(D \rightarrow P) = T \Rightarrow v(D) = F$ . These values do not force  $v((L \vee C) \rightarrow (D \wedge S))$  to be anything. This will immediately yield **INVALID** since by special selection, say  $v(C) = F$ , we can always get a value  $v((L \vee C) \rightarrow (D \wedge S)) = T$ .

*Exercise 2.10, Section 2.10*

[1]. [Note: this is very important stuff. As will be shown in the next section, if a set of premises is inconsistent, then there will always be a correct logical argument that will lead to any PRESELECTED conclusion.]

(a)  $A \rightarrow (\neg(B \wedge C)), (D \vee E) \rightarrow G, G \rightarrow (\neg(H \vee I)), (\neg C) \wedge E \wedge H$ .

(1) Let  $v(A \rightarrow (\neg(B \wedge C))) = T \Rightarrow v(C) = F, v(E) = T, v(H) = T$ . (2) Let  $v(G \rightarrow (\neg(H \vee I))) = T \Rightarrow v(G) = F \Rightarrow v((D \vee E) \rightarrow G) = F$ . Hence **INCONSISTENT**.

(b)  $(A \vee B) \rightarrow (C \wedge D), (D \vee E) \rightarrow G, A \vee (\neg G)$ .

(1) Let  $v(A \vee (\neg G)) = T \Rightarrow$  case studies (1i)  $v(A) = T, v(G) = T$ , (1ii)  $v(A) = T, v(G) = F$ . (1iii)  $v(A) = F, v(G) = F$ . (2) Consider (1i). Then  $v(G) = T \Rightarrow v((D \vee E) \rightarrow G) = T$ , independent of the values



for  $D, E, C$ . (3) So, select  $v(C) = T, v(D) = T$ , then  $v((A \vee B) \rightarrow (C \wedge D)) = T$ . Thus we have found an assignment that yields T for each member of the set of premises. Hence, they are **CONSISTENT** and the formula symbols represent **ATOMS**.

(c)  $(A \rightarrow B) \wedge (C \rightarrow D), (B \rightarrow D) \wedge ((\neg C) \rightarrow A), (E \rightarrow G) \wedge (G \rightarrow (\neg D)), (\neg E) \rightarrow E$ .

(1) Let  $v((\neg E) \rightarrow E) = T \Rightarrow v(E) = T$ . (2) Let  $v((E \rightarrow G) \wedge (G \rightarrow (\neg D))) = T \Rightarrow v(G \rightarrow (\neg D)) = T \Rightarrow v(G) = T \Rightarrow v(D) = F$ . (3) Let  $v((A \rightarrow B) \wedge (C \rightarrow D)) = T \Rightarrow v(A \rightarrow B) = T, v(C \rightarrow D) = T \Rightarrow v(C) = F$ . (3) Now suppose that  $v((B \rightarrow D) \wedge ((\neg C) \rightarrow A)) = T$ . Then  $v(B \rightarrow D) = T, v((\neg C) \rightarrow A) = T \Rightarrow v(B) = F$  and from (2)  $\rightarrow v(A) = F$ . From  $v((\neg C) \rightarrow A) = T$  this yields that  $v(\neg C) = F \Rightarrow v(C) = T$ . But this contradicts the statement just before (3). Hence,  $v((B \rightarrow D) \wedge ((\neg C) \rightarrow A)) = F$  in all possible cases and the set of premises is **INCONSISTENT**.

(d)  $(A \rightarrow (B \wedge C)) \wedge (D \rightarrow (B \wedge E)), ((G \rightarrow (\neg A)) \wedge H) \rightarrow I, (H \rightarrow I) \rightarrow (G \wedge D), \neg((\neg C) \rightarrow E)$ .

(1) Let  $v((A \rightarrow (B \wedge C)) \wedge (D \rightarrow (B \wedge E))) = T \Rightarrow v(A \rightarrow (B \wedge C)) = T, v(D \rightarrow (B \wedge E)) = T$ . (2) Let  $v(\neg((\neg C) \rightarrow E)) = T \Rightarrow v((\neg C) \rightarrow E) = F \Rightarrow v(E) = F, v(C) = F$  and from (1)  $\Rightarrow v(D) = F, v(A) = F$ . Also  $\Rightarrow v(G \wedge D) = F$ . (3) Let  $v((H \rightarrow I) \rightarrow (G \wedge D)) = T \Rightarrow v(H \rightarrow I) = F \Rightarrow v(H) = T, v(I) = F$ . (4) Let  $v(((G \rightarrow (\neg A)) \wedge H) \rightarrow I) = T \Rightarrow v(((G \rightarrow (\neg A)) \wedge H)) = F \Rightarrow v(G \rightarrow (\neg A)) = F$ . But this implies that  $v(\neg A) = F \Rightarrow v(A) = T$  which contradicts the result in (2). Thus **INCONSISTENT**.

*Exercise 2.11, Section 2.11*

[1]  $\vdash (\neg(\neg A)) \rightarrow A$

- (1)  $(\neg(\neg A)) \rightarrow ((\neg(\neg(\neg A)))) \rightarrow (\neg(\neg A))$  . . . . .  $P_1$
- (2)  $((\neg(\neg(\neg A)))) \rightarrow (\neg(\neg A)) \rightarrow ((\neg A) \rightarrow (\neg(\neg(\neg A))))$  . . . . .  $P_3$
- (3)  $(\neg(\neg A)) \rightarrow ((\neg A) \rightarrow (\neg(\neg(\neg A))))$  . . . . .  $HS(1,2)$
- (4)  $((\neg A) \rightarrow (\neg(\neg(\neg A)))) \rightarrow ((\neg(\neg A)) \rightarrow A)$  . . . . .  $P_3$
- (5)  $(\neg(\neg A)) \rightarrow ((\neg(\neg A)) \rightarrow A)$  . . . . .  $HS(3,4)$
- (6)  $((\neg(\neg A)) \rightarrow ((\neg(\neg A)) \rightarrow A)) \rightarrow$   
 $((\neg(\neg A)) \rightarrow (\neg(\neg A))) \rightarrow ((\neg(\neg A)) \rightarrow A)$  . . . . .  $P_2$
- (7)  $((\neg(\neg A)) \rightarrow (\neg(\neg A))) \rightarrow ((\neg(\neg A)) \rightarrow A)$  . . . . .  $MP(5,6)$
- (8)  $((\neg(\neg A)) \rightarrow (((\neg(\neg A)) \rightarrow (\neg(\neg A))) \rightarrow (\neg(\neg A)))) \rightarrow (((\neg(\neg A)) \rightarrow$   
 $((\neg(\neg A)) \rightarrow (\neg(\neg A)))) \rightarrow ((\neg(\neg A)) \rightarrow (\neg(\neg A))))$  . . . . .  $P_2$
- (9)  $(\neg(\neg A)) \rightarrow (((\neg(\neg A)) \rightarrow (\neg(\neg A))) \rightarrow (\neg(\neg A)))$  . . . . .  $P_1$
- (10)  $((\neg(\neg A)) \rightarrow ((\neg(\neg A)) \rightarrow (\neg(\neg A)))) \rightarrow$   
 $((\neg(\neg A)) \rightarrow (\neg(\neg A)))$  . . . . .  $MP(8,9)$
- (11)  $(\neg(\neg A)) \rightarrow ((\neg(\neg A)) \rightarrow (\neg(\neg A)))$  . . . . .  $P_1$
- (12)  $(\neg(\neg A)) \rightarrow (\neg(\neg A))$  . . . . .  $MP(10,11)$
- (13)  $(\neg(\neg A)) \rightarrow A$  . . . . .  $MP(7,12)$

[2] (a)  $\vdash A \rightarrow (\neg(\neg A))$

- (1)  $((\neg(\neg(\neg A))) \rightarrow (\neg A)) \rightarrow (A \rightarrow (\neg(\neg A)))$  . . . . .  $P_3$
- (2)  $\vdash (\neg(\neg(\neg A))) \rightarrow (\neg A)$  . . . . . from [1].
- (3)  $A \rightarrow (\neg(\neg A))$  . . . . .  $MP(1,2)$

(b)  $\vdash (\neg B) \rightarrow (B \rightarrow A)$ .

- (1)  $(\neg B) \rightarrow ((\neg A) \rightarrow (\neg B))$  . . . . .  $P_1$
- (2)  $((\neg A) \rightarrow (\neg B)) \rightarrow (B \rightarrow A)$  . . . . .  $P_3$
- (3)  $(\neg B) \rightarrow (B \rightarrow A)$  . . . . .  $HS(1,2)$

*Exercise 2.12, Section 2.12*

[1]  $(\neg(\neg A)) \vdash A$ .

- (1)  $(\neg(\neg A))$  . . . . . Premise
- (2)  $(\neg(\neg A)) \rightarrow ((\neg(\neg(\neg A)))) \rightarrow (\neg(\neg A))$  . . . . .  $P_1$
- (3)  $(\neg(\neg(\neg(\neg A)))) \rightarrow (\neg(\neg A))$  . . . . .  $MP(1,2)$

- (4)  $((\neg(\neg(\neg(\neg A)))) \rightarrow (\neg(\neg A))) \rightarrow ((\neg A) \rightarrow (\neg(\neg(\neg A))))$  . . . . .  $P_3$
- (5)  $(\neg A) \rightarrow (\neg(\neg(\neg A)))$  . . . . .  $MP(3, 4)$
- (6)  $((\neg A) \rightarrow (\neg(\neg(\neg A)))) \rightarrow ((\neg(\neg A)) \rightarrow A)$  . . . . .  $P_3$
- (7)  $(\neg(\neg A)) \rightarrow A$  . . . . .  $MP(5, 6)$
- (8)  $A$  . . . . .  $MP(1, 7)$

[2] (a)  $A \rightarrow B, B \rightarrow C \vdash A \rightarrow C$ .

- (1)  $(B \rightarrow C) \rightarrow (A \rightarrow (B \rightarrow C))$  . . . . .  $P_1$
- (2)  $B \rightarrow C$  . . . . . Premise
- (3)  $A \rightarrow (B \rightarrow C)$  . . . . .  $MP(1, 2)$
- (4)  $(A \rightarrow (B \rightarrow C)) \rightarrow ((A \rightarrow B) \rightarrow (A \rightarrow C))$  . . . . .  $P_2$
- (5)  $(A \rightarrow B) \rightarrow (A \rightarrow C)$  . . . . .  $MP(3, 4)$
- (6)  $(A \rightarrow B)$  . . . . . Premise
- (7)  $A \rightarrow C$  . . . . .  $MP(5, 6)$

(b)  $(\neg A) \vdash A \rightarrow B$ .

- (1)  $\neg A$  . . . . . Premise
- (2)  $\vdash (\neg A) \rightarrow (A \rightarrow B)$  . . . . . Ex. 2.11 (2b)
- (3)  $A \rightarrow B$  . . . . .  $MP(1, 2)$

(c) Given  $\vdash (B \rightarrow A) \rightarrow ((\neg A) \rightarrow (\neg B))$ . Show that  $\neg(A \rightarrow B) \vdash B \rightarrow A$ .

- (1)  $\neg(A \rightarrow B)$  . . . . . Premise
- (2)  $\vdash (B \rightarrow A \rightarrow B) \rightarrow ((\neg(A \rightarrow B)) \rightarrow (\neg B))$  . . . . . Given
- (3)  $(B \rightarrow (A \rightarrow B))$  . . . . .  $P_1$
- (4)  $(\neg(A \rightarrow B)) \rightarrow (\neg B)$  . . . . .  $MP(2, 3)$
- (5)  $(\neg B)$  . . . . .  $MP(1, 4)$
- (6)  $(\neg B) \rightarrow (B \rightarrow A)$  . . . . . Ex. 2.11 (2b)
- (7)  $B \rightarrow A$  . . . . .  $MP(5, 6)$

*Exercise 2.13, Section 2.13*

1. Well, we use the statement that  $\vdash A \rightarrow A$  in the proof of the deduction theorem.

2.

(A) Show that  $\vdash (B \rightarrow A) \rightarrow ((\neg A) \rightarrow (\neg B))$

- (1)  $B \rightarrow A$  . . . . . Premise and D. Thm.
- (2)  $\vdash (\neg(\neg B)) \rightarrow B$  . . . . . Ex. 2.12.1 and D. Thm.
- (3)  $(\neg(\neg B)) \rightarrow A$  . . . . .  $HS(1, 2)$
- (4)  $A \rightarrow (\neg(\neg A))$  . . . . . Ex 2.11: 2a
- (5)  $(\neg(\neg B)) \rightarrow (\neg(\neg A))$  . . . . .  $HS(3, 4)$
- (6)  $((\neg(\neg B)) \rightarrow (\neg A(\neg A))) \rightarrow ((\neg A) \rightarrow (\neg B))$  . . . . .  $P_3$
- (7)  $(\neg A) \rightarrow (\neg B)$  . . . . .  $MP(5, 6)$
- (8)  $\vdash (B \rightarrow A) \rightarrow ((\neg A) \rightarrow (\neg B))$  . . . . . D. Thm.

(B) Show that  $\vdash ((A \rightarrow B) \rightarrow A) \rightarrow A$

- (1)  $(A \rightarrow B) \rightarrow A$  . . . . . Premise D. Thm
- (2)  $\vdash (\neg A) \rightarrow (A \rightarrow B)$  . . . . . D.Thm. and Ex 2.12.2b
- (3)  $(\neg A) \rightarrow A$  . . . . .  $HS(1, 2)$
- (4)  $(\neg A) \rightarrow (\neg(\neg((\neg A) \rightarrow A))) \rightarrow (\neg A)$  . . . . .  $P_1$
- (5)  $(\neg(\neg((\neg A) \rightarrow A))) \rightarrow (\neg A) \rightarrow (A \rightarrow (\neg((\neg A) \rightarrow A)))$  . . . . .  $P_3$
- (6)  $(\neg A) \rightarrow (A \rightarrow (\neg((\neg A) \rightarrow A)))$  . . . . .  $HS(4, 5)$

- (7)  $((\neg A) \rightarrow (A \rightarrow (\neg((\neg A) \rightarrow A)))) \rightarrow (((\neg A) \rightarrow A) \rightarrow ((\neg A) \rightarrow (\neg((\neg A) \rightarrow A))))$  . . . . .  $P_2$   
(8)  $((\neg A) \rightarrow A) \rightarrow ((\neg A) \rightarrow (\neg((\neg A) \rightarrow A)))$  . . . . .  $MP(6, 7)$   
(9)  $(\neg A) \rightarrow (\neg((\neg A) \rightarrow A))$  . . . . .  $MP(3, 8)$   
(10)  $((\neg A) \rightarrow (\neg((\neg A) \rightarrow A))) \rightarrow (((\neg A) \rightarrow A) \rightarrow A)$  . . . . .  $P_3$   
(11)  $((\neg A) \rightarrow A) \rightarrow A$  . . . . .  $MP(9, 10)$   
(12)  $A$  . . . . .  $MP(3, 11)$   
(13)  $\vdash ((A \rightarrow B) \rightarrow B) \rightarrow A$  . . . . . D. Thm.

[3]

$$A \rightarrow B, A \vdash B$$

- (1)  $\vdash A \rightarrow A$  . . . . . Ex. 2.11.1  
(2)  $A \rightarrow B$  . . . . . Premise  
(3)  $(A \rightarrow B) \rightarrow (A \rightarrow (A \rightarrow B))$  . . . . .  $P_1$   
(4)  $A \rightarrow (A \rightarrow B)$  . . . . .  $MP(2, 3)$   
(5)  $(A \rightarrow (A \rightarrow B)) \rightarrow ((A \rightarrow A) \rightarrow (A \rightarrow B))$  . . . . .  $P_2$   
(6)  $(A \rightarrow A) \rightarrow (A \rightarrow B)$  . . . . .  $MP(4, 5)$   
(7)  $A \rightarrow B$  . . . . .  $MP(1, 6)$

*Exercise 2.14, Section 2.14*

- [1] (a) (i)  $B, C \vdash (\neg B) \rightarrow (\neg C)$ . (ii)  $B, (\neg C) \vdash (\neg B) \rightarrow (\neg C)$ . (iii)  $(\neg B), C \vdash \neg((\neg B) \rightarrow (\neg C))$ . (iv)  $(\neg B), (\neg C) \vdash (\neg B) \rightarrow (\neg C)$ .  
(b) (i)  $B, C \vdash B \rightarrow C$ . (ii)  $B, (\neg C) \vdash \neg(B \rightarrow C)$ . (iii)  $(\neg B), C \vdash B \rightarrow C$ . (iv)  $(\neg B), (\neg C) \vdash B \rightarrow C$ .  
(c) (i)  $B, C, D \vdash B \rightarrow (C \rightarrow D)$ . (ii)  $B, C, \neg D \vdash \neg(B \rightarrow (C \rightarrow D))$ . (iii)  $B, \neg C, D \vdash B \rightarrow (C \rightarrow D)$ .  
(iv)  $B, \neg C, \neg D \vdash B \rightarrow (C \rightarrow D)$ . (v)  $\neg B, C, D \vdash B \rightarrow (C \rightarrow D)$ . (vi)  $\neg B, C, \neg D \vdash B \rightarrow (C \rightarrow D)$ .  
(vii)  $\neg B, \neg C, D \vdash B \rightarrow (C \rightarrow D)$ . (viii)  $\neg B, \neg C, \neg D \vdash B \rightarrow (C \rightarrow D)$ .  
(c) (i)  $B, C, D \vdash \neg(B \rightarrow (C \rightarrow D))$ . (ii)  $B, C, \neg D \vdash B \rightarrow (C \rightarrow D)$ . (iii)  $B, \neg C, D \vdash \neg(B \rightarrow (C \rightarrow D))$ . (iv)  $B, \neg C, \neg D \vdash \neg(B \rightarrow (C \rightarrow D))$ . (v)  $\neg B, C, D \vdash B \rightarrow (C \rightarrow D)$ . (vi)  $\neg B, C, \neg D \vdash B \rightarrow (C \rightarrow D)$ . (vii)  $\neg B, \neg C, D \vdash B \rightarrow (C \rightarrow D)$ . (viii)  $\neg B, \neg C, \neg D \vdash B \rightarrow (C \rightarrow D)$ .

*Exercise 2.16, Section 2.16*

Almost all of the interesting stuff about consequence operators involves a much deeper use of set-theory than used in these questions.

[1] Let  $\mathcal{A} \subset \mathcal{B}$ . Suppose that  $A \in C(\mathcal{A})$ . Then there is a finite  $\mathcal{F} \subset \mathcal{A}$  such that  $A \in C(\mathcal{F})$ . But  $\mathcal{F} \subset \mathcal{B}$ . Thus  $A \in C(\mathcal{B})$ . Therefore,  $C(\mathcal{A}) \subset C(\mathcal{B})$ .

[2] Let  $\mathcal{A} \subset C(\mathcal{B})$ . Then  $C(\mathcal{A}) \subset C(C(\mathcal{B})) = C(\mathcal{B})$  from [1] and our axioms.

Conversely, suppose that  $C(\mathcal{A}) \subset C(\mathcal{B})$ . Since  $\mathcal{A} \subset C(\mathcal{A})$ , then  $\mathcal{A} \subset C(\mathcal{B})$ .

[3] We know that  $\mathcal{A} \cup \mathcal{B} \subset \mathcal{A} \cup C(\mathcal{B}) \subset C(\mathcal{A}) \cup C(\mathcal{B}) \Rightarrow$  (a)  $C(\mathcal{A} \cup \mathcal{B}) \subset C(\mathcal{A} \cup C(\mathcal{B})) \subset C(C(\mathcal{A}) \cup C(\mathcal{B}))$ . Now  $C(\mathcal{A}) \subset C(\mathcal{A} \cup \mathcal{B})$ ,  $C(\mathcal{B}) \subset C(\mathcal{A} \cup \mathcal{B}) \Rightarrow C(\mathcal{A}) \cup C(\mathcal{B}) \subset C(C(\mathcal{A} \cup \mathcal{B})) = C(\mathcal{A} \cup \mathcal{B})$ . Combining this with (a) implies that  $C(\mathcal{A} \cup \mathcal{B}) \subset C(\mathcal{A} \cup C(\mathcal{B})) \subset C(C(\mathcal{A}) \cup C(\mathcal{B})) \subset C(\mathcal{A} \cup \mathcal{B})$ . Hence  $C(\mathcal{A} \cup \mathcal{B}) = C(\mathcal{A} \cup C(\mathcal{B})) = C(C(\mathcal{A}) \cup C(\mathcal{B}))$ .

Note: This is reasonable. You cannot get more deductions if you consider the premises broken up into subsets.

*Exercise 2.17, Section 2.17*

[1] (ii) If  $B \in L'$ , then either  $B \in \overline{\Gamma}$  or  $\neg B \in \overline{\Gamma}$  not both.

Proof. Assume that  $B \notin \overline{\Gamma}$ . Then  $\overline{\Gamma} \cup \{B\}$  is inconsistent. Thus there is a finite  $\{A_1, \dots, A_n\} \subset \overline{\Gamma}$  and  $A_1, \dots, A_n, B \vdash C \wedge (\neg C)$ , for some  $C \in L'$ . We know that  $C \wedge (\neg C) \models D$  for any  $D \in L'$ . Thus

$C \wedge (\neg C) \models \neg B$ . Hence,  $A_1, \dots, A_n, B \models \neg B \Rightarrow A_1, \dots, A_n \models B \rightarrow (\neg B) \models \neg B \Rightarrow A_1, \dots, A_n \models \neg B \Rightarrow A_1, \dots, A_n \vdash \neg B \Rightarrow \neg B \in \bar{\Gamma}$ . Suppose that  $B, \neg B \in \bar{\Gamma}$ . Then this contradicts Theorem 2.17.1 (e).

(iii) If  $B \in \bar{\Gamma}$ , then  $A \rightarrow B \in \bar{\Gamma}$  for each  $A \in L'$ .

Proof. Let  $B \in \bar{\Gamma}$ . The  $\bar{\Gamma} \vdash B$ . Thus there is a finite  $\mathcal{F} \subset \bar{\Gamma}$  such that  $\mathcal{F} \vdash B$ . Hence  $\mathcal{F} \models B$ . But  $B \models A \rightarrow B$  for any  $A \in L'$ . Hence  $\mathcal{F} \models A \rightarrow B \Rightarrow \mathcal{F} \vdash A \rightarrow B \Rightarrow \bar{\Gamma} \vdash A \rightarrow B \Rightarrow A \rightarrow B \in \bar{\Gamma}$ .

(iv) If  $A \notin \bar{\Gamma}$ , then  $A \rightarrow B \in \bar{\Gamma}$  for each  $B \in L'$ .

Proof. If  $A \notin \bar{\Gamma}$ , then  $\neg A \in \bar{\Gamma}$  from (ii). But for any  $B \in L'$ ,  $\neg A \models A \rightarrow B \Rightarrow \neg A \vdash A \rightarrow B$  and since  $\neg A \in \bar{\Gamma}$ ,  $\bar{\Gamma} \vdash A \rightarrow B$ . Hence  $A \rightarrow B \in \bar{\Gamma}$ .

(v) If  $A \in \bar{\Gamma}$  and  $B \notin \bar{\Gamma}$ , then  $A \rightarrow B \notin \bar{\Gamma}$ .

Proof. Let  $A \in \bar{\Gamma}$ ,  $B \notin \bar{\Gamma}$ . Suppose that  $A \rightarrow B \in \bar{\Gamma}$ . Then  $\bar{\Gamma} \vdash A \rightarrow B$ . Since  $\bar{\Gamma} \vdash A$ , by one MP step  $\bar{\Gamma} \vdash B \Rightarrow B \in \bar{\Gamma}$ ; a contradiction. The result follows.

[2] (a)  $\models A$  iff  $\{\neg A\}$  is not satisfiable.

Proof. Let  $\models A$ . Then for each  $\underline{a}$ ,  $v(A, \underline{a}) = T$ . Hence for each  $\underline{a}$ ,  $v(\neg A, \underline{a}) = F$ . Hence  $\{\neg A\}$  is not satisfiable.

Conversely, let  $\{\neg A\}$  not be satisfiable. Then for each  $\underline{a}$ ,  $v(\neg A, \underline{a}) = F$ . This for each  $\underline{a}$ ,  $v(A, \underline{a}) = T$ . Thus  $A$  is satisfiable.

(b)  $\{A\}$  is consistent iff  $\not\vdash \neg A$ .

Proof. Let  $\{A\}$  be consistent and  $\vdash \neg A$ . Hence  $\models \neg A$ . Hence for each  $\underline{a}$ ,  $v(\neg A, \underline{a}) = T \Rightarrow v(A, \underline{a}) = F$ . Hence  $A \models B \wedge (\neg B)$  for some  $B$ . Thus  $A \vdash B \wedge (\neg B)$ . Thus  $\{A\}$  is inconsistent: a contradiction.

Conversely, let  $\not\vdash \neg A$ . Then  $\not\models \neg A$ . Hence there is some  $\underline{a}$  such that  $v(\neg A, \underline{a}) = F \Rightarrow v(A, \underline{a}) = T \Rightarrow A \not\models B \wedge (\neg B)$  for any  $B$ .  $A \not\vdash B \wedge (\neg B)$  for any  $B$  implies that  $\{A\}$  is consistent.

(c) The Completeness Theorem is equivalent to the statement that every consistent formula is satisfiable.

Proof. Assume Completeness Theorem. Now let  $\{A\}$  be consistent. Then from (b)  $\not\vdash \neg A$ . Hence from Completeness contrapositive, we have that  $\not\models \neg A$ . Thus there is some  $\underline{a}$  such that  $v(\neg A, \underline{a}) = F$ . Hence  $v(A, \underline{a}) = T$ . Thus  $\{A\}$  is satisfiable.

Conversely, assume that all consistent formula are satisfiable. [Note we cannot use the Completeness Theorem since this is what we want to establish.] Let  $\models A$ . Then clearly  $\neg A$  is not satisfiable. Hence, from the contrapositive of our assumption,  $\{\neg A\}$  is inconsistent. Thus  $\neg A \vdash$  anything. Consequently,  $\neg A \vdash A \Rightarrow$  (a)  $\vdash (\neg A) \rightarrow A$ . But  $\vdash (A \rightarrow A) \rightarrow (((\neg A) \rightarrow A) \rightarrow A)$ , by example 2.15.4. But  $\vdash A \rightarrow A$ . Hence by one MP step we have that  $\vdash ((\neg A) \rightarrow A) \rightarrow A$ . Adjoining this formal proof to (a), and we get  $\vdash A$ . This is but the Completeness Theorem.

[3] (a) Let  $\underline{a}$  be any assignment to  $A$ . Then since  $\models A \rightarrow A$ . Now this could be established by formal induction, but more simply, note that if  $\emptyset \neq \mathcal{F} \subset \Gamma$ , then one member of  $\mathcal{F}$  contains that largest number of  $A$ s, say  $n \geq 2$  and the smallest sized subformula is  $A \rightarrow A$  which has truth value  $T$ . All other formula, if any, have  $A \rightarrow$  to the left etc. and, hence, have value  $T$ . It appears that  $\Gamma$  is consistent.

(b)  $\{A_3\}$  is finite inconsistent subset of  $\Gamma$ . Hence  $\Gamma$  is inconsistent.

(c)  $\{A_1, A_2\}$  is a finite inconsistent subset of  $\Gamma$ . Hence,  $\Gamma$  is inconsistent.

### Exercise 3.1, Section 3.1

[1] (a)  $A \in Pd$ , (b)  $A \notin Pd$ , [Note the  $\exists c$ .] (c)  $A \notin Pd$ , [Note the third (. (d)  $A \notin Pd$ , [Note the symbols  $\forall y$ .] (e)  $A \notin Pd$ , [Note the missing last two parentheses.]

[2] (a) size (A) = 3, (b) size (A) = 4 (c) size (A) = 4, (d) size (A) = 4.

[3] Please note the way I've translated these statements into first-order predicate form is not a unique translation. It is, however, in a mathematically standard form. Also note that from this moment on, we will simply any formula that has a sequence of more than one  $\wedge$ s or  $\vee$ s by not putting parentheses about the inner subformula. Indeed, the way we write or language tends not to include pauses between such combinations. [They are all equivalent no matter where we put the parentheses.] Finally notice that when we use the operators as abbreviations for the predicates we include ( and ) only to avoid confusion. If you make a complete substitution , it will look like this  $(x + 1 = y) \equiv R(x, 1, y)$ .

- (a)  $\forall x((P(x) \wedge (x = 0)) \rightarrow (\exists y(Q(y, x) \wedge (y > x))))$   
 (b)  $\forall x(R(x) \rightarrow (\exists y(R(x) \wedge (y > x))))$   
 (c)  $\forall x(\exists y(\forall z((R(x) \wedge R(y) \wedge R(z) \wedge (z + 1 < y)) \rightarrow (x + 2 < 4))))$   
 (d)  $\forall x((W(x) \wedge L(x)) \rightarrow (\exists y(J(y) \wedge A(x, y))))$   
 (e)  $\exists x(L(x) \wedge S(x) \wedge A(x, j))$   
 (f)  $\forall x(\forall y(\forall z(((P(x) \wedge P(y) \wedge P(z) \wedge R(x, z) \wedge R(y, z)) \rightarrow R(x, y))))$   
 (g)  $\forall x(B(x) \rightarrow M(x))$   
 (h)  $\forall x(P(x) \rightarrow (C(x) \wedge U(x)))$   
 (i)  $\forall x(\forall y(\forall z((x = y) \wedge (y = z) \wedge (x = z) \wedge (x > 0) \wedge (y > 0) \wedge (z > 0) \wedge (x + y + z > 3) \wedge (x + y + z < 9)) \rightarrow ((1 < x < 3) \wedge (1 < y < 3) \wedge (1 < z < 3))))$   
 (j)  $\forall x(\forall y((P(x) \wedge P(y) \wedge B(x, y)) \leftrightarrow (M(x) \wedge M(y) \wedge (\neg(x = y)) \wedge Q(x, y))))$

[4] [Note: In what follows, you do not need to inquire whether or not the statement holds in order to translate into symbolic form.]

(a) Seven is a prime number and seven is an odd number.

(b) (Two different ways). For each number, if 2 divides the number, then the number is even. [Note: A metalanguage variable symbol can also be used. For each X, if 2 divides X, then X is even. You can also write it more concisely as “For each X, if X is a number and 2 divides X, then X is even.” This is the very important “bounded form.” The X is restricted to a particular set.]

(c) Using the metasymbol method, we have “There exists an X such that X is an even number and X is a prime number, and there does not exist an X such that X is an even number and X is a prime, and there exists some Y such that Y is not equal to X and Y is an even number and Y is a prime number.

(d) For each X; if X is an even number, then for each Y, if X divides Y, then Y is an even number.

(e) For each X, if X is an odd number, then there exists a Y such that if Y is a prime number, then Y divides X.

### Exercise 3.2, Section 3.2

[1] (a) (1) scope =  $\exists xQ(x, z)$ . (2) scope =  $Q(x, z)$ . (3) scope =  $Q(y, z)$ .

(b) (1) scope =  $\forall y(P(c) \wedge Q(y))$ . (2) scope =  $P(c) \wedge Q(y)$ . (3) scope =  $R(x)$ .

(c) (1) scope =  $(Q(y, z) \rightarrow (\forall xR(x)))$ . (2) scope =  $R(x)$ .

(d) (1) scope =  $(P(z) \wedge (\exists xQ(x, z))) \rightarrow (\forall z(Q(c) \vee P(z)))$ . (2) scope =  $Q(x, z)$ . (3) scope =  $(Q(c) \vee P(z))$ .

[2]

(a)  $\forall z_3(\exists y_2(P(z_3, y_2) \wedge (\forall z_1Q(z_1, x)) \rightarrow M(z_3)))$ .

(b)  $\forall x_3(\exists y_2(P(x_3, y_2) \wedge (\forall y_1Q(y_1, x_3)) \rightarrow M(x_3)))$ .

(c)  $\forall z_3(\exists x_2(P(z_3, x_2) \wedge (\forall z_1Q(z_1, y)) \rightarrow M(z_3)))$ .

(d)  $\forall y_3(\exists z_2(P(y_3, z_2) \wedge (\forall z_1Q(z_1, x)) \rightarrow M(y_3)))$ .

(e)  $\forall y_3(\exists z_2(P(z_2, y_3) \wedge (\forall z_1Q(z_1, x)) \rightarrow M(y_3)))$ .

(f)  $\exists x_3(\forall z_2(P(x_3, z_2) \vee (\forall u_1M(u_1, y, x_3))))$ .

(g)  $\exists y_3(\forall x_2(P(z, x_2) \vee (\forall x_1M(x_1, u, y_3))))$ .

(h)  $\exists y_3(\forall x_2(P(y_3, x_2) \vee (\forall x_1M(x_1, y_3, z))))$ .

(i)  $\exists z_3(\forall x_2(P(z_3, x_2) \vee (\forall x_1M(x_1, y, z_3))))$ .

(j)  $\exists x_3(\forall x_2(P(z, x_2) \vee (\forall z_1M(x_2, y, z_1))))$ .

[3] (a)  $\cong (d)$ ; (f)  $\cong (i)$ .

[4] (a) Free,  $x, y, z$ ; Bound  $x, z$ .

- (b) Free,  $z$ : Bound  $x, z$ .
- (c) Free,  $x, y$ ; Bound  $x$ .
- (d) Free,  $z$ ; Bound  $x, y, z$ .
- (e) Free,  $x$ ; Bound  $x, y$ .
- (f) Free, none; Bound  $x, y$ .

[5] (a) They are (b), (d). (b) It is (b). (c) It is (f)

### Exercise 3.3, Section 3.3

[1] (a)  $S_a^x (\exists xP(x) \rightarrow R(x, y)) = (\exists xP(x)) \rightarrow R(a, y)$ . (b)  $S_x^y (\exists yR(x, y) \leftrightarrow (\forall xR(x, y))) = (\exists yR(x, y)) \leftrightarrow (\forall xR(x, y))$ . (c)  $S_a^y (\forall xP(y, x) \wedge (\exists yR(x, y))) = (\forall xP(a, x)) \wedge (\exists yR(x, y))$ , (d)  $S_a^x S_b^x (\exists xP(x) \rightarrow R(x, y)) = (\exists xP(x)) \rightarrow R(b, y)$ . (e)  $S_a^x S_x^y (\exists yR(x, y) \leftrightarrow (\forall xR(x, y))) = (\exists yR(x, y)) \leftrightarrow (\forall xR(x, x))$ . (f)  $S_a^x S_b^y (\forall zP(y, x) \wedge (\exists yR(x, y))) = (\forall zP(b, a)) \wedge (\exists yR(a, y))$

[2] (a) always true. (b) NOT true. Consider the example  $\forall yP(x, y)$ . (c) Always true. An argument is that, for the left hand side, we first substitute for all free occurrences of  $z$ , if any, a  $w$ . Whether or not the result gives no free occurrences of  $w$  or not will not affect the substitution of  $x$  for the free occurrences of  $y$  since these are all distinct variables. The same argument goes for the right hand side. (d) Always true. These are the “do nothing” operators.

[3] (I have corrected the typo. by inserting the missing ( and ) in each formula.)

(a)  $A = (\forall x(P(c) \vee Q(x, x))) \rightarrow (P(c) \vee \forall xQ(x, x))$ . We need to determine what the value of  $(\forall x(P(c) \vee Q(x, x)))$  is for this structure. Thus we need to determine the “value” of the statement  $P'(a')$  or  $Q'(a', a')$  and  $P'(a')$  or  $Q'(b', b')$ . Since  $a' \in P'$  then  $\mathcal{M} \models (\forall x(P(c) \vee Q(x, x)))$ . For the statement  $(P(c) \vee \forall xQ(x, x))$ , the same fact that  $a' \in P'$  yields that  $\mathcal{M} \models (P(c) \vee \forall xQ(x, x))$ . Hence  $\mathcal{M} \models A$ .

(b)  $A = (\forall x(P(c) \vee Q(x, x))) \rightarrow (P(c) \wedge \forall xQ(x, x))$ . We repeat the above for  $(\forall x(P(c) \vee Q(x, x)))$  and get  $\mathcal{M} \models (\forall x(P(c) \vee Q(x, x)))$ . We now check  $(P(c) \wedge \forall xQ(x, x))$ . We know that  $\mathcal{M} \models P(c)$ . But  $(b', b') \notin Q'$ . Hence  $\mathcal{M} \not\models (P(c) \wedge \forall xQ(x, x)) \Rightarrow \mathcal{M} \not\models A$ .

(c)  $A = (\forall x(P(c) \vee Q(x, x))) \rightarrow (P(c) \wedge \exists xQ(x, x))$ . Again we know that  $\mathcal{M} \models (\forall x(P(c) \vee Q(x, x)))$ . Also  $\mathcal{M} \models P(c)$ . Further,  $(a', a') \in Q'$ . Thus  $\mathcal{M} \models \exists xQ(x, x) \Rightarrow \mathcal{M} \models (P(c) \wedge \exists xQ(x, x)) \Rightarrow \mathcal{M} \models A$ .

(d)  $A = (\forall x(P(c) \wedge Q(x, x))) \leftrightarrow (P(c) \wedge \forall xQ(x, x))$ . First, we know that  $\mathcal{M} \models P(c)$ . But  $(b', b') \notin Q'$ . Hence, know that under our interpretation the mathematical statement corresponding to  $(\forall x(P(c) \wedge Q(x, x)))$  is false. Thus  $\mathcal{M} \not\models (\forall x(P(c) \wedge Q(x, x)))$ . We now check  $(P(c) \wedge \forall xQ(x, x))$ . Again since  $(b', b') \notin Q'$  the mathematical statement is false. But then this implies that  $\mathcal{M} \models A$ .

(e)  $A = (\forall x(P(c) \wedge Q(c, x))) \leftrightarrow (P(c) \wedge \forall xQ(x, x))$ . Since  $(a', a')$ ,  $(a', b') \in Q'$  and  $a' \in P'$  the mathematical statement  $(\forall x(P(c) \wedge Q(c, x)))$  holds for this structure. Thus  $\mathcal{M} \models (\forall x(P(c) \wedge Q(c, x)))$ . But as shown in (d)  $\mathcal{M} \not\models (P(c) \wedge \forall xQ(x, x))$ . Hence,  $\mathcal{M} \not\models A$ .

### Exercise 3.4, Section 3.4

[1] (a) Note that it was not necessary to discuss special structures in our definition for validity unless we wanted to find a countermodel. But in this case we need to also look at certain special structures. In particular, the case for this problem that  $P' = \emptyset$ . But in this case, for any structure  $\mathcal{M}_I \not\models (\forall x(\exists yP(x, y)))$ . Thus for this possibility,  $\mathcal{M}_I \models (\forall x(\exists yP(x, y))) \rightarrow (\exists y(\forall xP(x, y)))$ .

Now letting  $D = \{a'\}$ , then the only other possibility is that  $P' = \{(a', a')\}$ . Mathematically, it is true that there exists an  $a' \in D$ , for all  $a' \in D$  we have that  $(a', a') \in P'$ . Hence, in this case,  $\mathcal{M}_I \models \exists y(\forall xP(x, y))$ . Consequently,  $\mathcal{M}_I \models (\forall x(\exists yP(x, y))) \rightarrow (\exists y(\forall xP(x, y)))$ .

(b) Consider  $D = \{a', b'\}$ ,  $P' = \{(a', a'), (b', b')\}$ . Then since  $(a', a'), (b', b') \in P'$ , it follows that  $\mathcal{M}_I \models (\forall x(\exists yP(x, y)))$ . However, since  $(b', a'), (b', b') \notin P'$  the mathematical statement “there exists some  $d' \in D$  such that  $(a', d'), (b', d')$ ” does not hold. [Notice that the difference is that in the first case the second coordinate can be any member of  $D$  while in the second case it must be a fixed member of  $D$ . Therefore,  $\mathcal{M}_I \not\models (\forall x(\exists yP(x, y))) \rightarrow (\exists y(\forall xP(x, y)))$  and the formula is not 2-valid. [Hence, not valid in general]

[2]. In what follows I will make the substitution and see what happens in each case. (a)  $A = \forall w(P(x) \vee (\forall xP(x, y)) \vee P(w, x)); \lambda = y \Rightarrow \forall w(P(y) \vee (\forall xP(x, y)) \vee P(w, y))$ . Since  $y \neq w$  then  $y$  is free for  $x$  in  $A$ .

(b)  $A = \forall w(P(x) \vee (\forall xP(x, y)) \vee P(w, x))$ ;  $\lambda = w \Rightarrow \forall w(P(x) \vee (\forall xP(x, y)) \vee P(w, \underline{w}))$ . Now the variable has gone from a free occurrence in the underlined part to a bound occurrence. Hence  $w$  is not free for  $x$  in this  $A$ .

(c)  $A = (\forall x(P(x) \vee (\forall yP(x, y)))) \vee P(y, x)$ ;  $\lambda = x$ . Yes, any variable is always free for itself.

(d)  $A = (\forall x(P(x) \vee (\forall yP(x, y)))) \vee P(y, x)$ ;  $\lambda = y \Rightarrow (\forall x(P(x) \vee (\forall yP(x, y)))) \vee P(y, \underline{y})$ . Since the only place that  $x$  is free in this formula is in the underlined position, the result of substitution still gives a free occurrence, this time of  $y$ . Hence, in this case,  $y$  is free for  $x$  in  $A$ .

(e)  $A = (\forall x(\exists yP(x, y)) \rightarrow (\exists yP(y, y)))$ ;  $\lambda = y$ . Since there are no free occurrences of  $x$  in this formula, then any variable is free for  $x$  in this formula.

(f)  $A = (\exists zP(x, z)) \rightarrow (\exists zP(y, z))$ ;  $\lambda = z \Rightarrow (\exists zP(\underline{z}, z)) \rightarrow (\exists zP(y, z))$ . Since at the only position that  $x$  was free, the substitution now makes this position a bound occurrence, then  $z$  is not free for  $x$  in  $A$ .

[3] See the above formula where I have made the substitutions in all cases.

[4] Assume that  $C$  does not have  $x$  as a free variable and that  $B$  may contain  $x$  as a free variable. Further, it's assumed that there are no other possible free variables. [This comes from, our use of the special process (i).]  $\exists x(C \wedge B)$  is a sentence. Let  $\mathcal{M}_I$  be an arbitrary structure. Assume that  $\mathcal{M}_I \models \exists x(C \wedge B)$ . Then there exists some  $d' \in D$ ,  $\mathcal{M}_I \models S_d^x(C \wedge B) = C \wedge S_d^x B$ . Hence,  $\mathcal{M}_I \models C$  and for some  $d' \in D$ ,  $\mathcal{M}_I \models S_d^x B$ . Hence,  $\mathcal{M}_I \models (C \wedge (\exists xB))$ . Then in like manner, since  $x$  is not free in  $C$ ,  $\mathcal{M}_I \models (C \wedge (\exists xB)) \Rightarrow \mathcal{M}_I \models \forall x(C \wedge B)$ . [Note I have just copied the metaproof of (vii) and made appropriate changes.]

[5] (a)  $Q(x) \rightarrow (\forall xP(x))$ . Of course, we first take the universal closure. This gives the sentence  $\forall(Q(x) \rightarrow (\forall xP(x)))$ . I have an intuitive feeling, since  $Q$  can be anything, that this is invalid. So, we must display a countermodel. To establish that  $\mathcal{M}_I \models Q(x) \rightarrow (\forall xP(x))$ . We consider  $S_d^x(Q(x) \rightarrow (\forall xP(x)))$ . Since  $x$  is not free in  $\forall xP(x)$ , the valuation of  $S_d^x(Q(x) \rightarrow (\forall xP(x)))$  is the same as the valuation for  $(\forall xQ(x)) \rightarrow (\forall xP(x))$ . Now this makes sense. But this is not even 1-valid. For take  $D = \{a'\}$ ,  $Q' = D$ ,  $P' = \emptyset$ . Then  $\mathcal{M}_I \models (\forall xQ(x))$  but  $\mathcal{M}_I \not\models (\forall xP(x))$ . Hence  $\mathcal{M}_I \not\models \forall(Q(x) \rightarrow (\forall xP(x)))$ . Thus the formula is INVALID.

(b)  $(\exists xP(x)) \rightarrow P(x)$ . One again you consider the universal closure and we consider the formula  $(\exists xP(x)) \rightarrow (\forall xP(x))$ . Thus also does not seem "logical" in general. [Note that taking an empty relation will not do it.] But take  $D = \{a', b'\}$ ,  $P' = \{a'\}$ . Now it follows that  $\mathcal{M}_I \models (\exists xP(x))$ . Since  $b' \notin P'$ , then  $\mathcal{M}_I \not\models (\forall xP(x))$ . Thus INVALID.

(c)  $(\forall x(P(x) \wedge Q(x))) \rightarrow ((\forall xP(x)) \wedge (\forall xQ(x)))$ . We don't need to do much work here. Simply consider Theorem 3.4.9 part (vi). Then let  $A = P(x)$ ,  $B = Q(x)$ . Since that formula is valid, then if  $\mathcal{M}_I$  is any structure for (c), and  $\mathcal{M}_I \models (\forall x(P(x) \wedge Q(x)))$ , then  $\mathcal{M}_I \models ((\forall xP(x)) \wedge (\forall xQ(x)))$ . Thus formula is VALID.

(d)  $(\exists x(\exists yP(x, y))) \rightarrow (\exists xP(x, x))$ . This seems to be invalid since mathematically in the for  $\mathcal{M}_I \models (\exists x(\exists yP(x, y)))$  we do not need  $x = y$  in the mathematical sense. This is that you can have some  $a'$  and some  $b' \neq a'$ , which satisfy a binary relation but  $(a', a')$  and  $(b', b')$  do not and this is exactly how we construct a countermodel. Let  $D = \{a', b'\}$ ,  $P' = \{(a', b')\}$ . Then  $\mathcal{M}_I \models (\exists x(\exists yP(x, y)))$ , but  $\mathcal{M}_I \not\models (\exists xP(x, x))$ . Hence INVALID

(e)  $(\exists xQ(x)) \rightarrow (\forall xQ(x))$ . This also seems to be invalid. Well, take  $D = \{a', b'\}$ ,  $Q' = \{a'\}$ . Then clearly,  $\mathcal{M}_I \models (\exists xQ(x))$ . But since  $b' \notin Q'$ , then  $\mathcal{M}_I \not\models (\forall xQ(x))$ .

[6] [This is a very important process.]

(a)  $(\neg(\exists xP(x))) \vee (\forall xQ(x)) \equiv (\neg(\exists xP(x))) \vee (\forall yQ(y)) \equiv (\forall x(\neg P(x))) \vee (\forall yQ(y)) \equiv \forall y(Q(y) \vee (\forall x(\neg P(x)))) \equiv \forall y(\forall x(Q(y) \vee P(x)))$ .

(b)  $((\neg(\exists xP(x))) \vee (\forall xQ(x))) \wedge (S(c) \rightarrow (\forall xR(x))) \equiv ((\forall y(\neg P(y))) \vee (\forall xQ(x))) \wedge (S(c) \rightarrow (\forall xR(x))) \equiv (\forall y(\forall x(\neg P(y) \vee Q(x)))) \wedge (S(c) \rightarrow (\forall xR(x))) \equiv (\forall y(\forall x(\neg P(y) \vee Q(x)))) \wedge (S(c) \rightarrow (\forall zR(z))) \equiv (\forall y(\forall x(\neg P(y) \vee Q(x)))) \wedge (\forall z(S(c) \rightarrow R(z))) \equiv \forall y(\forall x(\forall z((\neg P(y) \vee Q(x)) \wedge (S(c) \rightarrow R(z))))$ .

(c)  $\neg(((\neg(\exists xP(x))) \vee (\forall xQ(x))) \wedge (\forall xR(x))) \equiv \neg(\forall y(\forall x(\forall z((\neg P(y) \vee Q(y)) \wedge R(z)))) = \exists y(\exists x(\exists z(P(x) \wedge (\neg Q(y)) \vee (\neg R(z))))$ .

### Exercise 3.4, Section 3.5

As suggested, I might try the deduction theorem for valid consequence determinations. [1] (a) Consider  $A_1 = \forall x(Q(x) \rightarrow R(x))$ ,  $A_2 = \exists xQ(x)$ ,  $B = \exists xR(x)$ .

Suppose that  $\mathcal{M}_I$  is ANY structure, defined for  $A_1$ ,  $A_2$ ,  $B$  such that  $\mathcal{M}_I \not\models \exists xR(x)$ . Hence, for each  $c' \in D$ ,  $c' \notin R'$ . Thus, we have that  $R'$  is the empty set. Hence, under the hypothesis assume that  $\mathcal{M}_I \models \forall x(Q(x) \rightarrow R(x))$ . This means that for each  $c' \in D$ ,  $\mathcal{M}_I \models Q(c') \rightarrow R(c')$ . However, we know that  $\mathcal{M}_I \not\models R(c')$  for each  $c' \in D$ . Hence for each  $c' \in D$ ,  $\mathcal{M}_I \not\models \exists xQ(x)$ . Therefore,  $\mathcal{M}_I \not\models Q(x)$ . This implies that it is a VALID CONSEQUENCE.

Not using the deduction theorem, proceed as follows: suppose that  $\mathcal{M}_I$  is a structure defined for  $A_1$ ,  $A_2$ ,  $B$ . Let  $\mathcal{M}_I \models A_1$ ,  $\mathcal{M}_I \models A_2$ . Then for every  $c' \in D$ ,  $\mathcal{M}_I \models Q(c') \rightarrow R(c')$ . Now since  $\mathcal{M}_I \models A_2$ , then there is some  $c'_1 \in D$  such that  $\mathcal{M}_I \models Q(c'_1)$  (i.e.  $Q'$  is not empty). Since  $\mathcal{M}_I \models Q(c'_1) \rightarrow R(c'_1)$ , then for this  $c'_1$  we have that  $\mathcal{M}_I \models R(c'_1)$ . Hence  $\mathcal{M}_I \models B$ . Thus it is a VALID CONSEQUENCE.

(b)  $A_1 = \forall x(Q(x) \rightarrow R(x))$ ,  $A_2 = \exists x(Q(x) \wedge Z(x)) \models B = \exists x(R(x) \wedge Z(x))$ . (Without deduction theorem.) Suppose that there is any structure  $\mathcal{M}_I$  defined for  $A_1$ ,  $A_2$ ,  $B$  and  $\mathcal{M}_I \models A_1$ ,  $\mathcal{M}_I \models A_2$ . Hence, for each  $c' \in D$ ,  $\mathcal{M}_I \models Q(c') \rightarrow R(c')$  and there exists some  $c'_1 \in D$  such that  $\mathcal{M}_I \models Q(c'_1) \wedge Z(c'_1)$ . Thus  $c'_1 \in Q'$  and  $c'_1 \in Z'$ . Since  $c'_1 \in Q'$ , then  $c'_1 \in R'$ . Thus using this  $c'_1$  we have that  $\mathcal{M}_I \models \exists x(R(x) \wedge Z(x))$ . Hence  $\mathcal{M}_I \models B$  implies that we have a VALID CONSEQUENCE.

(c)  $A_1 = \forall x(P(x) \rightarrow (\neg Q(x)))$ ,  $A_2 = \exists x(Q(x) \wedge R(x)) \models B = \exists x(R(x) \wedge (\neg Q(x)))$ .

We have a feeling that this might be invalid, so we need to construct a countermodel Consider a one element domain  $D = \{a'\}$ . Let  $P' = \emptyset$ ,  $Q' = R' = D$ . Let  $\mathcal{M}_I = \langle D, P', Q', R' \rangle$ . Then  $\mathcal{M}_I \models A_1$ , and  $\mathcal{M}_I \models A_2$ . But, since there is no member of  $c' \in D$  such that  $\mathcal{M}_I \models R(c')$  and  $\mathcal{M}_I \models \neg Q(x)$  (i.e. there is no member of  $D$  that is a member of  $D$  and not a member of  $D$ ), it follows that  $\mathcal{M}_I \not\models B$ . Hence, argument is INVALID.

(d)  $A_1 = \forall x(P(x) \rightarrow Q(x))$ ,  $A_2 = \exists x(Q(x) \wedge R(x)) \models B = \exists x(R(x) \wedge (\neg Q(x)))$ .

Take the same structure as defined in (c). The fact that  $\mathcal{M}_I \models A_1$  is not dependent upon the definition of  $Q'$ . Hence, the argument is still INVALID.

Exercise 3.6, Section 3.6

(A)  $\forall x(A \rightarrow B)$ ,  $\forall x(\neg B) \vdash \forall x(\neg A)$ .

- (1)  $\forall x(A \rightarrow B)$  . . . . . Premise
- (2)  $\forall x(\neg B)$  . . . . . Premise
- (3)  $\forall x(A \rightarrow B) \rightarrow (A \rightarrow B)$  . . . . .  $P_5$
- (4)  $A \rightarrow B$  . . . . . MP(1,3)
- (5)  $(A \rightarrow B) \rightarrow ((\neg B) \rightarrow (\neg A))$  . . . . . Exer. 2.13, 2A.
- (6)  $(\neg B) \rightarrow (\neg A)$  . . . . . MP(4,5)
- (7)  $(\forall x(\neg B)) \rightarrow (\neg B)$  . . . . .  $P_5$
- (8)  $\neg B$  . . . . . MP(2,7)
- (9)  $\neg A$  . . . . . MP(6,8)
- (10)  $\forall x(\neg A)$  . . . . . G(9)

(B)  $\forall x(\forall yA) \vdash \forall y(\forall xA)$

- (1)  $\forall x(\forall yA)$  . . . . . Premise
- (2)  $(\forall x(\forall yA)) \rightarrow \forall yA$  . . . . .  $P_5$
- (3)  $\forall yA$  . . . . . MP(1,2)
- (4)  $(\forall yA) \rightarrow A$  . . . . .  $P_5$
- (5)  $A$  . . . . . MP(3,4)
- (6)  $\forall xA$  . . . . . G(5)
- (7)  $\forall y(\forall xA)$  . . . . . G(6)

(C)  $A$ ,  $(\forall xA) \rightarrow C \vdash \forall xC$



- (1)  $A$  . . . . . Premise
- (2)  $\forall xA$  . . . . . G(1)
- (3)  $(\forall xA) \rightarrow C$  . . . . . Premise
- (4)  $C$  . . . . . MP(2,3)
- (5)  $\forall xC$  . . . . . G(4)

(D)  $\forall x(A \rightarrow B), \forall xA \vdash \forall xB$

- (1)  $\forall x(A \rightarrow B)$  . . . . . Premise
- (2)  $\forall xA$  . . . . . Premise
- (3)  $(\forall x(A \rightarrow B)) \rightarrow (A \rightarrow B)$  . . . . .  $P_5$
- (4)  $A \rightarrow B$  . . . . . MP(1,3)
- (5)  $(\forall xA) \rightarrow A$  . . . . .  $P_5$
- (6)  $A$  . . . . . MP(2,5)
- (7)  $B$  . . . . . MP(4,6)
- (8)  $\forall xB$  . . . . . G(7)

*Exercise 3.7, Section 3.7*

1. Using the special process, it may be assumed that  $A$  has no free variables and the  $B$  has at most one free variable  $x$ . We show that  $\models (\forall x(A \rightarrow B)) \rightarrow (A \rightarrow (\forall xB))$ .

Proof. Let  $\mathcal{M}_I$  be any structure defined for  $A, B$  and we only need to suppose that  $\mathcal{M}_I \not\models A \rightarrow (\forall xB)$ .

Consider the case that  $x$  is not free in  $B$ . Then  $B$  is a sentence. Now in this case  $\mathcal{M}_I \models \forall x(A \rightarrow B)$  iff  $\mathcal{M}_I \models A \rightarrow B$ . Since  $\mathcal{M}_I \not\models B$  and  $\mathcal{M}_I \models A$ , it follows that  $\mathcal{M}_I \not\models A \rightarrow B$ . Hence  $\mathcal{M}_I \models (A \rightarrow B) \rightarrow (A \rightarrow B)$ .

Now assume that  $x$  is free in  $B$ . Then we know that for  $\mathcal{M}_I \models \forall x(A \rightarrow B)$  then  $\mathcal{M}_I \models A \rightarrow S_d^x B$  for each  $c' \in D$ . But, we have from our assumption that  $\mathcal{M}_I \models A$  and there is some  $c' \in D$  such that  $\mathcal{M}_I \not\models S_d^x B$ . Hence  $\mathcal{M}_I \not\models S_d^x B$  for each  $c' \in D$ . Thus  $\mathcal{M}_I \not\models \forall x(A \rightarrow B)$ . Therefore,  $\mathcal{M}_I \models (\forall x(A \rightarrow B)) \rightarrow (A \rightarrow B)$ .

*Exercise 3.8, Section 3.8*

1. Modify the argument given in example 3.8.1 as follows: let  $L(x, y)$  correspond to the natural number binary relation of “less than” (i.e.  $<$ ). Give an argument that shows that there is a structure  $^*\mathcal{M}_I$  that behaves like the natural numbers but in which there exists a member  $b'$  that is “greater than” any of the original natural numbers.

As in that example, let  $\Gamma$  be the theory of natural numbers, described by a given  $Pd$ , and each member of  $C$  denotes a member of the domain  $D$  for a model  $\mathcal{M}_I$  for  $\Gamma$ , where  $\mathcal{M}_I \models$  models all of the theory definable predicts as well. Again we let  $b$  be a constant not in the original  $C$  and adjoin this the  $C$ . Consider the set of sentences  $\Phi = \{L(c, b) \mid c \in C\}$ . Now consider the set of sentences  $\Gamma \cup \Phi$  and let  $A$  be a finite subset of  $\Gamma \cup \Phi$ . If  $\{a_1, \dots, a_n\} \subset A$  and  $\{a_1, \dots, a_n\} \subset \Gamma$ , then  $\mathcal{M}_I \models$  is a model  $\{a_1, \dots, a_n\}$ . Suppose that  $\{a_{n+1}, \dots, a_m\}$  are the remaining members of  $A$  that are not in  $\Gamma$ . Now we investigate the actual members of  $\Phi$ . We know from the theory of natural numbers that for any finite set of natural numbers there is a natural number  $b'$  greater than any member of that set. Now each member of  $\{a_{n+1}, \dots, a_m\}$  is but the sentence  $L(c, b)$  where  $c \in C$  and  $b \notin C$ . Thus there are at most finitely many different  $c_i \in C$  contained in the formula in  $\{a_{n+1}, \dots, a_m\}$ . Each of these is interpreted as a name for a natural number. Hence let  $b$  be interpreted as one of the  $b' >$  all of the  $c'_i$ . Consequently,  $\mathcal{M}_I \models A$ . Thus from the compactness theorem there is a structure  $^*\mathcal{M}_I$  that behaves in  $Pd_b$  like the natural numbers but contains a type of natural number that is “greater than” all of the original natural numbers.

2. Let  $\mathbb{R}$  denote the set of all real numbers. Let  $C$  be a set of constants naming each member of  $\mathbb{R}$  and suppose that  $Pd$  is the language that describes the real numbers. Suppose that  $b$  is a constant not a member of  $C$ . Let  $\Gamma$  be the theory of real numbers. Let  $Q(0, y, x)$  be the 3-place predicate that corresponds to the definable real number 3-place relation  $0' < c' < d'$ , where  $0', c', d' \in \mathbb{R}$ . Now in the real numbers there is a set of elements  $G'$  such that each member  $c'$  of  $G'$  has the property that  $0' < c'$ . Let  $G$  be the set of constants

that correspond to the members of the set  $G'$ . Consider the set of sentences  $\Phi = \{Q(0, b, g) \mid g \in G\}$  in the language  $Pdb$ . Give an argument that shows that there exists a structure  $^*\mathcal{M}_I$  such that  $^*\mathcal{M}_I \models \Gamma \cup \Phi$ . That is there exists a mathematical domain  $D$  that behaves like the real numbers, but  $D$  contains a member  $b'$  such that  $b'$  is “greater than zero” but  $b'$  is “less than” every one of the original positive real numbers.

Well, simply consider any finite subset  $A$  of  $\Gamma \cup \Phi$ . Suppose that  $\{a_1, \dots, a_n\} \subset A$  and that  $\{a_1, \dots, a_n\} \subset \Gamma$ . Let  $\mathcal{M}_I \models \Gamma$ , where  $\mathcal{M}_I \models$  models all of the theory definable predicts as well. Then  $\mathcal{M}_I \models \{a_1, \dots, a_n\}$ . Now suppose that  $\{a_{n+1}, \dots, a_m\}$  are the remaining members of  $A$  that are not in  $\Gamma$ . Now each member of  $\{a_{n+1}, \dots, a_m\}$  is of the form  $Q(0, b, g)$  where  $g \in G$  is interpreted as a real number greater than  $0'$ . Since, in this case the  $g$  represent a finite set of such real numbers, then one of these real numbers, say  $g'_1$ , is the “smallest one” with respect to  $<'$ . Now consider the real number  $g'_1/2$  and let  $b$  be interpreted as this real number. Then  $\mathcal{M}_I \models \{a_{n+1}, \dots, a_m\}$ . Hence we have that  $\mathcal{M}_I \models A$ . The compactness theorem states that there is a structure  $^*\mathcal{M}_I$  that behaves, in  $Pdb$ , like the real numbers. And, there exists in the structure a real like number  $b'$  such that  $0' <' b' <' g'$  for all of the original real numbers  $g'$  such that  $0' <' g'$ .

### Discussion

In what follows prime notation has been charged to \*

[1] (Note that we don't mention the “constant” in the structure notation since we have originally assigned all members of the domain and some members of the new domain constant names.) In the structure  $^*\mathcal{M}_I = \langle ^*\mathbb{N}, ^*+, ^*=, ^*<, \dots \rangle$  all the usual properties that can be expressed in a the appropriate first-order language hold for  $^*\mathcal{M}_I$ . One extremely useful additional property that one would like  $^*\mathcal{M}_I$  to possess is the embedding property. Is there a subset of  $^*\mathbb{N}$  that can be used in every way as the natural numbers themselves where the \* operators restricted to this subset have the same properties as the original natural numbers? After some effort in model theory, the answer is yes. Thus we can think of the natural numbers  $\mathbb{N}$  as a “substructure” of the  $^*\mathcal{M}_I$ . The interesting part of all of this is that a simple comparison of properties can now be made. If there is one natural number  $^*b$  then you can consider the set of all such members of  $^*\mathbb{N}$ . This set is denoted by  $\mathbb{N}_\infty$  and is called the set of all “infinite natural numbers.” It has a algebra that behaves as Newton wished for such objects. For example, if  $\lambda, \beta \in \mathbb{N}_\infty$  and nonzero  $n \in \mathbb{N}$ , then  $n\lambda + \beta \in \mathbb{N}_\infty$ . Further, for any  $n \in \mathbb{N}$ , we have that  $\lambda - n \in \mathbb{N}_\infty$ , [can you show this?] where we now think of  $\mathbb{N}$  as the non-negative integers. But  $^*\mathbb{N}$  has a property that no set of natural numbers has and this property is why the set  $^*\mathbb{N}$  cannot be “graphed” in the usual manner. Every nonempty subset of  $\mathbb{N}$  has a first element. This means that if nonempty  $A \subset \mathbb{N}$ , then there is some  $a \in A$  such that  $a \leq x$  for all  $x \in A$ . But the set  $\mathbb{N}_\infty$  does not have a first element with respect to  $^*<$ . Suppose that  $\mathbb{N}_\infty$  does have a first element  $\lambda_1$ . Then if you establish what has been written above, since the same basic properties for  $^*<$  hold as they do for  $<$ , we have that  $\lambda_1 - 1 \ ^*< \lambda_1$ , which contradicts the concept of first element with respect to  $^*<$ . Indeed, a recent published paper that I am reviewing, has forgotten this simple fact.

[2] The structure here  $^*\mathcal{M}_I = \langle ^*\mathbb{R}, ^*+, ^*, ^*<, \dots \rangle$  can have  $\mathcal{M}_I = \langle \mathbb{R}, +, \cdot, <, \dots \rangle$  embedded into it in such a manner that  $\mathcal{M}_I$  is a substructure of  $^*\mathcal{M}_I$ . And, as in [1], this substructure behaves relative to the all the properties of the first-order theory of real numbers just like the real numbers. In this case, we have that  $^*0 = 0 \ ^*< \ ^*b \ ^*< r$  for each positive real number  $r \in \mathbb{R}$ . Now we consider the entire set of all such  $^*b$  and call this the set of positive infinitesimals  $\mu(+0)$ . Since all the algebra holds one adjoins to this set the 0 and  $\{-\epsilon \mid \epsilon \in \mu(+0)\} = \mu(0)$ . Do these satisfy the theory of the “infinitely small” of Newton? Well, here are a few properties. First, the normal arithmetic of the real numbers holds for  $\mu(0)$ . This we have that if  $\epsilon \in \mu(+0)$ , then  $1/\epsilon \ ^*> r$  for any  $r \in \mathbb{R}$ . Also when Newton had an object he called infinitely small and squared it he claimed that this was “more infinitely small” in character. Well,  $0 \ ^*< \epsilon^2 \ ^*< \epsilon$  and they are not equal. Then Newton claimed that if he took any real number and multiplied it by an infinitely small number that the result was still infinitely small. One can establish that for each  $r \in \mathbb{R}$ , we have that  $r \ ^*\epsilon \in \mu(0)$ . Indeed, we can establish that if  $f$  is any function defined on  $\mathbb{R}$ , continuous at  $r = 0$  and  $f(0) = 0$ , then all the properties of  $f$  hold for  $\epsilon$  and when they are applied to  $\epsilon$  the result is always an infinitesimal. There is no where in the use of the Calculus that these infinitesimals contradict the intuitive procedures used by mathematicians through 1824. Their properties also correct the error discovered in 1824 that led to the introduction of the limit concept.

## A

and-gate 29.  
assignment 15.  
atomic formula,  
  propositional 13.  
  predicate 64.  
  first-order language 64.  
atoms,  
  propositional 9, 10.  
  predicate 63.  
  first-order language 63.

## B

binary 9,  
  relation 22.  
bound occurrence of the constant  
  68.

## C

closed formula 69.  
common pair 15, 13,  
  rule 13.  
complete set 59.  
composite formula 64.  
congruent formula 69.  
connectives 9.  
consequence,  
  of  $\Gamma$  57.  
  consequence operator 55.  
consistent,  
  propositional 39.  
  predicate, first-order 91.  
constants, insertion of 63, 57.  
contradiction,  
  propositional 39.  
  predicate, first-order 91.  
countermodel 76.

## D

deduction,  
  from a set of  $\Gamma$  45.  
deductive processes 98.  
deductive system 59.  
demonstration 45.  
denial 26.  
descriptions 98.  
domain for a structure 72.  
equality 22.

## E

equivalence relation 23.  
existential quantifier 64.  
extralogical symbols 10.

## F

formal demonstration,  
  first-order, 86.  
formal proof, propositional 42,  
  43.  
formally consistent,  
  predicate 91.  
  propositional 57.  
formula variables,  
  predicate 64.  
  propositional 39.  
formulas,  
  predicate 63.  
  propositional 9.  
free for  $x$  in  $A$  77.  
free in the formula 68.  
free substitution operator 72.  
full disjunctive normal form 27.  
fundamental conjunction 28.

## G

generalization, first-order 86.

## H

hypotheses, premises 32.  
hypothetical syllogism 44.

## I

induction 102.  
inconsistent,  
  predicate, first-order 91.  
  propositional 39.  
interpretation metasymbol 10.  
interpretation, for first-order  
  structure 72.  
inverter 29.

## L

language levels 9.  
logic circuits 29.  
logical connectives 10.  
logical flow 29.

## M

meta - 6.  
model theory, propositional 35.  
modus ponens 43.  
model, first-order 73.

## N

names domain members, first-order 94.  
Natural event 98.  
Natural system 97.  
negation complete 91.  
normally closed, switch 14.  
normally open, switch 14.  
not a model 73.  
not satisfied 33.

## O

observer language 6.  
or-gate 29.

## P

predicates 63,  
  1-place predicates 63.  
  2-place predicates 63.  
  3-place predicates 63.  
  n-place 63.  
premises, hypotheses 32.  
prenex normal form 82.

## R

relative consistency 85.

## S

satisfiable,  
  propositional 33, 38, 57  
  predicate, first-order 93.  
satisfy = satisfiable  
scope, 64  
  of that quantifier 67.  
semantical modus ponens 24.  
semantical 19.  
semantics 15.  
sentence 69.  
set of all sentences 71.  
simply consistent, propositional  
  39.  
size of a formula 11, 64.  
standard theory 100.

standard model 100.  
stronger than for consequence  
  operators 55.  
structure, first-order 72.  
subformula 24.  
substitution process,  
  propositional 20.

## T

theorem, formal,  
  predicate, first-order 86.  
  propositional 42.  
truth-table 15 - 17.

## U

ultralogic 100.  
ultraword 100.  
unary connective 10.  
unique equivalent form 27.  
universal closure 76.  
universal quantifier 64.  
universal, formula called 106.

## V

valid consequence of  $\Gamma$ ,  
  propositional 57.  
valid consequence,  
  predicate, first-order 82.  
  propositional 33, 57.  
valid,  
  predicate, first-order 82.  
  propositional 19.  
valuation procedure, 16.  
  in general for propositional 57.  
variable predicate forms 63, 77  
variable substitution,  
  propositional 40.  
variables, predicate 63 - 64.

## W

wffs = well formed formula 9.  
well-ordered 102.